

# GROUND BEAM 5 R60

## ΠΕΡΙΕΧΟΜΕΝΑ | CONTENTS

Datasheet ..... 1  
Manual ..... 3

SKU: **GR5R60-** XX-XX-XX-XX-XX-XX-XX-XX

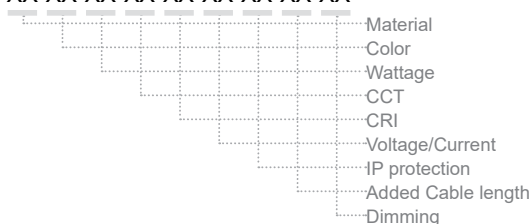

## DATASHEET



### GENERAL INFORMATION

APPLICATION:	Indoor / Outdoor
MOUNTING SURFACE:	Ground
MOUNTING TYPE:	Surface Mounted
VISIBLE DIMENSIONS:	Ø 60 × L 22 mm
CABLE INCLUDED:	30 cm
LED:	Cree / OSRAM
LIFE TIME:	50000 hours
WARRANTY:	3 years (*5 years upon request)
ORIGIN:	Greece









### CONFIGURATION OPTIONS

#### \*MATERIAL:

Aluminium	(01)	
Inox	(02)	
Brass	(03)	
Copper	(06)	

#### \*COLOR:

Anodised (Aluminium only)	(AN)	
Black	(BL)	
White	(WH)	
Graphite	(GF)	
RAL colors	(RL)	
Patina	(PT)	
No color	(NO)	

#### \*WATTAGE:

0.5W	(0.5W)
1W	(1W)
2W	(2W)
2.5W	(2.5W)
3W	(3W)
4W	(4W)

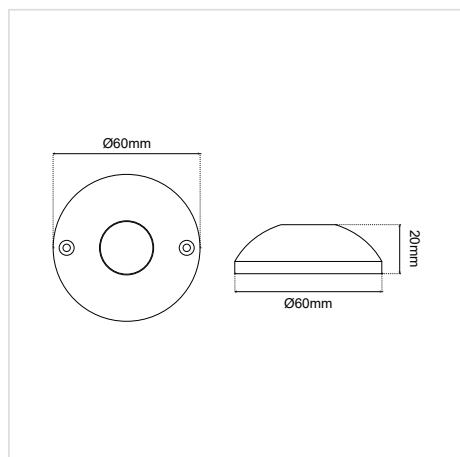





















Continued on next page →

# GROUND BEAM 5 R60

SKU: **GR5R60-XX-XX-XX-XX-XX-XX-XX-XX-XX**

MATERIAL  
COLOR  
WATTAGE  
CCT  
CRI  
VOLTAGE/CURRENT  
IP PROTECTION  
ADDED CABLE LENGTH  
DIMMABLE

## CONFIGURATION OPTIONS (cont.)

*CCT:		*CRI:		OUTPUT:	*VOLTAGE/CURRENT:		*BEAM ANGLE:		*IP PROTECTION:			
2200K	<b>(22K)</b>		Ra80	<b>(80)</b>	70 lm/W	12VDC	<b>(V1)</b>	Diffused	<b>(DF)</b>		IP20	<b>(20)</b>
			Ra90	<b>(90)</b>	56 lm/W	24VDC	<b>(V2)</b>	10D	<b>(10D)</b>		IP54	<b>(54)</b>
2700K	<b>(27K)</b>		Ra80	<b>(80)</b>	100 lm/W	230VAC	<b>(V3)</b>	20D	<b>(20D)</b>		IP65	<b>(65)</b>
			Ra90	<b>(90)</b>	80 lm/W	12/24V	<b>(V4)</b>	25D	<b>(25D)</b>		IP67	<b>(67)</b>
3000K	<b>(30K)</b>		Ra80	<b>(80)</b>	110 lm/W	350mA	<b>(V5)</b>	36D	<b>(36D)</b>			
			Ra90	<b>(90)</b>	88 lm/W	500mA	<b>(V6)</b>	40D	<b>(40D)</b>			
4000K	<b>(40K)</b>		Ra80	<b>(80)</b>	120 lm/W			54D	<b>(54D)</b>			
			Ra90	<b>(90)</b>	96 lm/W			60D	<b>(60D)</b>			
5000K	<b>(50K)</b>		Ra80	<b>(80)</b>	120 lm/W			25x45D	<b>(2545D)</b>			
			Ra90	<b>(90)</b>	96 lm/W							
6000K	<b>(60K)</b>		Ra80	<b>(80)</b>	125 lm/W							
			Ra90	<b>(90)</b>	100 lm/W							
Red	<b>(R)</b>											
Green	<b>(G)</b>											
Blue	<b>(B)</b>											
Amber	<b>(A)</b>											
RGB	<b>(C1)</b>											

### \*ADDED CABLE LENGTH:

1m	<b>(1m)</b>	2m	<b>(2m)</b>
3m	<b>(3m)</b>	4m	<b>(4m)</b>
5m	<b>(5m)</b>	6m	<b>(6m)</b>
7m	<b>(7m)</b>	8m	<b>(8m)</b>
9m	<b>(9m)</b>	10m	<b>(10m)</b>
No Added Cable		<b>(NAC)</b>	

### \*DIMMING:

Dimmable	<b>(D)</b>
On/Off	<b>(_)</b>

\* Υποχρεωτική επιλογή / Mandatory option

ΔΗΜΙΟΥΡΓΙΑ ΚΩΔΙΚΟΥ ΠΡΟΪΟΝΤΟΣ / PRODUCT CODE GENERATOR:

**GR5R60 - Material - Color - Wattage - CCT - CRI - Voltage/Current - Beam angle - IP protection - Added cable Length - Dimming**

ΠΑΡΑΔΕΙΓΜΑ / EXAMPLE:

**GR5R60-01-AN-1W-30K-80-V2-35D-20-NAC-\_-**

for GROUND BEAM 5 R60, Aluminium, Anodized, 1W, 3000K, Ra80, 24VDC, 35D, IP20, No added cable, On/Off

## GROUND BEAM 5 R60 MANUAL

### ΟΔΗΓΙΕΣ ΕΓΚΑΤΑΣΤΑΣΗΣ INSTALLATION INSTRUCTIONS

#### ΣΗΜΑΝΤΙΚΟ:

Αυτό το εξάρτημα πρέπει να εγκατασταθεί από εξειδικευμένο ηλεκτρολόγο.

Η BarisLight δεν φέρει ευθύνη για τυχόν ζητήματα που προκύπτουν από ακατάλληλη εγκατάσταση που δεν συμμορφώνεται με τα τοπικά πρότυπα ασφαλείας.

Παρακαλούμε δώστε ένα αντίγραφο αυτών των οδηγιών στο άτομο που είναι υπεύθυνο για τη συντήρηση της εγκατάστασης.

### ΣΥΝΔΕΣΗ ΜΕ ΤΗΝ ΗΛΕΚΤΡΙΚΗ ΠΑΡΟΧΗ CONNECTION TO THE ELECTRICAL SUPPLY

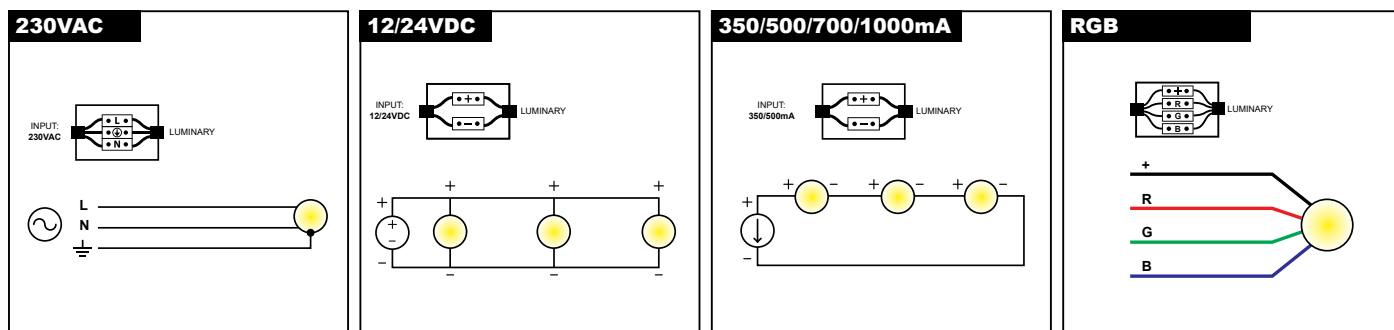

#### Διαδικασία καλωδίωσης

1. Κλείστε τον κεντρικό διακόπτη ρεύματος.
2. Συνδέστε τα φωτιστικά στη μονάδα παροχής ρεύματος.
3. Συνδέστε τη μονάδα τροφοδοσίας στο ηλεκτρικό δίκτυο.
4. Ενεργοποιήστε τον κεντρικό διακόπτη ρεύματος.

**Σημείωση ασφαλείας:** Βεβαιωθείτε ότι ο κεντρικός διακόπτης λειτουργίας είναι απενεργοποιημένος κατά τη διάρκεια όλων των διαδικασιών συντήρησης και εγκατάστασης.

**Προειδοποίηση:** Αποφύγετε τη σύνδεση πάρα πολλών φωτιστικών παράλληλα σε μία μόνο μονάδα τροφοδοσίας για να αποφευχθεί η υπερφόρτωση.

#### IMPORTANT:

This luminaire must be installed by a qualified electrician.

#### Disclaimer:

BarisLight is not liable for any issues arising from improper installation that does not comply with local safety standards.

#### Instructions:

Please provide a copy of these instructions to the person responsible for maintaining the installation.

#### Wiring Procedure

1. Turn off the main power switch.
2. Connect the luminaires to the power supply unit.
3. Connect the power supply unit to the electrical network.
4. Turn on the main power switch.

**Safety Notice:** Ensure the main power switch is turned off during all maintenance and installation procedures.

**Warning:** Avoid connecting too many luminaires in parallel to a single power supply unit to prevent overloading.

## GROUND BEAM 5 R60 MANUAL

### Τοποθέτηση στο έδαφος Installation in the ground

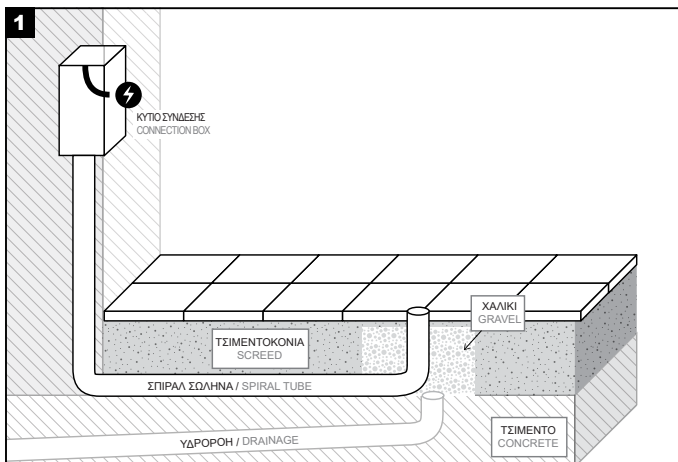

Συνδέστε τον σπирάλ σωλήνα στο κουτί σύνδεσης.  
Κάθε φωτιστικό διαθέτει τον δικό του ξεχωριστό σπирάλ σωλήνα.  
Η υδροροή απαιτείται μόνο για εξωτερικές εγκαταστάσεις, δεν είναι απαραίτητη για εσωτερικούς χώρους.

Connect the spiral tube to the junction box.  
Each luminaire has its own separate spiral tube.  
Drainage is required only for outdoor installations, it is not necessary for indoor use.

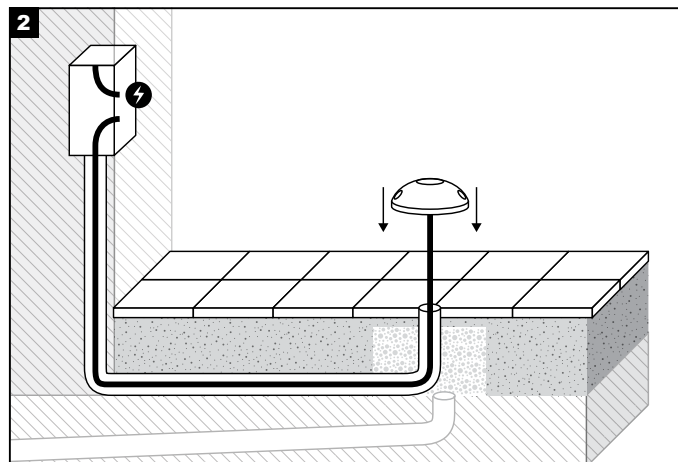

Περάστε το καλώδιο του φωτιστικού μέσα από τον σπирάλ σωλήνα μέχρι να φτάσει στο κουτί σύνδεσης.  
Βεβαιωθείτε ότι το φωτιστικό έχει παραγγελθεί με μήκος καλωδίου αρκετό ώστε να φτάνει μέχρι το κουτί σύνδεσης.

Feed the luminaire's cable through the spiral conduit until it reaches the connection box.  
Make sure to order the luminaire with a cable long enough to reach the connection box.

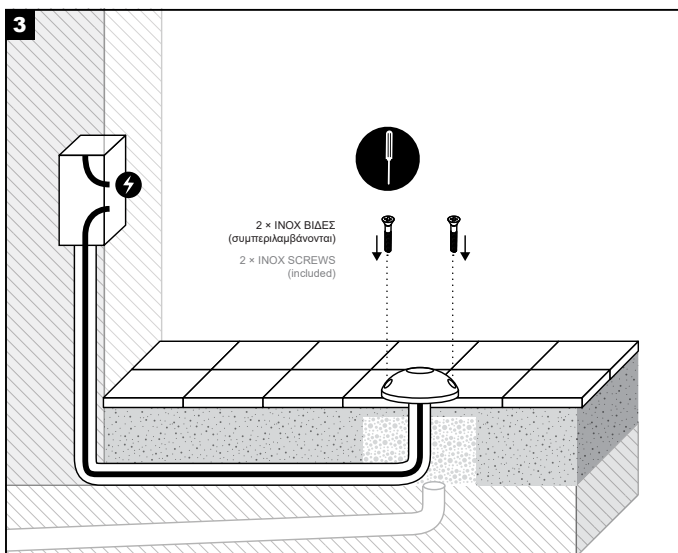

Εφαρμόστε το φωτιστικό στην επιφάνεια και βιδώστε το μέχρι να σταθεροποιηθεί στο έδαφος.

Apply the luminaire on the surface and secure it by screwing it in until it is firmly fixed to the ground.

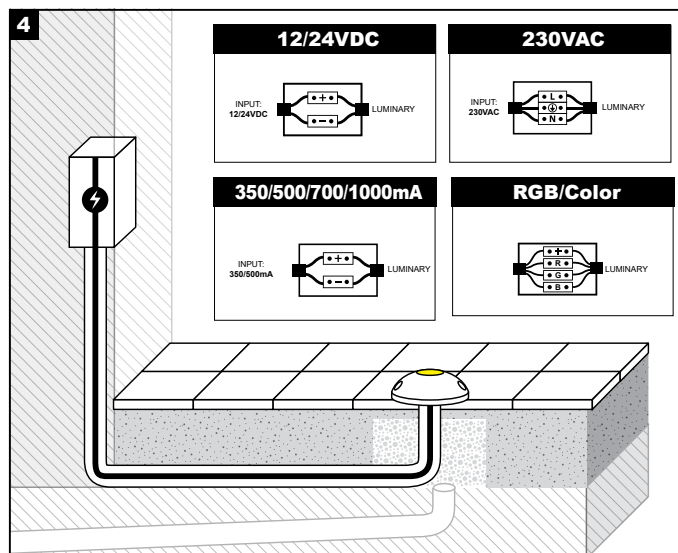

Εφαρμόστε το φωτιστικό στο χωνευτό κουτί εγκατάστασης και συνδέστε το καλώδιο του φωτιστικού με την ηλεκτρική παροχή.

Apply the luminaire in the recessed installation sleeve and connect the cable of the luminaire with the electrical supply.

## GROUND BEAM 5 R60 MANUAL

