



Features:

- Input voltage: 110/220V by switch
- Protection: Shortcircuit/overload/overvoltage/overheat
- Working temperature with 60°C
- Cooling by free air convection
- 100% full load burn-in test
- 3 years warranty

CE RoHS BIS SELV IP20 

Specification:

Model		HRM-250-12	HRM-250-24
Output	Voltage DC	12V	24V
	Voltage Tolerance	±0.5V	±0.5V
	Current Range	20.8A	0 - 10.4A
	Rated Current	20.8A	10.4A
	Rated Power	250W	250W
	Ripple & Noise(Max.)	200mVp-p	200mVp-p
	Line Regulation	±0.5% at full load	±0.5% at full load
	Load Regulation	±0.5% at full load	±0.5% at full load
	Setup, Rise Time	500ms,80ms/230V at full load	500ms,80ms/230V at full load
	Hold-up Time	50ms /230VAC at full load	50ms /230VAC at full load

Input	Voltage Range	110/220V by switch	
	Frequency Range	50 - 60Hz	
	Leakage Current	< 0.5mA/260VAC	
	Inrush Current	≤ 60A	
	Power Factor	pf ≈ 0.55 /230VAC at full load	
	AC Current(Max.)	2.1A/230VAC 4.26A/115VAC	
	Efficiency(typ.)	85%	86%
Protection	Short Circuit	Protection type:Hiccup mode,recovers automatically after fault condition is removed	
	Over Load	Hiccup mode, recovers automatically after fault condition is removed	
	Burnt-in Test	Input voltage:220V 50Hz rated output current 25°C Bum-in 2h	
Environment	Vibration	10-500Hz,5G 12min./1 cycle, period for 60min. each along x,y,z axes	
	Over Temperature	100°C±10 °C shut down o/p voltage,re-power on to recover	
	Start Rise Hold Time	1500ms,20ms,50ms/230VAC at full load	
	Working Humidity	20~60%RH,non-condensing	
	Storage TEM, Humidity	-20 ~ +85%,10 ~ 95%RH	
	Working TEMP.	-20 ~ +50°C	
Safety & EMC	Safety Standards	CE Mark	
	Withstand Voltage	I/P-O/P:1.5KVAC I/P-GND:1.5KVAC	
	EMC Immunity	EN55015:2013;EN61547:2009; EN61000-3-2:2014; EN61000-3-3:2013	
Others	Weight	600g	
	Package	20pcs/CTN	
	Dimension	215x115x30mm(LxWxH)	
Notes	<ol style="list-style-type: none"> All parameters not specially mentioned are measured at 230VAC input , rated load and 25°C of ambient temperature. Tolerance: includes set up tolerance, line regulation and load regulation. Ripple & noise are measured at 20MHz of bandwidth by using a 12" twisted pair-wire terminated with a 0.1uf & 47uf parallel capacitor. The power supply is considered as a component that will be operated in combination with final equipment. Since EMC performance will be affected by the complete installation, the final equipment manufactures must be-qualify EMC directive on the complete installation again. Length of set up time is measured at cold first start. Turning on/off the power supply very quickly may lead to increase of the set up time. 		

Mechanical Specification:

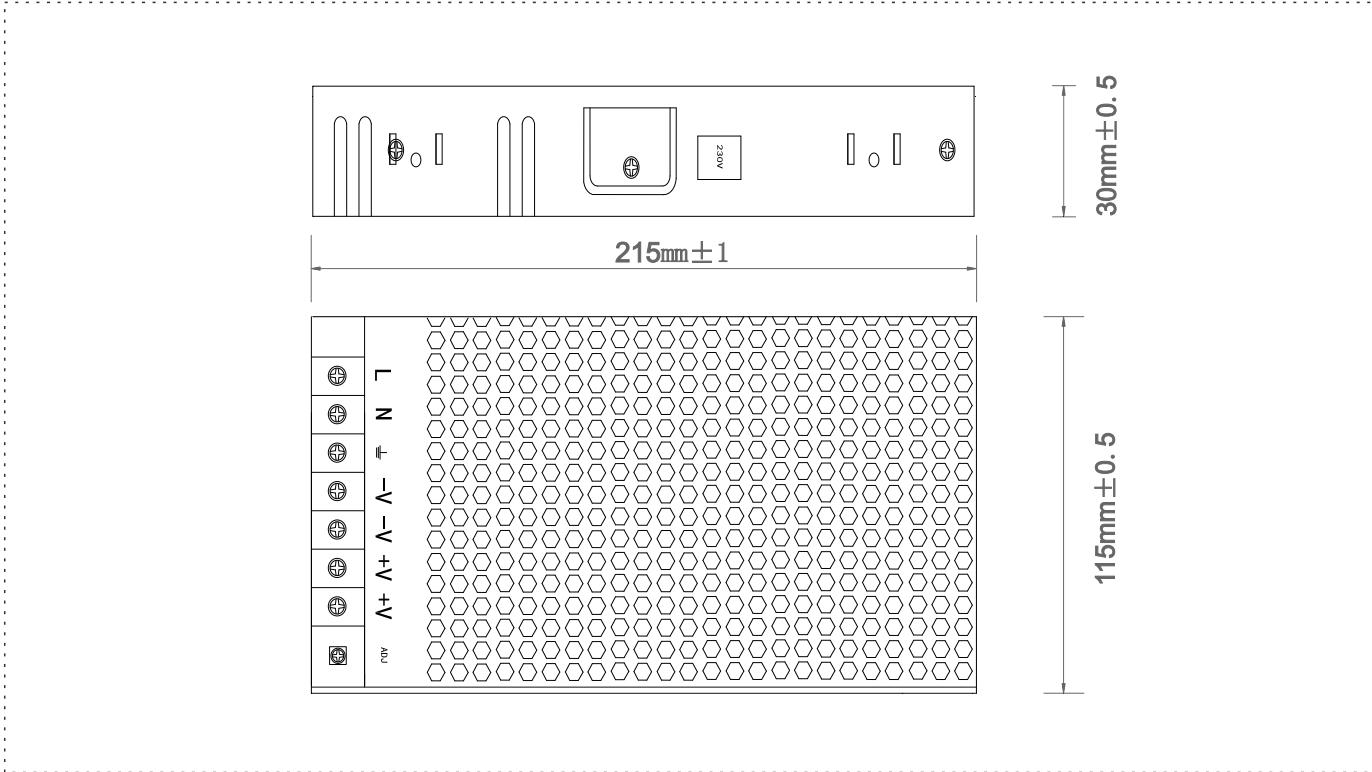

Switching Time Curve:

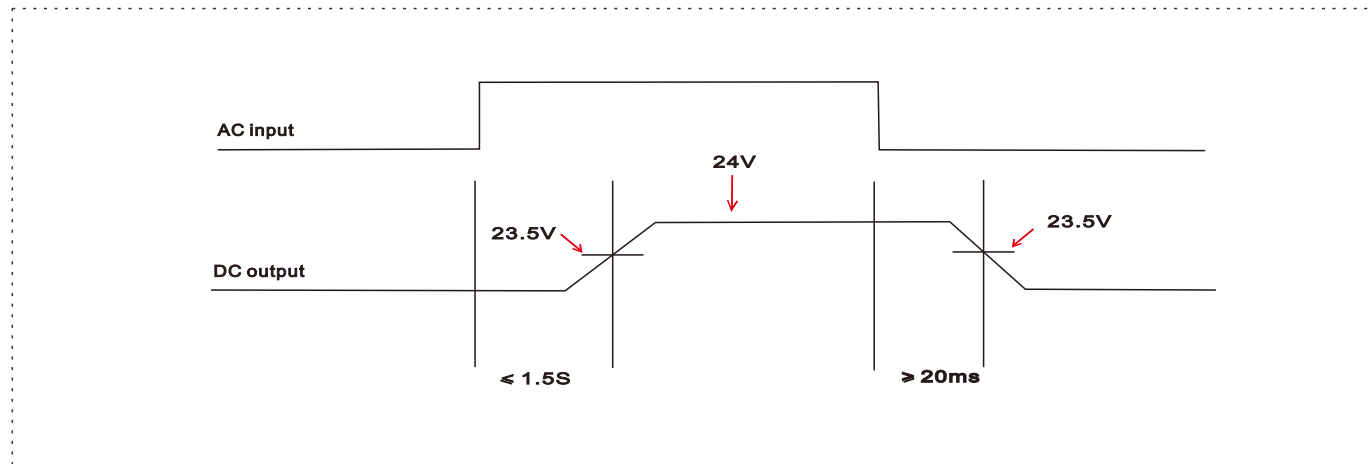

Block Diagram:

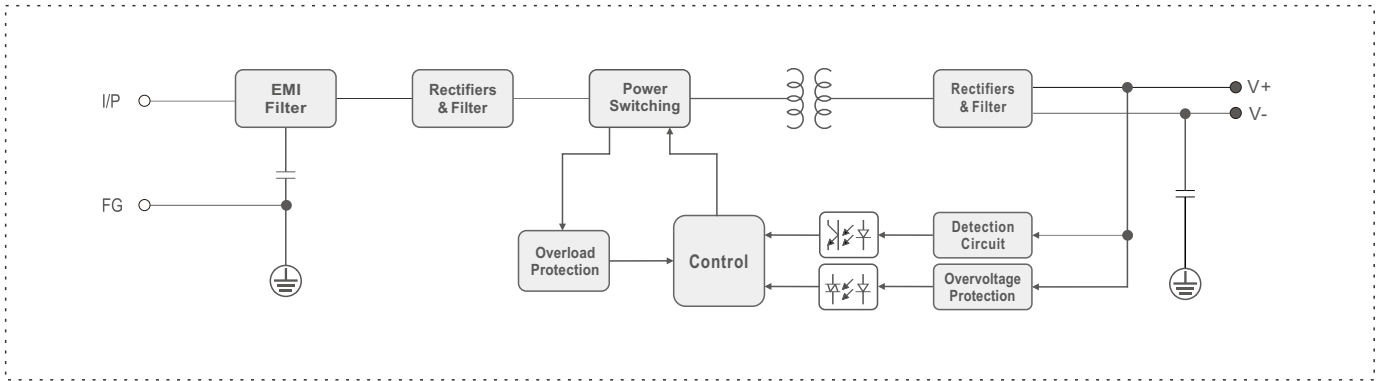

Derating Curve:

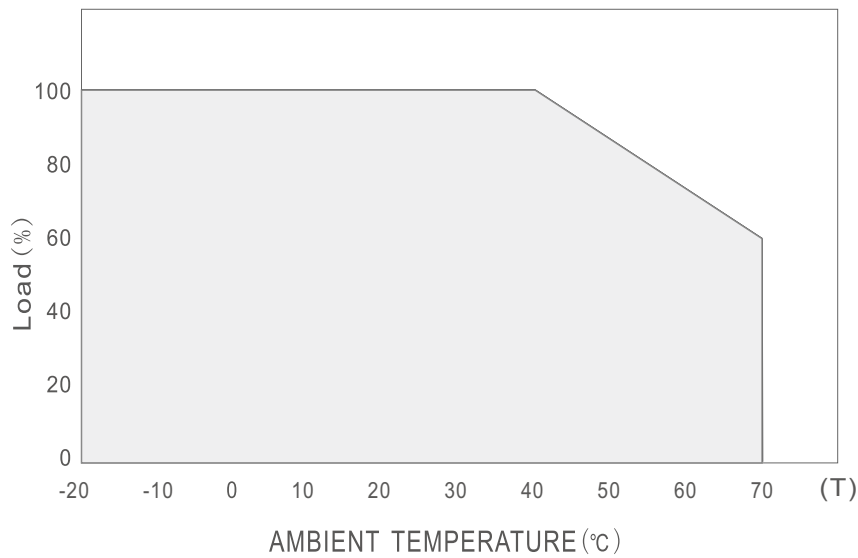

Package details:

Weight:	600g/PCS,12.8kg/CTN
Quantity:	20PCS/Carton
Carton Size:	63x23.9x23.5CM
Product Size:	215x115x30mm(LxWxH)

Wiring Diagram:

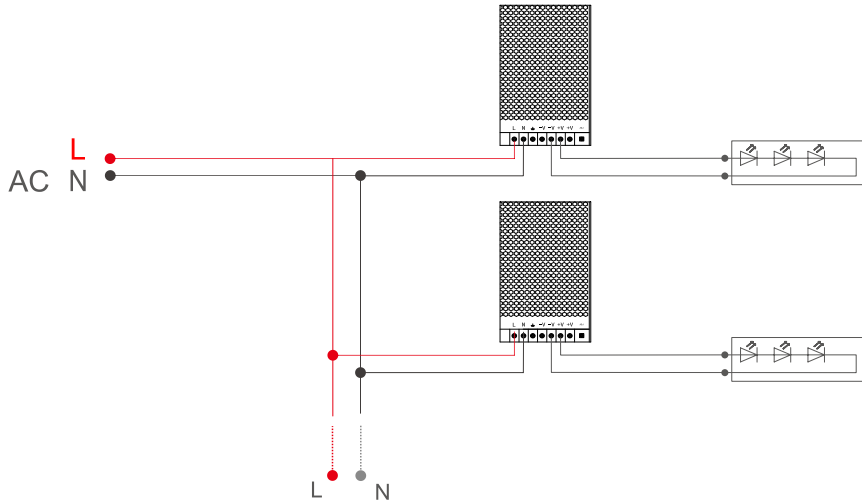

Installation Notes:

- ※1. The distance between two products should be $< 10\text{cm}$, so as not to affect heat dissipation and the lifespan of the products.
- ※2. The distance between products and the LED input terminal should be < 5 meters.

At least 10 cm spacing:

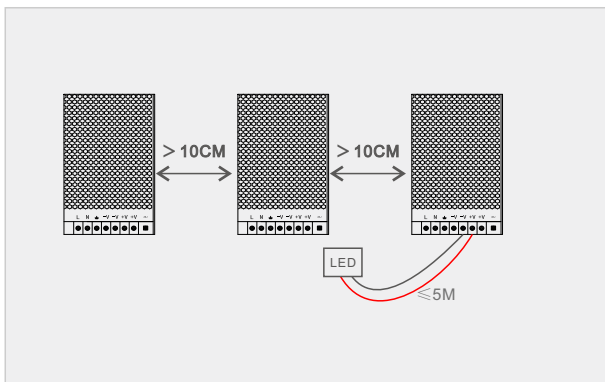

Not to be installed closely:

