

GILA 35x35 TRIMLESS / Datasheet

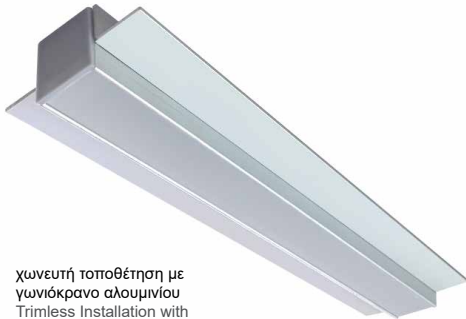

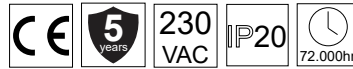

Χωνευτή τοποθέτηση με
γωνιόκρανο αλουμινίου
Trimless Installation with
aluminium angular

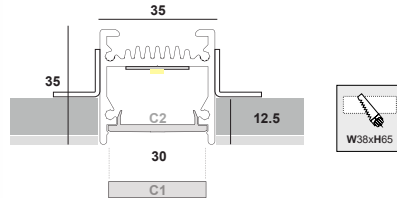

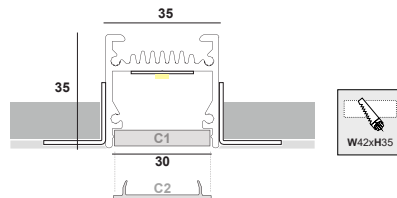
Χωνευτή τοποθέτηση με
πλαστικό γωνιόκρανο
Trimless Installation with
plastic angular



material	Pcb details	CRI	lumen output / W
Extruded aluminium	Zhaga-Compliant Dimensions	Ra>80 (Ra>90 on request)	up to 195 Lm/W

covers	CCT	Dimming options
 Slide Diffuser 5mm (-C1-)	3000K (3)	Push
	4000K (4)	DALI
	5000K (5)	TRIAC 0/1-10V
 Click diffuser 1.5mm (-C2-) (up to 70m reel)	6500K (6)	CASAMBI
		Analog 0/1-10V

T35 - XX - XXX - X - XX - X - X

(a)	(b)	(c)	(d)	(e)	(f)	(g)
Κωδικός Γραμμικού Linear Code	Κατηγορία Category	Μήκος Length	Θερμοκρασία φωτός Color Temperature	Κάλυμμα Cover	Αυτομείωση έντασης φωτός Dimming	Χωνευτή τοποθέτηση Trimless installation

ΠΕΡΙΕΧΟΜΕΝΑ

Datasheet	1
Product Code generator	2
Lumen output tables	3
Οδηγίες χωνευτής τοποθέτησης με γωνιόκρανο αλουμινίου	4
Οδηγίες χωνευτής τοποθέτησης με πλαστικό γωνιόκρανο	5

GILA 35x35 TRIMLESS / Code Generator

a. **T35-**

b. Κατηγορία απόδοσης / Output category

Ανατρέξτε στους πίνακες των γραμμικών και διαλέξτε την απόδοση που απαιτεί ο χώρος σας. Η ισχύς προκύπτει από την κατηγορία απόδοσης (**1A / 1B / 2A / 2B**) και από τη θερμοκρασία φωτός (**3000K / 4000K / 5000K / 6500K**) που θα επιλέξετε.
Refer to the linear tables and choose the output that your space requires. Wattage follows from the output category (**1A / 1B / 2A / 2B**) and the Kelvins (**3000K / 4000K / 5000K / 6500K**) you choose.

 <p>1A (13,5 W/m) 1B (20 W/m)</p>	 <p>2A (40,5 W/m) 2B (60,5 W/m)</p>
--	---

c. Μήκος / length

Διατίθεται και σε μήκη έως 600cm. / Available in lengths up to 600cm.

length	code	length	code	length	code	length	code
60cm	-60-	180cm	-180-	300cm	-300-	420cm	-420-
90cm	-90-	210cm	-210-	330cm	-330-	450cm	-450-
120cm	-120-	240cm	-240-	360cm	-360-	480cm	-480-
150cm	-150-	270cm	-270-	390cm	-390-		

d. Θερμοκρασία φωτός / Kelvin

 <p>3000K warm white (-3-)</p>	 <p>4000K neutral white (-4-)</p>	 <p>5000K cold white (-5-)</p>	 <p>6500K ultra cold white (-6-)</p>
--	---	---	--



e. Κάλυμμα / cover

 <p>Slide Diffuser (-C1-)</p>	 <p>Click diffuser 1,5mm (-C2-) (up to 70m reel)</p>
---	--

f. Αυξομείωση έντασης φωτός \ Dimming option

 <p>Yes (D) No (_)</p>

g. Χωνευτή τοποθέτηση \ Trimless Installation

 <p>Με πλαστικό γωνιόκρανο (-P-) With plastic angular</p>	 <p>Με πλαστικό γωνιόκρανο (-M-) With plastic angular</p>
---	---

T35 - XX - XXX - X - XX - X - X
 (a) (b) (c) (d) (e) (f) (g)
 Κωδικός Γραμμικού Linear Code Κατηγορία Category Μήκος Length Θερμοκρασία φωτός Color Temperature Κάλυμμα Cover Αυξομείωση έντασης φωτός Dimming Χωνευτή τοποθέτηση Trimless installation

Παράδειγμα κωδικού / Code example

GILA 35x35 TRIMLESS 1A 90cm 3000K Diffuser 1,5m Dimmable with Plastic Angular
SKU: T35-1A-90-3-C2-D-P

GILA 35x35 TRIMLESS / Lumen output tables

CATEGORY 1A 350mA (1A)	code	length	watt	lumens 3000K	lumens 4000K	lumens 5000K	lumens 6500K
	T35-1A-60	60cm	7,8	1390	1470	1470	1440
	T35-1A-90	90cm	11,7	2085	2205	2205	2160
	T35-1A-120	120cm	15,6	2780	2940	2940	2880
	T35-1A-150	150cm	19,5	3475	3675	3675	3600
	T35-1A-180	180cm	23,4	4170	4410	4410	4320
	T35-1A-210	210cm	27,3	4865	5145	5145	5040
	T35-1A-240	240cm	31,2	5560	5880	5880	5760
	T35-1A-270	270cm	35,1	6255	6615	6615	6480
	T35-1A-300	300cm	39	6950	7350	7350	7200
	T35-1A-330	330cm	42,9	7645	8085	8085	7920
	T35-1A-360	360cm	46,8	8340	8820	8820	8640
	T35-1A-390	390cm	50,7	9035	9555	9555	9360
	T35-1A-420	420cm	54,6	9730	10290	10290	10080
	T35-1A-450	450cm	58,5	10425	11025	11025	10800
	T35-1A-480	480cm	62,4	11120	11760	11760	11520

CATEGORY 1B 500mA (1B)	code	length	watt	lumens 3000K	lumens 4000K	lumens 5000K	lumens 6500K
	T35-1B-60	60cm	11,6	1960	2070	2070	2020
	T35-1B-90	90cm	17,4	2940	3105	3105	3030
	T35-1B-120	120cm	23,2	3920	4140	4140	4040
	T35-1B-150	150cm	29	4900	5175	5175	5050
	T35-1B-180	180cm	34,8	5880	6210	6210	6060
	T35-1B-210	210cm	40,6	6860	7245	7245	7070
	T35-1B-240	240cm	46,4	7840	8280	8280	8080
	T35-1B-270	270cm	52,2	8820	9315	9315	9090
	T35-1B-300	300cm	58	9800	10350	10350	10100
	T35-1B-330	330cm	63,8	10780	11385	11385	11110
	T35-1B-360	360cm	69,6	11760	12420	12420	12120
	T35-1B-390	390cm	75,4	12740	13455	13455	13130
	T35-1B-420	420cm	81,2	13720	14490	14490	14140
	T35-1B-450	450cm	87	14700	15525	15525	15150
	T35-1B-480	480cm	92,8	15680	16560	16560	16160

CATEGORY 2A 350mA (2A)	code	length	watt	lumens 3000K	lumens 4000K	lumens 5000K	lumens 6500K
	T35-2A-60	60cm	23,6	4080	4380	4380	4080
	T35-2A-90	90cm	35,4	6120	6570	6570	6120
	T35-2A-120	120cm	47,2	8160	8760	8760	8160
	T35-2A-150	150cm	59	10200	10950	10950	10200
	T35-2A-180	180cm	70,8	12240	13140	13140	12240
	T35-2A-210	210cm	82,6	14280	15330	15330	14280
	T35-2A-240	240cm	94,4	16320	17520	17520	16320
	T35-2A-270	270cm	106,2	18360	19710	19710	18360
	T35-2A-300	300cm	118	20400	21900	21900	20400
	T35-2A-330	330cm	129,8	22440	24090	24090	22440
	T35-2A-360	360cm	141,6	24480	26280	26280	24480
	T35-2A-390	390cm	153,4	26520	28470	28470	26520
	T35-2A-420	420cm	165,2	28560	30660	30660	28560
	T35-2A-450	450cm	177	30600	32850	32850	30600
	T35-2A-480	480cm	188,8	32640	35040	35040	32640

CATEGORY 2B 500mA (2B)	code	length	watt	lumens 3000K	lumens 4000K	lumens 5000K	lumens 6500K
	T35-2B-60	60cm	35	5700	6140	6140	5700
	T35-2B-90	90cm	52,5	8550	9210	9210	8550
	T35-2B-120	120cm	70	11400	12280	12280	11400
	T35-2B-150	150cm	87,5	14250	15350	15350	14250
	T35-2B-180	180cm	105	17100	18420	18420	17100
	T35-2B-210	210cm	122,5	19950	21490	21490	19950
	T35-2B-240	240cm	140	22800	24560	24560	22800
	T35-2B-270	270cm	157,5	25650	27630	27630	25650
	T35-2B-300	300cm	175	28500	30700	30700	28500
	T35-2B-330	330cm	192,5	31350	33770	33770	31350
	T35-2B-360	360cm	210	34200	36840	36840	34200
	T35-2B-390	390cm	227,5	37050	39910	39910	37050
	T35-2B-420	420cm	245	39900	42980	42980	39900
	T35-2B-450	450cm	262,5	42750	46050	46050	42750
	T35-2B-480	480cm	280	45600	49120	49120	45600

T35 - XX - XXX - X - XX - X - X

(a) Κωδικός Γραμμικού Linear Code
 (b) Κατηγορία Category
 (c) Μήκος Length
 (d) Θερμοκρασία φωτός Color Temperature
 (e) Κάλυμμα Cover
 (f) Αυξομείωση έντασης φωτός Dimming
 (g) Χωνευτή τοποθέτηση Trimless installation

Παράδειγμα κωδικού / Code example

GILA 35x35 TRIMLESS 1A 90cm 3000K Diffuser 1,5m Dimmable with Plastic Angular
 SKU: T35-1A-90-3-C2-D-P

ΤΟΠΟΘΕΤΗΣΗ ΜΕ ΓΩΝΙΟΚΡΑΝΟ ΑΛΟΥΜΙΝΙΟΥ / APPLICATION WITH ALUMINIUM ANGULAR

1. Κόβετε τη γυψοσανίδα στις αναγραφόμενες διαστάσεις κοπής
Cut the plasterboard according to the cut-out dimensions.

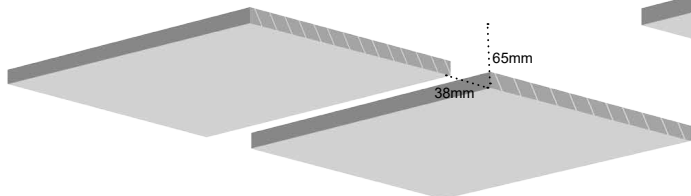

2. Συνδέστε το προφίλ με την παροχή ηλεκτρισμού.
Connect the luminaire with the power supply.

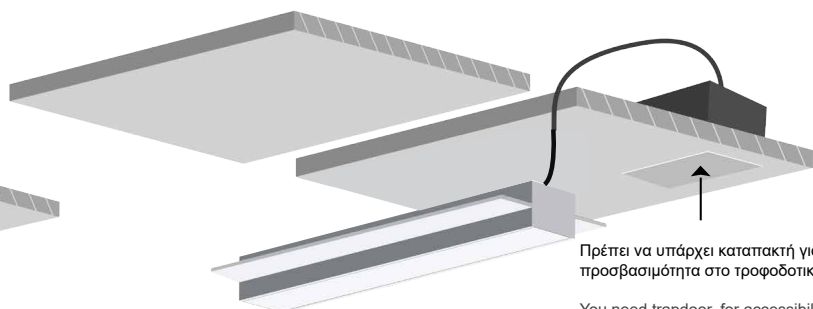

3. Περιστρέψτε το φωτιστικό έτσι ώστε να χωράει μέσα από την οπή στην επιφάνεια.
Rotate the luminaire in order to pass it through the hole on the surface.

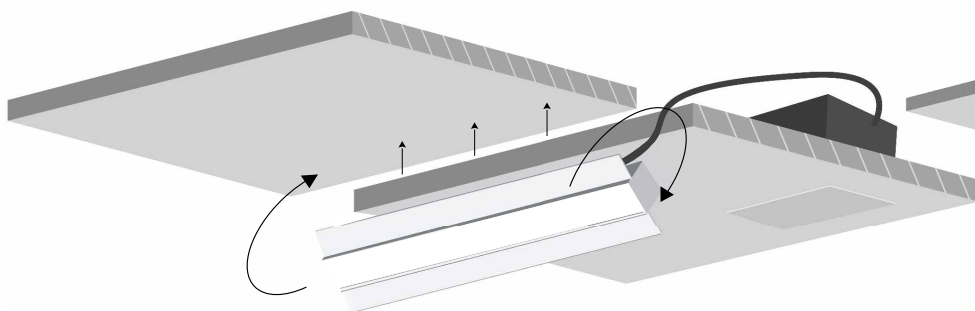

4. Αφού περάσετε το φωτιστικό μέσα από την οπή, βρείτε την κατάλληλη θέση και σταθεροποιήστε το βιδώνοντάς το στο ταβάνι.
Pass the luminaire through the hole and after finding the right installation, you stabilize it by screwing it to the ceiling.

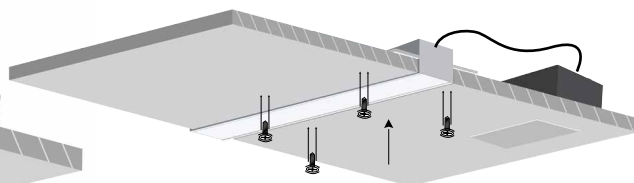

5. Καλύψτε τις βίδες απλώνοντας επίχρισμα στην επιφάνεια.
Cover the screws applying roughcast on the surface.

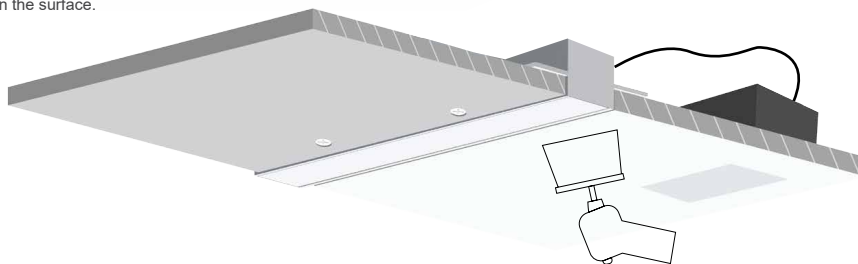

6. Το φωτιστικό είναι έτοιμο για χρήση.
The luminaire is ready for use.

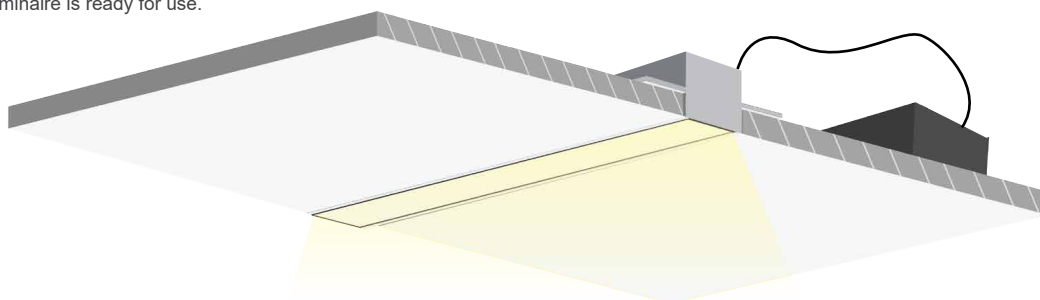

ΤΟΠΟΘΕΤΗΣΗ ΜΕ ΠΛΑΣΤΙΚΟ ΓΩΝΙΟΚΡΑΝΟ / APPLICATION WITH PLASTIC ANGULAR

1. Κόβετε τη γυψοσανίδα στις αναγραφόμενες διαστάσεις κοπής
Cut the plasterboard according to the cut-out dimensions.

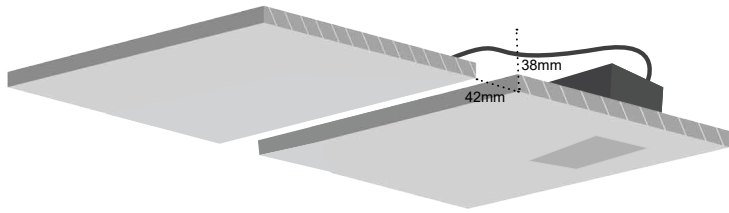

2. Συνδέστε το φωτιστικό με την παροχή ηλεκτρισμού και εφαρμόστε το στην οροφή.
Connect the luminaire with the power supply and screw it to the ceiling.

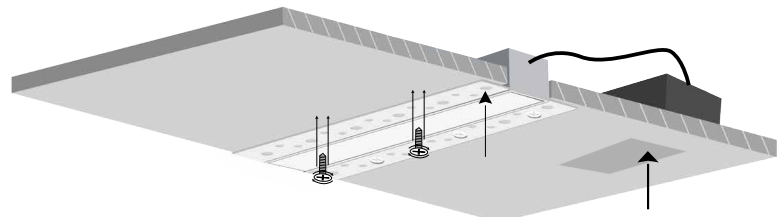

Πρέπει να υπάρχει καταπακτή για προσβασιμότητα στο τροφοδοτικό.
You need trapdoor, for accessibility to the power supply.

3. Καλύψτε τις βίδες απλώνοντας επίχρισμα στην επιφάνεια.
Cover the screws by applying roughcast on the surface.

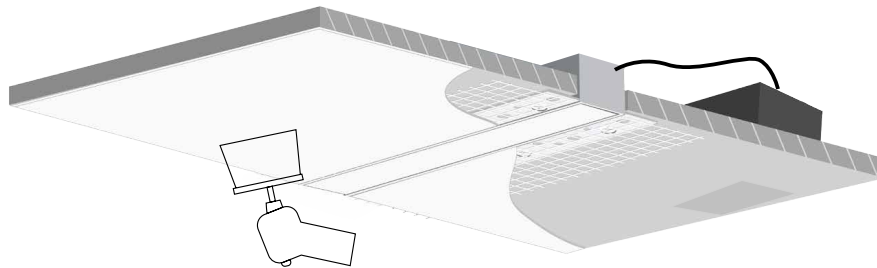

4. Το φωτιστικό είναι έτοιμο για χρήση.
The luminaire is ready for use.

The luminaire is ready for use.

