

TUBE R60×80

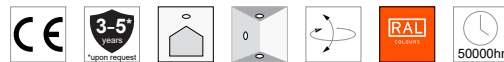

ΠΕΡΙΕΧΟΜΕΝΑ / CONTENTS

Datasheet	1
Manual	4

SKU: TUBER60- XX-XX-XX-XX-XX-XX-XX-XX-XX-XX-XX-XX

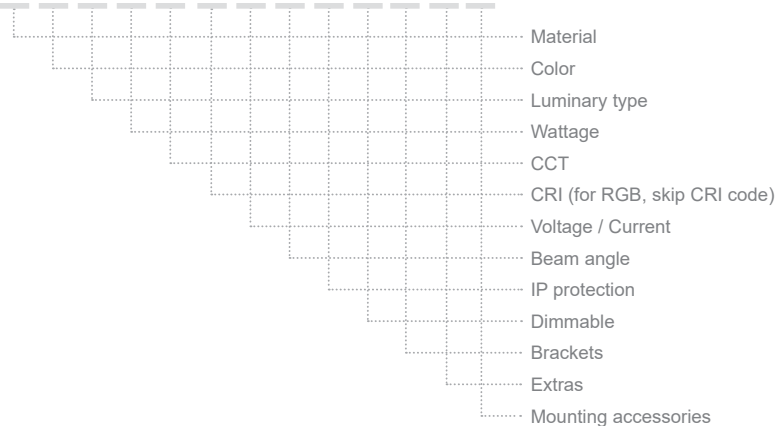

DATASHEET

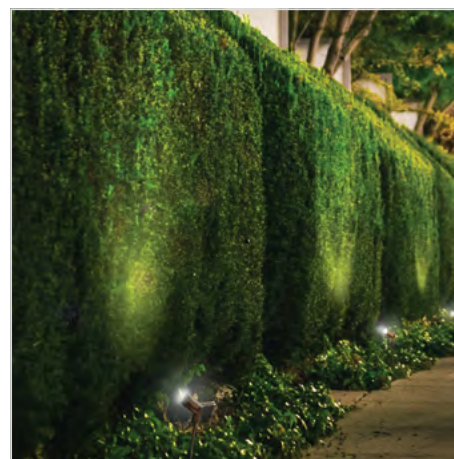
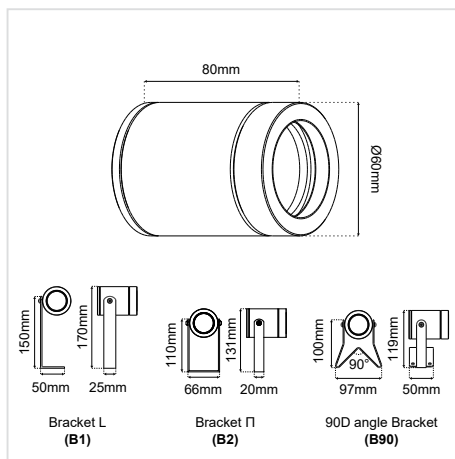

GENERAL INFORMATION

APPLICATION	Outdoor / Surface mounted
DIRECTION OF MOUNTING	Ceiling / Wall / Ground
INCL. CABLE	Yes
LED TYPE	XTE/XRE/XPE/NICHIA/GU10
LIFE TIME	50000 hours
WARRANTY	3–5 years (*5 years upon request)
ORIGIN	Greece
VISIBLE DIMENSIONS (Ø×L)	Ø60 × 80 mm

TUBE R60×80 / Datasheet

SKU: TUBER60- XX-XX-XX-XX-XX-XX-XX-XX-XX-XX-XX-XX-XX-XX

MATERIAL
COLOR
LUMINARY TYPE
WATTAGE
CCT
CRI (skip for RGB)
VOLTAGE
BEAM ANGLE
IP PROTECTION
DIMMABLE
BRACKETS
EXTRAS
MOUNTING ACCESSORIES

Material*	Color*	Luminary type*	WATTAGE*		
Aluminium (01)	Anodised (AN)	GU10 (230VAC) (GU1) *	3W (3W)	6W (6W)	9W (9W)
Inox (02)	Black (BL)	GU5.3 (12AC/DC) (GU5) *	4W (4W)	7W (7W)	10W (10W)
Brass (03)	White (WH)	LED (1L)	5W (5W)	8W (8W)	15W (15W)
	Graphite (GF)				
	RAL colors (RL)				
	Patina (PT)				

* Wattage, CCT, CRI, Voltage, Beam angle and Dimmable options are not available for GU10 and GU5.3

Please find the remaining options below, in the section that corresponds on your selection of wattage.













W	CCT*						CRI*		Voltage*					Beam angle*									
3W	2700K (27K)	3000K (30K)	4000K (40K)	5000K (50K)	6000K (60K)	(R) / (G) / (B) / (A)	RGB (C1)	Ra80 (80)	Ra90 (90)	12VDC (V1)	24VDC (V2)	12/24V (V4)	350mA (V5)	500mA (V6)	Diffuse (DF)	3D (3D)	8D (8D)	15D (15D)	20D (20D)	35D (35D)	45D (45D)	60D (60D)	80D (80D)
										230VAC (V3)													
4W	2700K (27K)	3000K (30K)	4000K (40K)	5000K (50K)	6000K (60K)	(R) / (G) / (B) / (A)	RGB (C1)	Ra80 (80)	Ra90 (90)	12VDC (V1)	24VDC (V2)	12/24V (V4)	350mA (V5)	500mA (V6)	Diffuse (DF)	8D (8D)	15D (15D)	20D (20D)	35D (35D)	45D (45D)	60D (60D)	80D (80D)	
										230VAC (V3)													
5W	2700K (27K)	3000K (30K)	4000K (40K)	5000K (50K)	6000K (60K)	(R) / (G) / (B) / (A)	RGB (C1)	Ra80 (80)	Ra90 (90)	12VDC (V1)	24VDC (V2)	12/24V (V4)	350mA (V5)	500mA (V6)	Diffuse (DF)	3D (3D)	8D (8D)	15D (15D)	20D (20D)	35D (35D)	45D (45D)	60D (60D)	80D (80D)
										230VAC (V3)													
6W	2700K (27K)	3000K (30K)	4000K (40K)	5000K (50K)	6000K (60K)	(R) / (G) / (B) / (A)	RGB (C1)	Ra80 (80)	Ra90 (90)	12VDC (V1)	24VDC (V2)	12/24V (V4)	350mA (V5)	500mA (V6)	Diffuse (DF)	8D (8D)	15D (15D)	20D (20D)	35D (35D)	45D (45D)	60D (60D)	80D (80D)	
										230VAC (V3)													
7W	2700K (27K)	3000K (30K)	4000K (40K)	5000K (50K)	6000K (60K)	(R) / (G) / (B) / (A)	RGB (C1)	Ra80 (80)	Ra90 (90)	12VDC (V1)	24VDC (V2)	12/24V (V4)	350mA (V5)	500mA (V6)	Diffuse (DF)	8D (8D)	15D (15D)	20D (20D)	35D (35D)	45D (45D)	60D (60D)	80D (80D)	
										230VAC (V3)													
8W	2700K (27K)	3000K (30K)	4000K (40K)	5000K (50K)	6000K (60K)	(R) / (G) / (B) / (A)	RGBW (C2)	Ra80 (80)	Ra90 (90)	24VDC (V2)	350mA (V5)	500mA (V6)	Diffuse (DF)	9D (9D)	25D (25D)	35D (35D)	45D (45D)	50-24D (5024D)	15-45D (1545D)	16-60D (1660D)			
										230VAC (V3)				20D (20D)	45D (45D)								
9W	2700K (27K)	3000K (30K)	4000K (40K)	5000K (50K)	6000K (60K)	(R) / (G) / (B) / (A)	RGBW (C2)	Ra80 (80)	Ra90 (90)	12VDC (V1)	24VDC (V2)	12/24V (V4)	350mA (V5)	500mA (V6)	Diffuse (DF)	20D (20D)	45D (45D)						
										230VAC (V3)													
10W	2700K (27K)	3000K (30K)	4000K (40K)	5000K (50K)	6000K (60K)	(R) / (G) / (B) / (A)	RGBW (C2)	Ra80 (80)	Ra90 (90)	24VDC (V2)	350mA (V5)	500mA (V6)	Diffuse (DF)	9D (9D)	25D (25D)	35D (35D)	45D (45D)	50-24D (5024D)	15-45D (1545D)	16-60D (1660D)			
										230VAC (V3)				20D (20D)	45D (45D)								
15W	2700K (27K)	3000K (30K)	4000K (40K)	5000K (50K)	6000K (60K)			Ra80 (80)	Ra90 (90)	230VAC (V3)				Diffuse (DF)	20D (20D)	45D (45D)							

TUBE R60×80 / Datasheet

SKU: TUBER60- XX-XX-XX-XX-XX-XX-XX-XX-XX-XX-XX-XX

MATERIAL
 COLOR
 LUMINARY TYPE
 WATTAGE
 CCT
 CRI (skip for RGB)
 VOLTAGE
 BEAM ANGLE
 IP PROTECTION
 DIMMABLE
 BRACKETS
 EXTRAS
 MOUNTING ACCESSORIES

EXTRAS OPTIONS:

IP protection*	Dimmable*	Brackets*	Extras	Mounting accessories
IP65 (65)	Dim (D)	Bracket L (B1) 	Honeycomb (HC) 	Pole Φ10×200mm Brass (PL1) 
IP67 (67)	No Dim (L)	Bracket Π (B2) 	Shadow Aluminium (SH01) 	Pole Φ10×600mm Brass (PL2) 
		90D angle Bracket (B90) 	Shadow Inox (SH02) 	Pole Φ10×1000mm Brass (PL3) 
			Shadow Brass (SH03) 	Spike D32×150mm Aluminium (SP) 
				Hinged Rod with Base (HRB) 
				Base Bracket Π H106mm (BB4) 

Δημιουργία Κωδικού προϊόντος / Product Code generator

TUBER60- material - color - luminary type - wattage - CCT - CRI - voltage - beam angle - IP - dimmable - brackets - extras - mounting accessories

EXAMPLE:

TUBER60 - 01-BL-1L-3W-27K-90-V1-15D-65-D-SH01-HC -PL1

for TUBE R60×80, aluminium, black, 3W, 2700K, Ra90, 12VDC, 15o, IP65, dimmable, Bracket L, aluminium shadow and honeycomb - Pole Φ10x200mm Brass

TUBE R60×80 MANUAL

ΟΔΗΓΙΕΣ ΕΓΚΑΤΑΣΤΑΣΗΣ INSTALLATION INSTRUCTIONS

ΣΗΜΑΝΤΙΚΟ:

Αυτό το εξάρτημα πρέπει να εγκατασταθεί από εξειδικευμένο ηλεκτρολόγο.

Η BarisLight δεν φέρει ευθύνη για τυχόν ζητήματα που προκύπτουν από ακατάλληλη εγκατάσταση που δεν συμμορφώνεται με τα τοπικά πρότυπα ασφαλείας.

Παρακαλούμε δώστε ένα αντίγραφο αυτών των οδηγιών στο άτομο που είναι υπεύθυνο για τη συντήρηση της εγκατάστασης.

IMPORTANT:

This luminaire must be installed by a qualified electrician.

Disclaimer:

BarisLight is not liable for any issues arising from improper installation that does not comply with local safety standards.

Instructions:

Please provide a copy of these instructions to the person responsible for maintaining the installation.

Εφαρμογή στην επιφάνεια, με βραχίονα τύπου L (B1) Application on the surface, with braket L (B1)

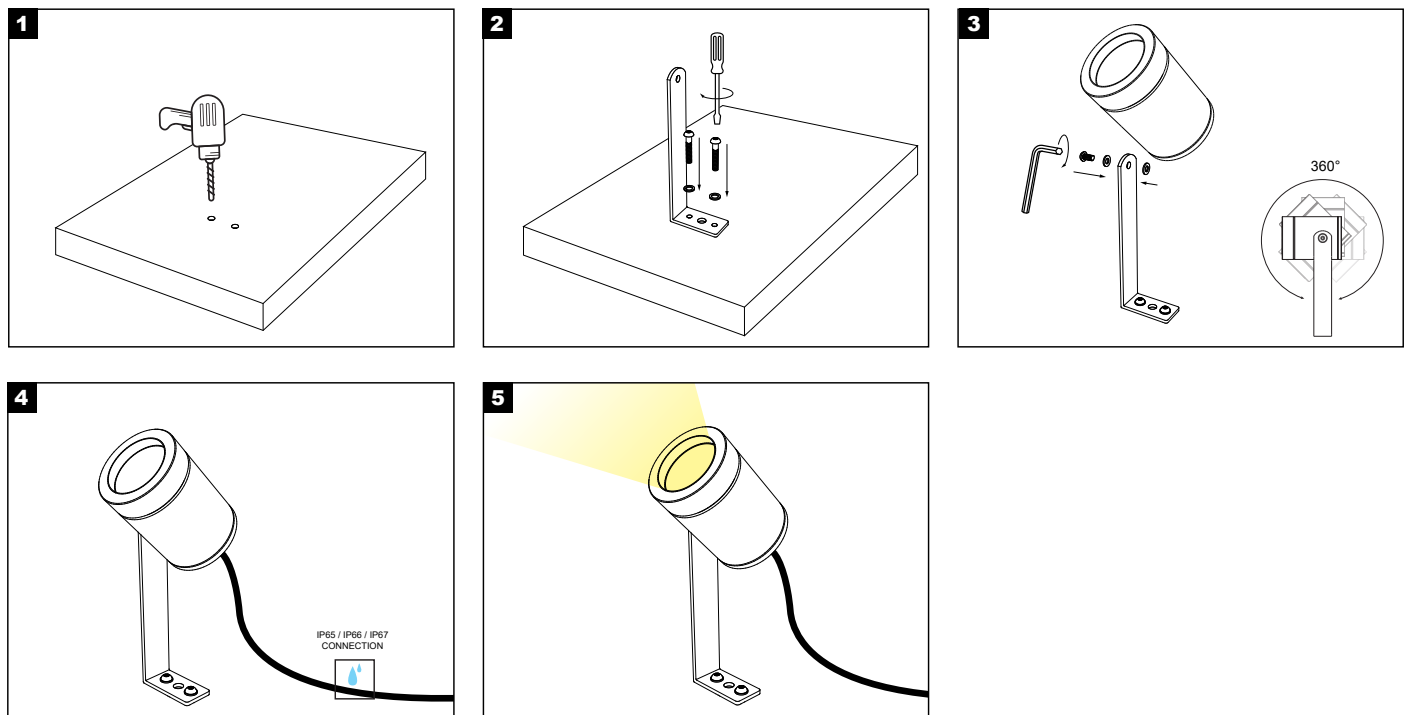

TUBE R60×80 MANUAL

Εφαρμογή στην επιφάνεια, με βραχίονα τύπου Π (B2) Application on the surface, with bracket Π (B2)

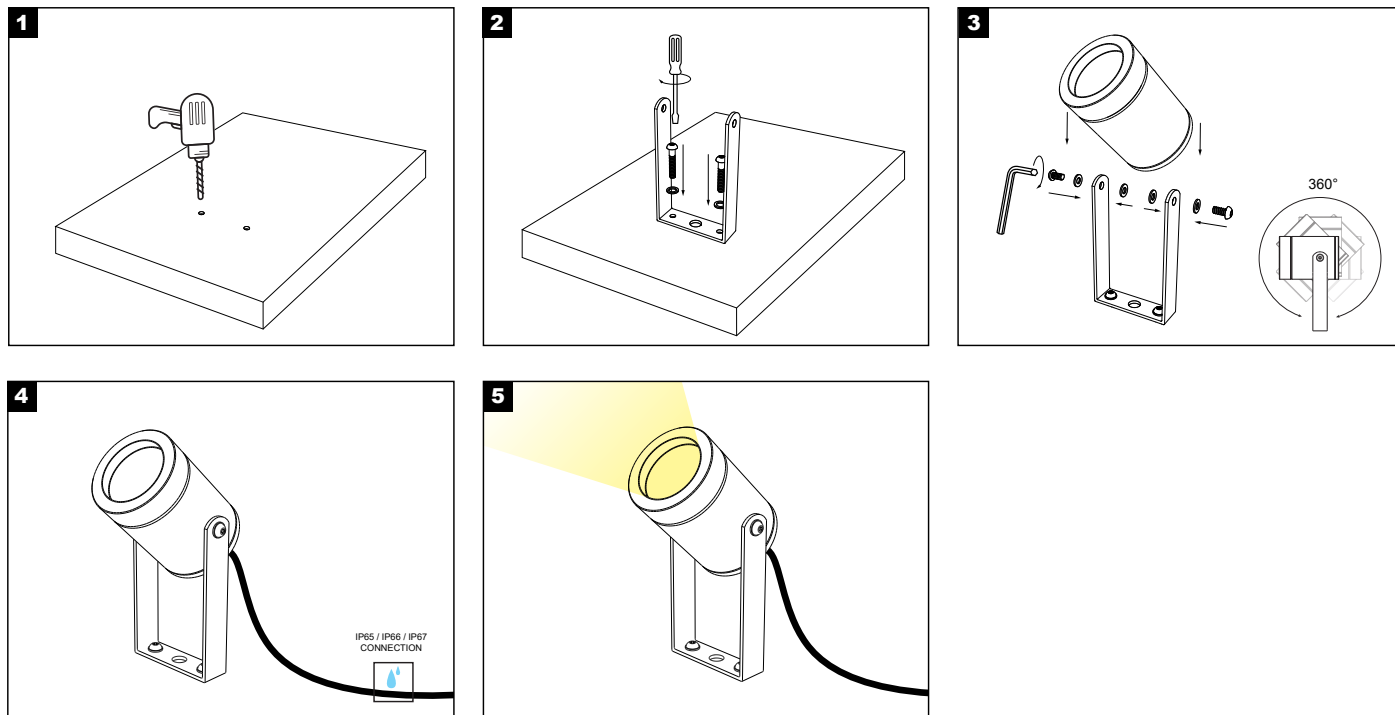

Εφαρμογή στην επιφάνεια, με βραχίονα γωνίας 90° (B90) Application on the surface, 90° angle bracket (B90)

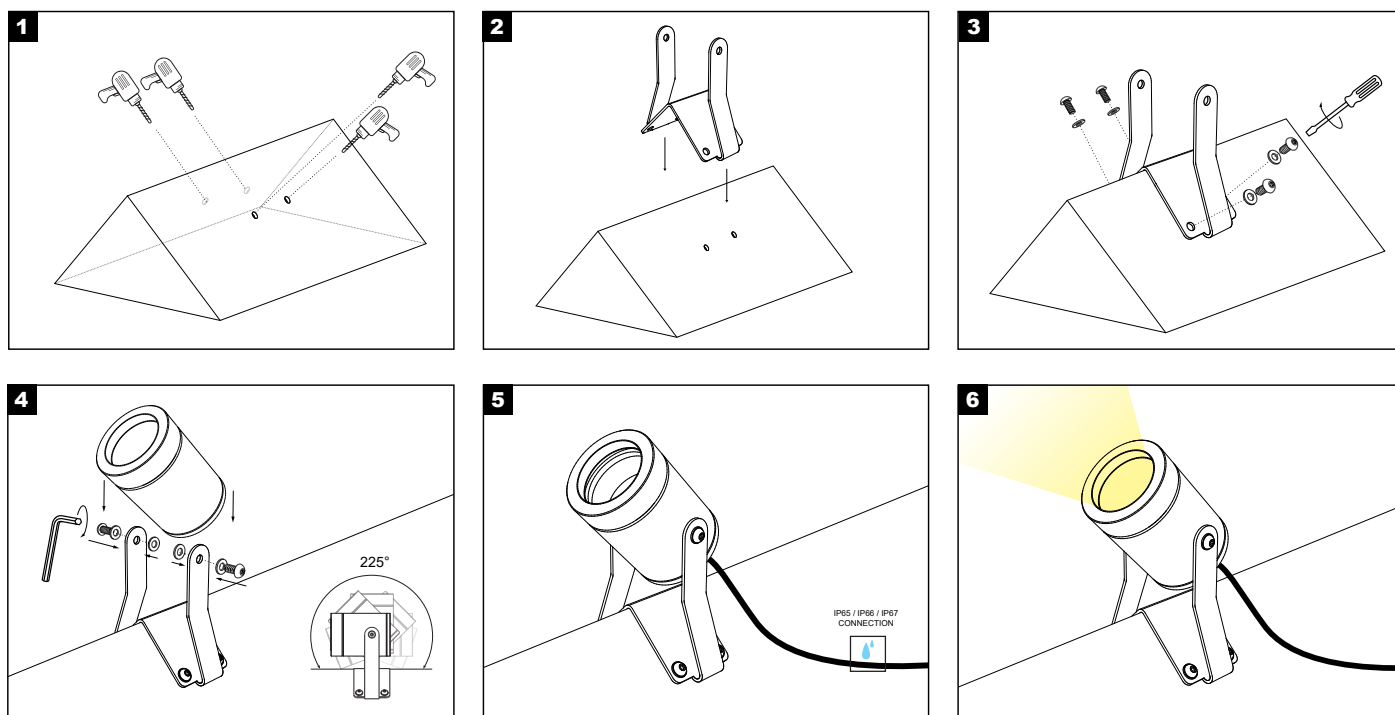

Η εγκατάσταση του προϊόντος πρέπει να γίνεται από αδειούχο ηλεκτρολόγο εγκαταστάτη. The product must be installed by a licensed electrical installer.

TUBE R60×80 MANUAL

Σύνδεση με την ηλεκτρική παροχή Connection to the electrical supply

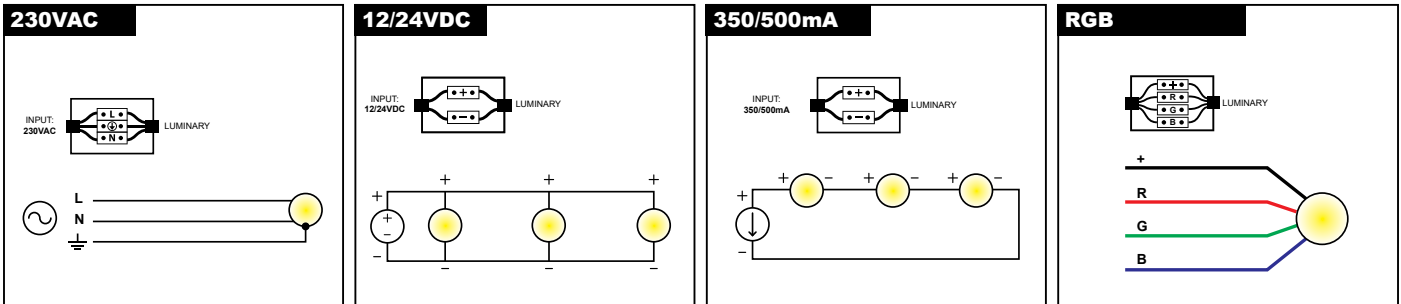

Διαδικασία καλωδίωσης

1. Κλείστε τον κεντρικό διακόπτη ρεύματος.
2. Συνδέστε τα φωτιστικά στη μονάδα παροχής ρεύματος.
3. Συνδέστε τη μονάδα τροφοδοσίας στο ηλεκτρικό δίκτυο.
4. Ενεργοποιήστε τον κεντρικό διακόπτη ρεύματος.

Σημείωση ασφαλείας: Βεβαιωθείτε ότι ο κεντρικός διακόπτης λειτουργίας είναι απενεργοποιημένος κατά τη διάρκεια όλων των διαδικασιών συντήρησης και εγκατάστασης.

Προειδοποίηση: Αποφύγετε τη σύνδεση πάρα πολλών φωτιστικών παράλληλα σε μία μόνο μονάδα τροφοδοσίας για να αποφευχθεί η υπερφόρτωση.

Wiring Procedure

1. Turn off the main power switch.
2. Connect the luminaires to the power supply unit.
3. Connect the power supply unit to the electrical network.
4. Turn on the main power switch.

Safety Notice: Ensure the main power switch is turned off during all maintenance and installation procedures.

Warning: Avoid connecting too many luminaires in parallel to a single power supply unit to prevent overloading.

TUBE R60×80 MANUAL

Εναλλακτικοί τρόποι τοποθέτησης Alternative application methods

Spike D32x150mm Aluminium (SP)

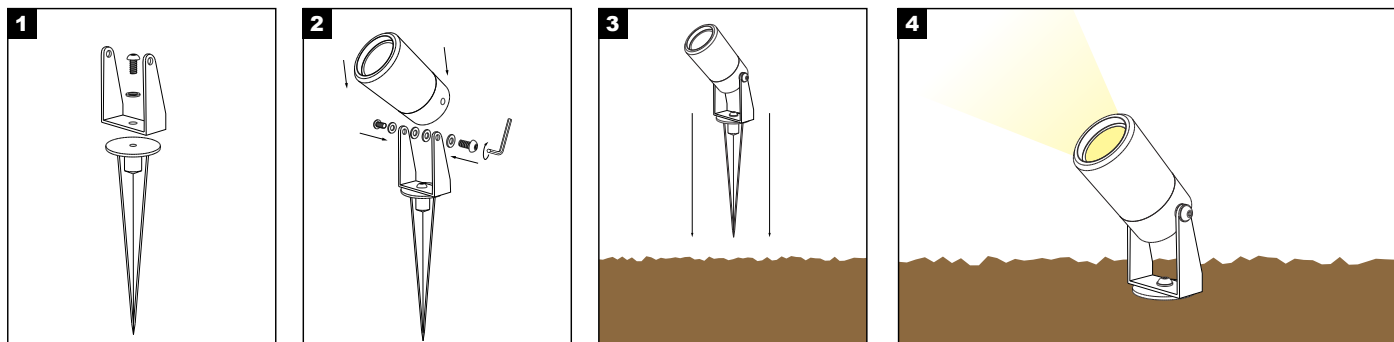

Pole D10×200-1000mm Brass (PL1/ PL2/ PL3)

