

LINEAR IN 53×70 20W/m



ΠΕΡΙΕΧΟΜΕΝΑ / CONTENTS

DATASHEET 1
 MANUAL 3

SKU: **IN537A**XX-XX-XX-XX-XX-XX-XX

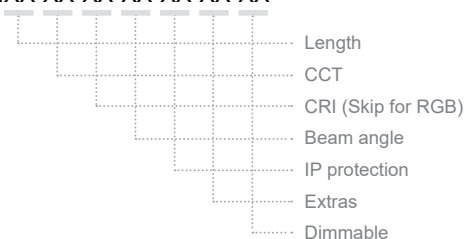

DATASHEET

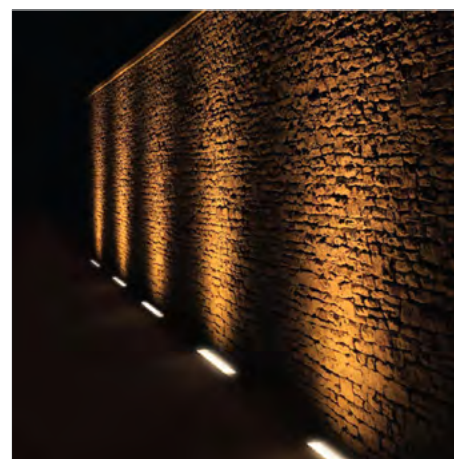
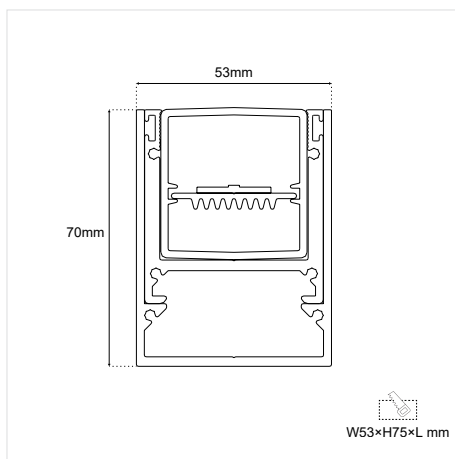











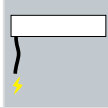



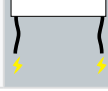

GENERAL INFORMATION

APPLICATION	Outdoor / Recessed
DIRECTION OF MOUNTING	Ground
MATERIAL	Aluminium, polycarbonate
COVER MATERIAL	Polycarbonate
VISIBLE DIMENSIONS (W×H)	53 × 70 mm
CUT-OUT DIMENSIONS (W×H)	53 × 75 mm
INCL. CABLE	Yes
IK CLASSIFICATION	IK10
LEDS' COLOR	White & Color
VOLTAGE	24VDC
WATTAGE	20 W/m
OUTPUT	90 lm/W
LIFE TIME	30000 hours
WARRANTY	3–5 years (*5 years upon request)
ORIGIN	Greece

LINEAR IN 53×70 20W/m DATASHEET

SKU: IN537A- XX-XX-XX-XX-XX-XX-XX-XX

LENGTH
CABLE CONFIGURATION
CCT
CRI (skip for RGB)
BEAM ANGLE
IP PROTECTION
EXTRAS
DIMMABLE

Length*	Cable Configuration*	CCT*	CRI*	Beam Angle*
20cm (20)	Input Only (Single Cable on One End) (IO1) 	2200K (22K) 	Ra80 (80)	Diffuse (DF) 
30cm (30)		2700K (27K) 	Ra90 (90)	8D (8D) 
60cm (60)	Input-Output (Dual Cables on Opposite Ends) (IO2)  <p>Προσοχή: Το συνολικό επιτρεπόμενο φορτίο των συνδεδεμένων φωτιστικών δεν πρέπει να υπερβαίνει τα 200W, για την αποφυγή υπερθέρμανσης ή ζημιάς.</p> <p>Warning: The total wattage of connected fixtures must not exceed 200W to prevent overheating or damage.</p>	3000K (30K) 		18D (18D) 
90cm (90)		4000K (40K) 		25D (25D) 
120cm (120)		6000K (60K) 		30D (30D) 
150cm (150)		(R) / (G) / (B) / (A) 		10×55D (1055D) 
180cm (180)				10×100D (10110D) 
210cm (210)				15×45D (1545D) 
240cm (240)				Asymmetrical (ASYM) 
270cm (270)				
300cm (300)				

IP*	Extras	Dimmable*
IP20 (20)	Honeycomb (HC) 	Dim (D)
IP65 (65)		No Dim (␣)
IP67 (67)		
IP68 (68)		

Για περισσότερα μήκη κοπής και ειδικές κατασκευές, επικοινωνήστε με την ομάδα της BarisLight.

For more cutting lengths and custom designs, contact BarisLight team.

* Υποχρεωτική επιλογή / Mandatory option

Δημιουργία Κωδικού προϊόντος / Product Code generator

IN537A- length - cable configuration CCT - CRI - beam angle - IP - extras - dimmable

EXAMPLE:

IN537A - 60-IO1-27K-90-8D-65-HC-D

for LINEAR IN 53×70 20W/m, 60cm, Single cable, 2700K, Ra90, 8D, IP65, honeycomb, dimmable

LINEAR IN 53×70 20W/m MANUAL

ΟΔΗΓΙΕΣ ΕΓΚΑΤΑΣΤΑΣΗΣ INSTALLATION INSTRUCTIONS

ΣΗΜΑΝΤΙΚΟ:

Αυτό το εξάρτημα πρέπει να εγκατασταθεί από εξειδικευμένο ηλεκτρολόγο.

Η BarisLight δεν φέρει ευθύνη για τυχόν ζητήματα που προκύπτουν από ακατάλληλη εγκατάσταση που δεν συμμορφώνεται με τα τοπικά πρότυπα ασφαλείας.

Παρακαλούμε δώστε ένα αντίγραφο αυτών των οδηγιών στο άτομο που είναι υπεύθυνο για τη συντήρηση της εγκατάστασης.

IMPORTANT:

This luminaire must be installed by a qualified electrician.

Disclaimer:

BarisLight is not liable for any issues arising from improper installation that does not comply with local safety standards.

Instructions:

Please provide a copy of these instructions to the person responsible for maintaining the installation.

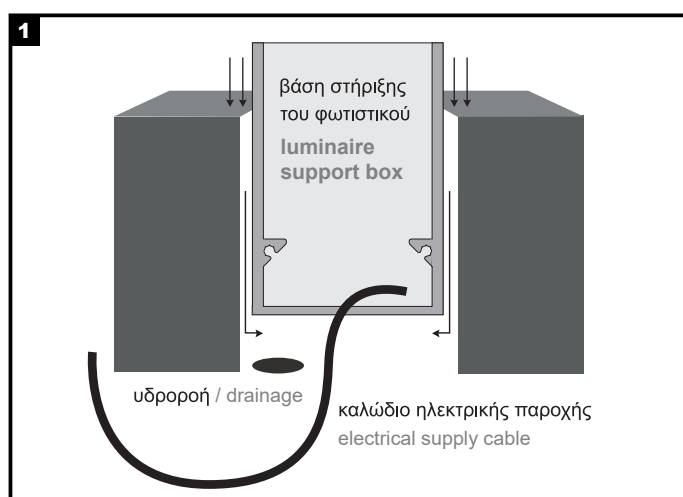

Διαδικασία καλωδίωσης

1. Κλείστε τον κεντρικό διακόπτη ρεύματος.
2. Συνδέστε τα φωτιστικά στη μονάδα παροχής ρεύματος.
3. Συνδέστε τη μονάδα τροφοδοσίας στο ηλεκτρικό δίκτυο.
4. Ενεργοποιήστε τον κεντρικό διακόπτη ρεύματος.

Σημείωση ασφαλείας: Βεβαιωθείτε ότι ο κεντρικός διακόπτης λειτουργίας είναι απενεργοποιημένος κατά τη διάρκεια όλων των διαδικασιών συντήρησης και εγκατάστασης.

Προειδοποίηση: Αποφύγετε τη σύνδεση πάρα πολλών φωτιστικών παράλληλα σε μία μόνο μονάδα τροφοδοσίας για να αποφευχθεί η υπερφόρτωση.

2 Σύνδεση με την ηλεκτρική παροχή Connection to the electrical supply

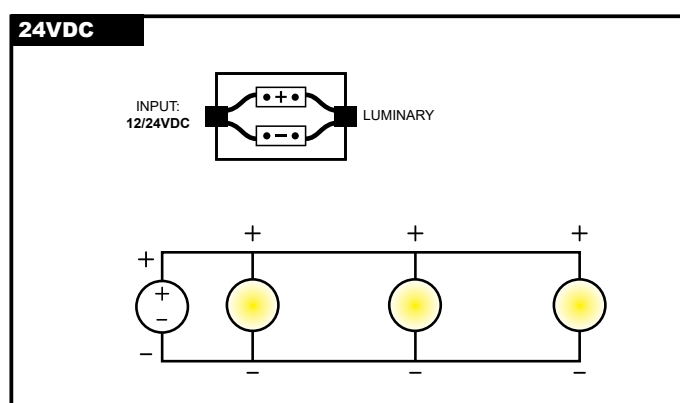

Wiring Procedure

1. Turn off the main power switch.
2. Connect the luminaires to the power supply unit.
3. Connect the power supply unit to the electrical network.
4. Turn on the main power switch.

Safety Notice: Ensure the main power switch is turned off during all maintenance and installation procedures.

Warning: Avoid connecting too many luminaires in parallel to a single power supply unit to prevent overloading.

LINEAR IN 53×70 20W/m MANUAL

