

LED NEON STRIP D22mm 360° IP67

SKU: ● 2700K: E9010805-071, ● 3000K: E9010805-024, ● 4000K: E9010805-028, ● 6000K: E9010805-029, ● RGB: E9010805-030

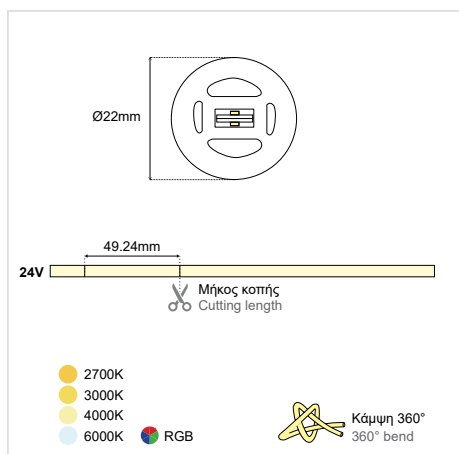
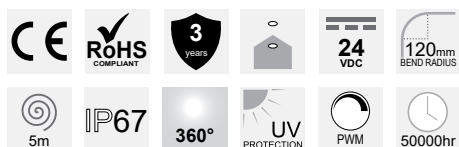

GENERAL INFORMATION

APPLICATION:	Indoor / Outdoor
MATERIAL:	Silicone
COLOR:	White
IP PROTECTION:	IP67
WORKING ENVIROMENT TEMPERATURE:	-40°C – +60°C
UV-PROTECTION:	Anti-UV
CABLE INCLUDED:	Yes
DRIVER INCLUDED:	No
LIFETIME:	50000 hours
WARRANTY:	3 years
ORIGIN:	PRC











PHYSICAL INFORMATION

DIMENSIONS:	Ø22mm
MAXIMUM LENGTH:	5m
CUTTING LENGTH:	49.24mm
WEIGHT:	1.9kg/reel

ILLUMINANT

LED TYPE:	2835 SMD
STRIP LIGHT QTY:	2 pcs
PCB:	CCT: 5mm width, 2oz RGB: 8mm width, 2oz
LED QTY:	240 LEDs/m
VOLTAGE:	24VAC
BEAM ANGLE:	360D
DIMMABLE:	PWM

LED NEON STRIP D22mm 360° IP67

Available colors			LED Strip (Source) Lumen Efficiency	Neon Light (Delivered) Lumen Efficiency	SKU	
2700K			16W/m	111 lm/W	48lm/W	E9010805-071
3000K				111 lm/W	53 lm/W	E9010805-024
4000K				121 lm/W	58 lm/W	E9010805-028
6000K				92 lm/W	44 lm/W	E9010805-029
RGB			24W/m			E9010805-030

TO BE USED WITH



Clip
SKU: E9010803-036



Metal End Cap
SKU: Black: E9010803-033
 White: E9010803-034



End Cap
SKU: E9010803-019



Suspension 1m Kit 1pc
SKU: 00010803-050



Installation Box
SKU: Black: 3D010205-042
 White: 3D010205-041

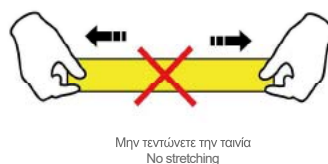
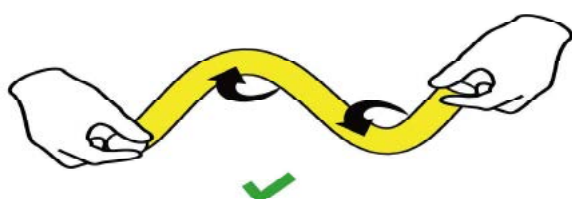

LED NEON STRIP D22mm 360° IP67

CONNECTION DIAGRAM

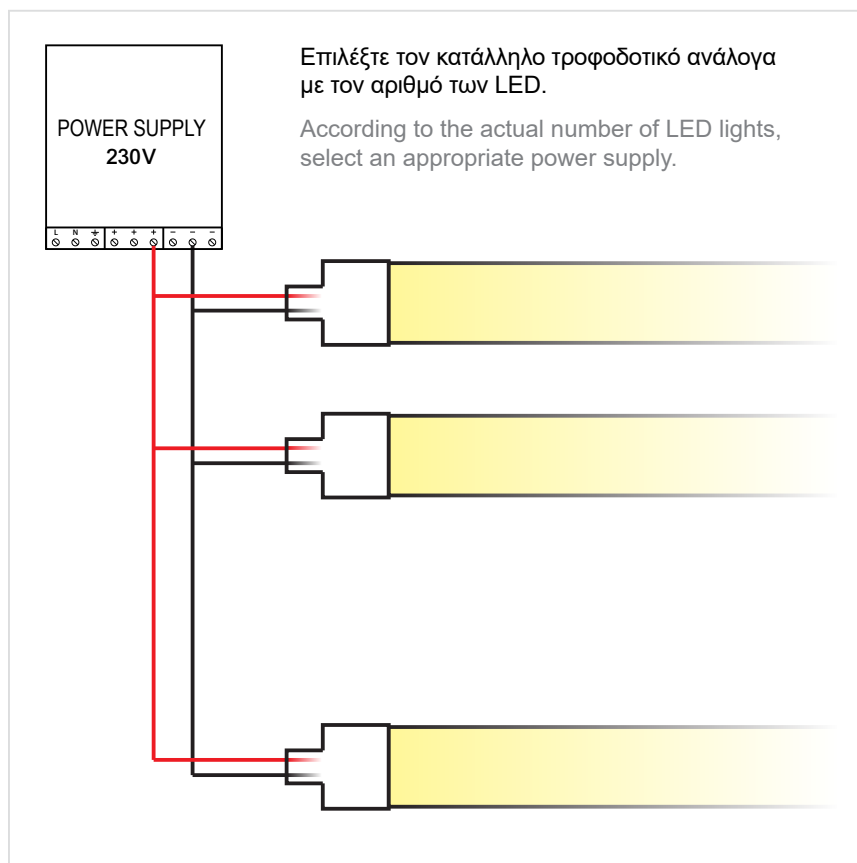

ΣΗΜΑΝΤΙΚΟ:

Αυτό το εξάρτημα πρέπει να εγκατασταθεί από εξειδικευμένο ηλεκτρολόγο.

Η BarisLight δεν φέρει ευθύνη για τυχόν ζητήματα που προκύπτουν από ακατάλληλη εγκατάσταση που δεν συμμορφώνεται με τα τοπικά πρότυπα ασφαλείας.

ΠΡΟΦΥΛΑΞΕΙΣ:

1. Διαβάστε προσεκτικά τις προδιαγραφές πριν χρησιμοποιήσετε το προϊόν.
2. Βεβαιωθείτε ότι το τροφοδοτικό είναι DC 24V.
3. Απαγορεύεται αυστηρά η εργασία σε γραμμές υπό τάση.
4. Μην χρησιμοποιείτε όξιμες ή αλκαλικές κόλλες σε επαφή με το προϊόν.
5. Αποφύγετε να ασκείτε πίεση ή δύναμη στην επιφάνεια των LED.
6. Η εγκατάσταση, επισκευή και συντήρηση πρέπει να γίνεται μόνο από επαγγελματίες.
7. Ελέγξτε όλες τις συνδέσεις πριν την ενεργοποίηση για αποφυγή σφαλμάτων.

IMPORTANT:

This luminaire must be installed by a qualified electrician.

Disclaimer:

BarisLight is not liable for any issues arising from improper installation that does not comply with local safety standards.

PRECAUTIONS:

1. Carefully read the specifications before using the product.
2. Ensure the power supply is 24V DC.
3. Avoid working on live wires under any circumstances.
4. Do not use acidic or alkaline adhesive glues in contact with this product.
5. Avoid pressing or applying excessive force to the LED surface.
6. Installation, repair, and maintenance must be performed by professionals only.
7. Double-check all connections before powering on to prevent errors.