

liniLED®

# Manual

## liniLED® Dim 4-DALI-PRO

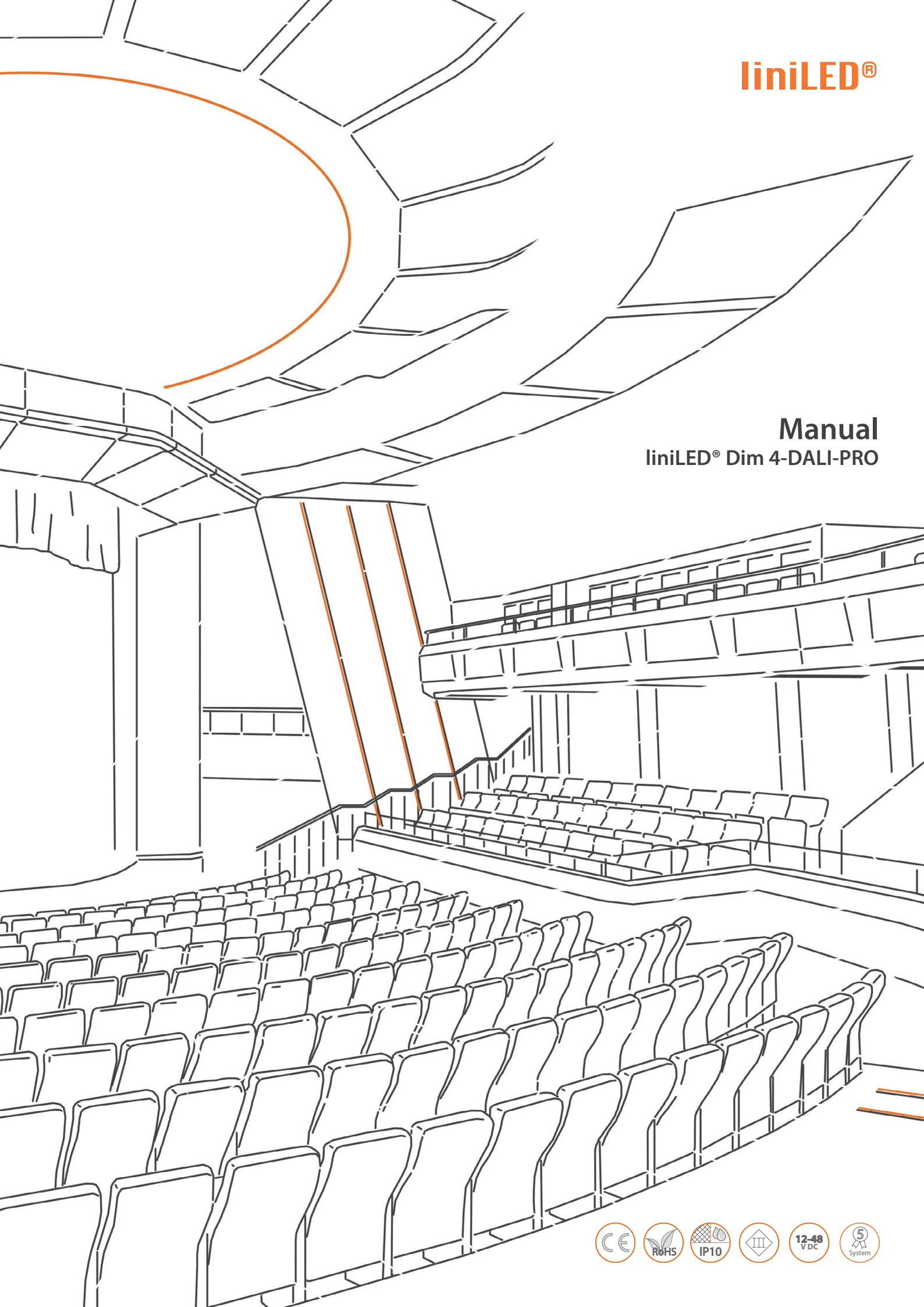



# liniLED®

---

## Dim 4-DALI-PRO

Technical notes	4
Product drawing	5
Technical specifications	5
Protection circuits	6
Reference standards	6
Configuration setup	7
<i>Step 1: Opening the driver</i>	7
<i>Step 2: Load type and parallel output</i>	8
<i>Step 3: Mapping</i>	10
<i>Step 4: Dimming curve</i>	11
<i>Step 5: Control input type</i>	11
<i>Step 6: DALI BUS setup</i>	12
<i>Step 7: Analogue control input</i>	12
<i>Step 8: Output frequency</i>	13
<i>Step 9: Closing the driver</i>	13
Control input functionalities	14
Operation functions	16
<i>N.O. pushbutton</i>	16
<i>0/1-10 V and potentiometers</i>	17
DALI channels map	18
DALI commands	21
Symbols	22

## Technical notes

---

*Read the instructions and safety precautions before installation, usage and storage of the products to secure safety of the user and reliability of the product.*

- Hand over the instructions to the end-user and those responsible for installation and usage.
- Triolight B.V. cannot be held responsible for improper handling, product installation, usage or storage.

### Handling

- The product may not be modified or converted otherwise than described in this manual.
- Products are to be transported in proper packaging. Products should remain packed until installation.
- Take ESD (Electro Static Discharge) protection measures when handling liniLED® products.
- The products and their components may not be exposed to mechanical, static loads and other tension/compression other than from the product itself.

### Installation

- Attention: the main power has to be switched off before installation. Not doing so may damage the product or cause injury.
- Installation has to be done by a professional with knowledge of electrical circuits or a certificated maintenance person known with valid directives.
- General and local construction-, safety- and installation regulations must be followed.
- Use only supplied parts, accessories and required tools as prescribed in the installation manual to guarantee a safe installation and use of the product.
- Products may solely be installed in the areas according to their prescribed IP-rating, IK-rating, temperature range and chemical resistances.
- The product must be installed inside an electrical housing protected against overvoltages.
- The product must be installed in a vertical or horizontal position with the cover/ label upwards or vertically; other positions are not permitted.
- It is not permitted to bottom-up position (with the cover/label down).
- Do not install the product in the following cases:
  - Damage is visible on the product or its cables
  - The inside of the product is moistened or dirty
  - The product or its cables have been modified. It could lead to an electrical shock or a short circuit may occur.

### Cables

- All cables used in the setup must be dimensioned properly and should be isolated from any other wiring or electronic conductive parts. It is suggested to use double insulated and if applicable shielded and twisted cables.
- The length of the connecting cables between the product and the LED module must be less than 10m.
- The length of the data cables at the BUS input/output (DALI, Ethernet or other) should be as per specification of the respective protocols and regulations.
- The length of the connecting cables between the control inputs (pushbutton, 0-10 V/1-10 V, potentiometer or other) and the product must be less than 10m.

### Operation and use

*Solely use the product when its working correctly. If not, switch the power off immediately and advise an electrical specialist in the following cases:*

- Damage is visible on the product.
- The product does not function.
- Smoke or steam rises from the product.
- Crackling sounds are noticeable.
  
- Repairs on the installation may only be performed by qualified electricians.
- Product repairs may solely be done by Triolight B.V.
- Use a suitable power supply.
- Do not drive the product on other voltages than described in their datasheet/product specifications.
- Do not fasten anything on the product, same applies for hanging.
- Children may not play unsupervised with electrical products as they cannot judge the dangers in dealing with electrical circuits correctly.

### Cleaning and maintenance

- *Attention:* Disconnect the power before maintenance and cleaning.
- Paints, solvents and corrosive cleaning chemicals may not contact and thus affect the product.

### Environment and waste

- This product may not be treated as household waste. Dispose of the material through the waste recycling of electrical and electronic equipment.

### Documentation

- For an updated version of the device manual visit our website: [www.liniled.com](http://www.liniled.com).

## Product drawing

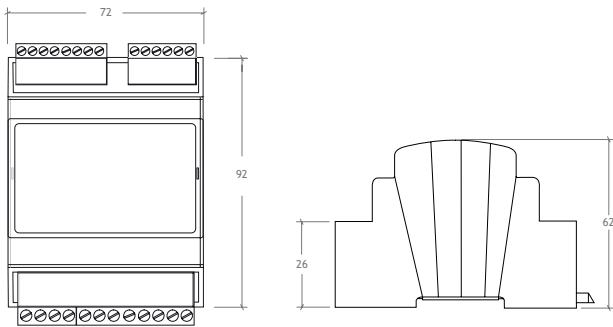

## Technical specifications

### Dim 4-DALI-PRO

Product code	11136
Input signal	DALI (4 analogue inputs 0-10V/1-10V/Potentiometer/Dry contacts for N.O. pushbuttons)
Input voltage ( $V_{in}$ )	10.8 ... 52.8 V DC
Input current ( $I_{in}$ ) <sup>1</sup>	= $I_{out}$
Max. load @ 24 V DC <sup>1</sup>	480 W (high power mode)/240 W (normal mode)
Output channels	4
Output current per channel <sup>1,2</sup>	Max. 5 A
Output signal	D-PWM, 16 bit resolution
Output type	Constant voltage, common anode
Output voltage ( $V_{out}$ )	= $V_{in}$
Typical efficiency	> 95%
Standby power @ 24 V DC	Max. 500 mW
Dimming range	0.1 ... 100% (1 ... 100% in N.O. push mode)
Dimming frequency	300/600/1200 Hz (selectable)
IP rating	IP10
Storage temperature	-40 ... 60°C
Ambient operating temperature ( $T_a$ ) <sup>1</sup>	-40 ... 60°C
Dimensions	72 x 92 x 62 mm
Packaging dimensions	125 x 85 x 71 mm
Weight	125 g
Housing material	Self-extinguishing PC/ABS
Thermal shutdown <sup>3</sup>	150°C
Wiring	Buttons & BUS: 1.5 mm <sup>2</sup> solid - 1.0 mm <sup>2</sup> stranded - 30/14 AWG Power & LEDs: 2.5mm <sup>2</sup> solid - 1.5mm <sup>2</sup> stranded - 30/12 AWG
Control supply current	0.5 mA (only for 1-10V)
Control required current (Max.)	0.1 mA (not for 1-10V)

<sup>1</sup> Maximum value, dependent on the ventilation and environmental conditions.

<sup>2</sup> Max load definition ( $I_{TOT} = I_{L1} + I_{L2} + I_{L3} + I_{L4}$ ): 10 A (normal power mode)/20 A (high power mode).

<sup>3</sup> Provided by MOSFET internal thermal shut down.

## Protection circuits

---

OTP	Over temperature protection <sup>3</sup>
OVP	Over voltage protection <sup>4</sup>
UVP	Under voltage protection <sup>4</sup>
RVP	Reverse polarity protection <sup>4</sup>
IFP	Input fuse protection <sup>4</sup>
SCP	Short circuit protection
OCP	Open circuit protection
CLP	Current limit protection

<sup>3</sup> Provided by MOSFET internal shut down.

<sup>4</sup> Only control logic protection.

## Reference standards

---

This product is designed and produced according to following standards.

EN 61347-1:2008 + A1:2011 + A2:2013	Lamp control gear - Part 1: General and safety requirements
EN 55015:2013+A1:2015	Limits and methods of measurement of radio disturbance characteristics of electrical lighting and similar equipment
EN 61547:2009	Equipment for general lighting purposes - EMC immunity requirements
EN 50581:2012	Technical documentation for the assessment of electrical and electronic products with respect to the restriction of hazardous substances
IEC/EN 62386-101	Digital addressable lighting interface - Part 101: General requirements - System
IEC/EN 62386-102	Digital addressable lighting interface - Part 102: General requirements - Control gear
IEC/EN 62386-207	Digital addressable lighting interface - Part 207: Particular requirements for control gear - LED modules (device type 6)
IEC 60929-E.2.1	Control interface for controllable ballasts - control by d.c. voltage - functional specification
ANSI E 1.3	Entertainment Technology - Lighting Control Systems - 0 to 10V Analog Control Specification

## Configuration setup

- ⚠ Turn OFF power before installation.
- ⚠ Before you start the configuration make sure all the switches are OFF.

Setting up the driver is explained in this chapter.

The 12 way dip-switch (under the plastic top cover) can provide an extensive set of possible configurations. Functionality for the corresponding switches and possible options is visible in the overview below. For configuration of the dip-switches and rotary selectors it is necessary to remove the top-cover from the device.

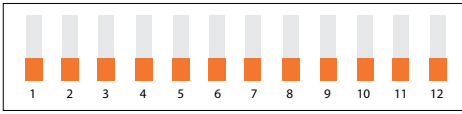
	Rotary selectors: for addressing			Dip-switches: for configuration			
							
<b>Step</b>	1	2	3	4	5	6	7
	Open the driver	Load type / parallel outputs	Mapping	Dimming curve	Control input type	Output PWM frequency	Close the driver
<b>Options</b>		<ul style="list-style-type: none"> <li>- Single colour</li> <li>- RGB</li> <li>- RGBW</li> <li>- TW</li> <li>- Parallel output</li> </ul>	<ul style="list-style-type: none"> <li>- Dimmer</li> <li>- Dim to warm</li> <li>- Tunable White</li> <li>- Smart</li> <li>- RGB</li> <li>- Master/RGB/ Strobe</li> </ul>	<ul style="list-style-type: none"> <li>- Default</li> <li>- Exponential</li> <li>- Quadratic</li> <li>- Linear</li> </ul>	<ul style="list-style-type: none"> <li>- DALI BUS setup</li> <li>- Analogue</li> <li>- Both</li> </ul>	<ul style="list-style-type: none"> <li>- 300 Hz</li> <li>- 600 Hz</li> <li>- 1200 Hz</li> </ul>	
<b>See page</b>	7	8/9	10	11	11/12	13	13

### STEP 1

## Opening the driver

For the dip-switch and rotary selectors configuration it is necessary to remove the top-cover from the device.

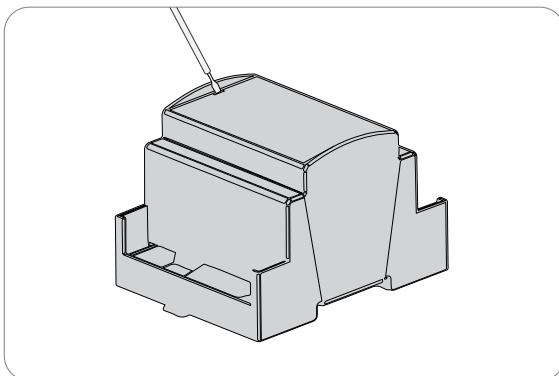

Insert the tip of a flat screwdriver (4.0 x 50mm or similar) in the small opening on top of the driver.

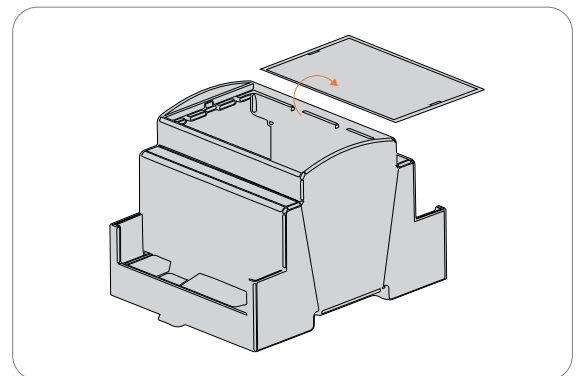







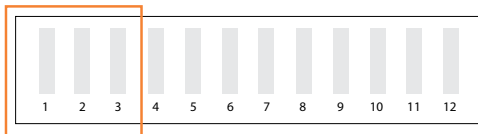

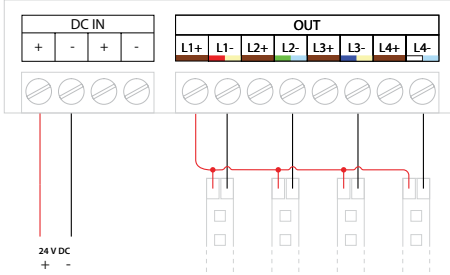
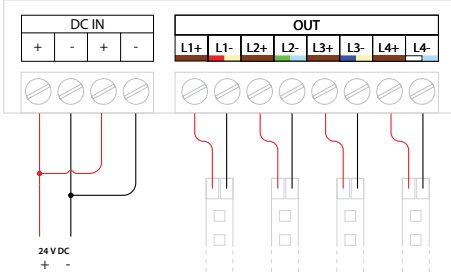
Remove the top cover and store it for later use.

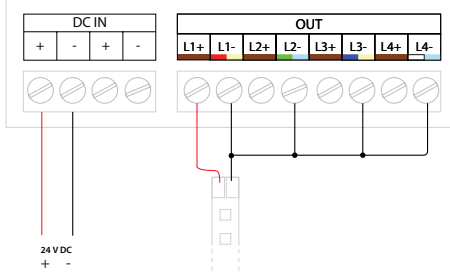
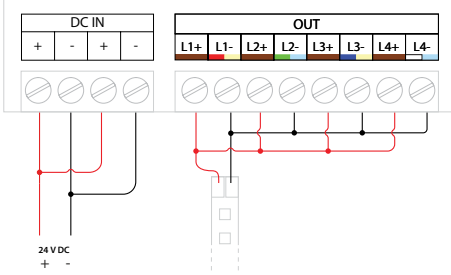

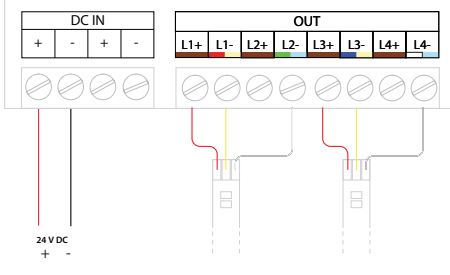
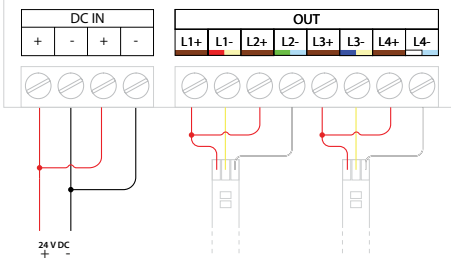

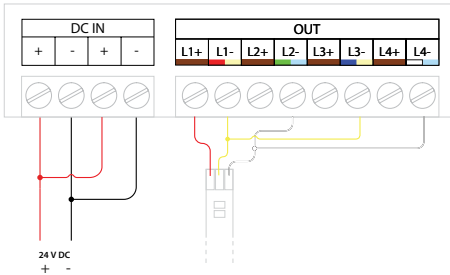
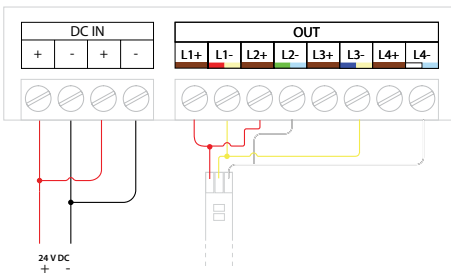
## Load type and parallel output

Use switch 1 and 2 for the load type. Use switch 3 for the parallel output.

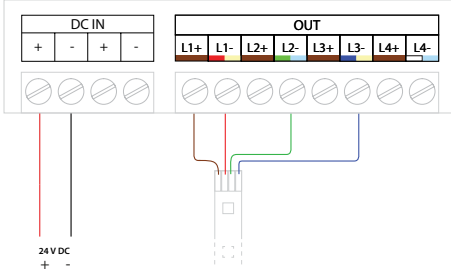
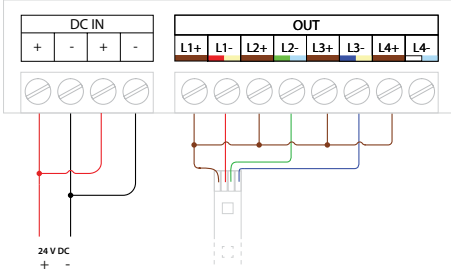

Load type	Normal mode Total current 0 - 10 A max	High power mode Total current 0 - 20 A max	Settings
 <p><b>Single colour</b> Up to 4 loads</p>			
 <p><b>Single colour</b> Parallel outputs with increased current</p>			
 <p><b>Tunable white</b> Up to 2 loads</p>			
 <p><b>Tunable white</b> Parallel outputs with increased current</p>			

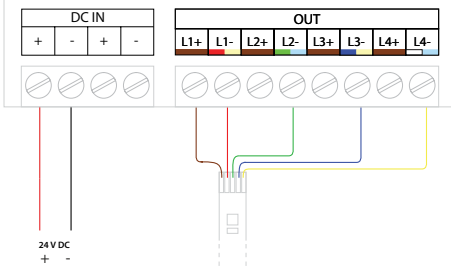
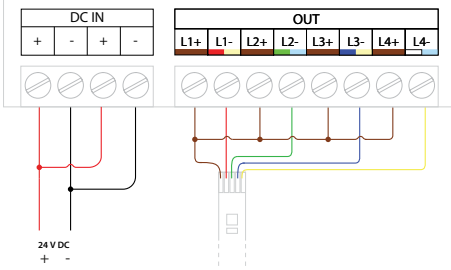

Load type	Normal mode Total current 0 - 10 A max	High power mode Total current 0 - 20 A max	Settings
 <p><b>RGB</b> Up to 4 loads</p>			
 <p><b>RGBW</b> Parallel outputs with increased current</p>			

STEP 3

## Mapping

Use switch 4, 5 and 6 for mapping.

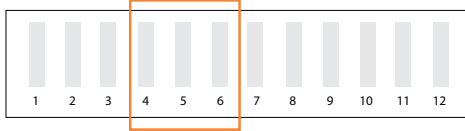

Single colour	Tunable White	RGB	RGBW	
Dimmer	Dimmer	Dimmer	Dimmer	
N/A	Dim to warm	Dim to warm	Dim to warm	
N/A	Tunable White	Tunable White	Tunable White	
N/A	N/A	Smart <sup>1</sup>	Smart <sup>1</sup>	
N/A	N/A	RGB	RGB <sup>2</sup>	
N/A	N/A	RGBW <sup>3</sup>	RGBW	
N/A	N/A	Master/RGB/Strobe	Master/RGB/Strobe	
N/A	N/A	Master/RGBW/Strobe <sup>3</sup>	Master/RGBW/Strobe	

<sup>1</sup> Intensity, temperature correction, colour hue & rotation, saturation and strobe.

<sup>2</sup> Converts RGB --> RGBW.

<sup>3</sup> Converts RGBW --> RGB.

**STEP 4****Dimming curve**

Set the dimming curve of the driver by using switch 7 and 8.

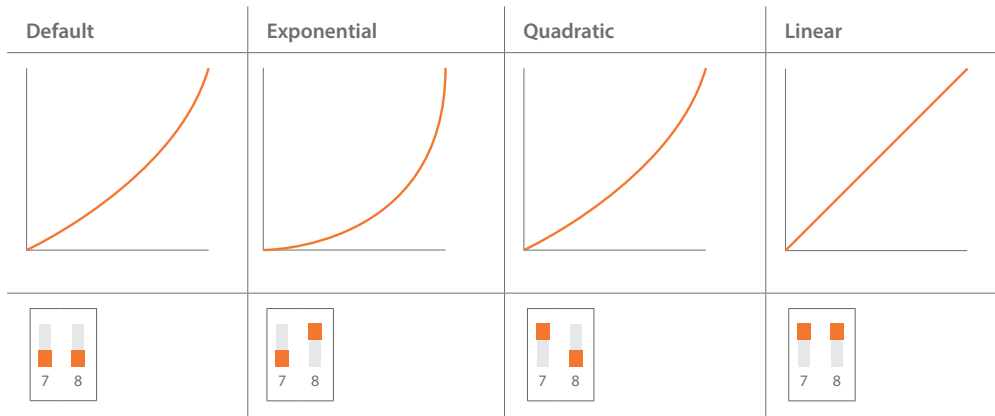
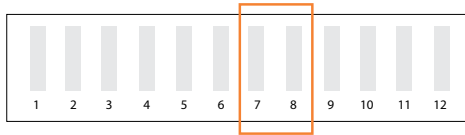
**STEP 5****Control input type**

In this step you can choose to set the driver up as follows:

**1. DALI BUS setup**

Setting up the driver according to DALI BUS setup gives the following options:

DALI channels map

*Page 18 ... 20*

DALI commands

*Page 21*

**2. Analogue control inputs**

Setting up the driver according to analogue control inputs gives the following options:

- Control input functionalities

*Page 14 ... 15*

- Operation functions N.O. pushbutton

*Page 16*

- Operation functions 0/1-10 V and potentiometers

*Page 17*

**3. Both**

When both input types are used this will result in a control hierarchy where DALI is prevalent to the analogue control inputs, except in the absence of a DALI signal:

- If the control input is a N.O. pushbutton, the control passes to control input in the event of a contact closure.

- If the control input is a 0-10 V or 1-10 V the control passes immediately to the control input.

In case of absence of analogue control inputs, the DALI BUS control input is active and stays there until the signal is present.

## DALI BUS setup

In DALI BUS setup all channels are controlled by an external DALI controller. The wiring scheme is displayed below and the behaviour of the LED is also explained.

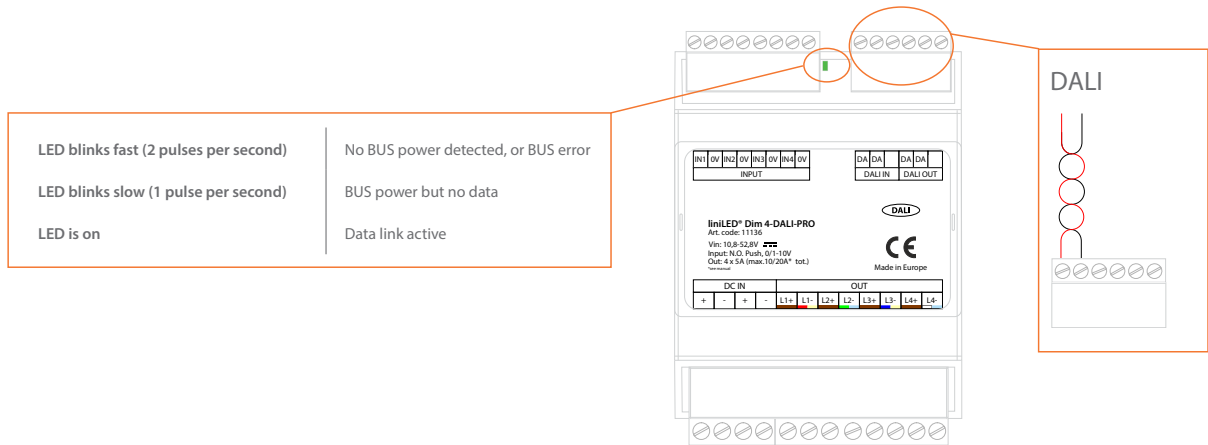

## Addressing



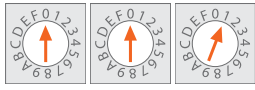
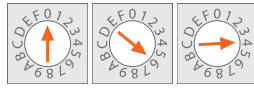
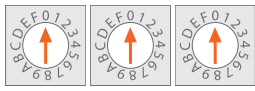

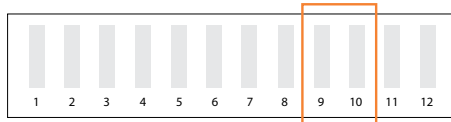

The following addressing options are supported by the driver:

By rotary selectors	First channel address: 001		to	
Simplified method (one ballast connected at a time)	Address defined by DALI: 000 (default)			
Random address allocation				

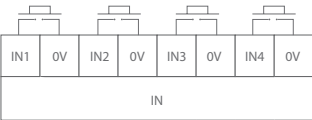
## Analogue control input

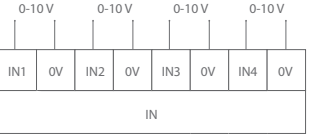
Use switch 9 and 10 to set one of the four input type options displayed below. Use the corresponding connection diagram to connect the control input.

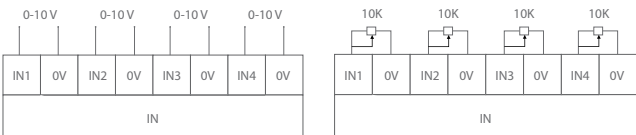

Input Type	Description	Connection diagram	Settings
Push	N.O. pushbutton NO memory		
	N.O. pushbutton memory		
0 - 10 V	Analogue 0 - 10 V		
1 - 10 V	Analogue 1 - 10 V & Potentiometer		

Use 10 kΩ linear potentiometers

## STEP 6

### Output frequency (optional)

The frequency of PWM dimming might interfere with other optical devices such as video cameras which may cause an on-screen flickering effect. In case of any PWM frequency interference, select another output frequency to reduce/eliminate the PWM flickering interference.

Use switch 11 and 12 to adjust output frequency settings.

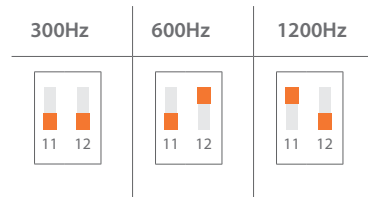
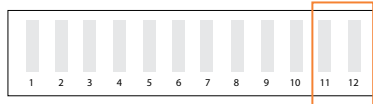

## STEP 7

### Closing the driver

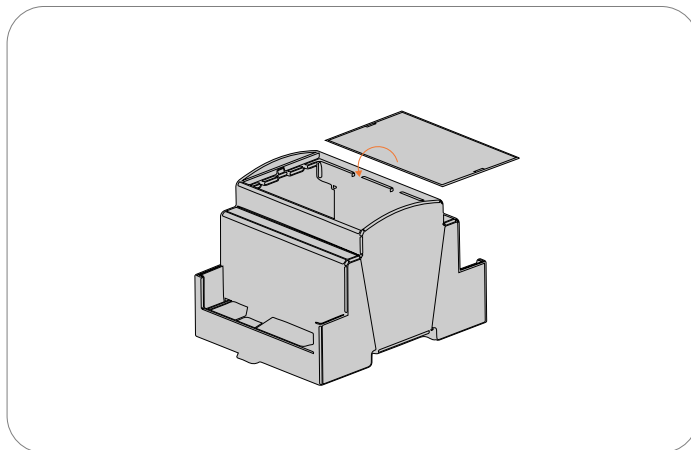

Put the top cover back on the plastic casing and mind the orientation of the label.

## Control input functionalities

According to the selected load type and map the control input is defined.

### ●●● Single colour and Tunable White

Load type	Map	Input 1	Input 2	Input 3	Input 4
● Single colour Up to 4 loads	Dimmer	 Dim load 1	 Dim load 2	 Dim load 3	 Dim load 4
● Single colour Parallel outputs	Dimmer	 Dim			
●● Tunable White Up to 2 loads	Dimmer	 Dim load 1		 Dim load 2	
●● Tunable White Parallel outputs	Dimmer	 Dim			
●● Tunable White Up to 2 loads	Dim to warm	 Dim to warm load 1		 Dim to warm load 2	
●● Tunable White Parallel outputs	Dim to warm	 Dim to warm			
●● Tunable White Up to 2 loads	Tunable White	 Dim load 1	 CCT load 1	 Dim load 2	 CCT load 2
●● Tunable White Parallel outputs	Tunable White	 Dim	 CCT		









 RGB and RGBW

Load type	Map	Input 1	Input 2	Input 3	Input 4
 RGB & RGBW	Dimmer	 Dim			
 RGB & RGBW	Dim to warm	 Dim to warm			
 RGB & RGBW	Tunable White	 Dim	 CCT		
 RGB & RGBW	Smart	 Dim	 CCT	 Colour	 Saturation
 RGB & RGBW	RGB	 Red	 Green	 Blue	
 RGB & RGBW	RGBW	 Red	 Green	 Blue	 White
 RGB & RGBW	MRGB+	 Red	 Green	 Blue	
 RGB & RGBW	MRGBW+	 Red	 Green	 Blue	 White

## Operation functions

### N.O. pushbutton









Based on the control input type (configuration setup - step 5, page 11) the available functions for the N.O. pushbutton (with and without memory) are in the table below.

Symbol	Description	Action	Result
	<b>Dimmer</b> Dim the light following the selected dimming curve, keeping a constant colour temperature. Soft turn on with 200 ms fade time, soft turn off with 1s fade time.	Click Double click Long pressure from off Long pressure from on	Turn ON/OFF channel Turn on channel at 100% Turn on at 1% (night time) Dim UP/DOWN
	<b>Dim to warm</b> Dim the light following the selected dimming curve. The colour temperature increases with intensity. Soft turn on with 200 ms fade time, soft turn off with 1s fade time.	Click Double click Long pressure from off Long pressure from on	Turn ON/OFF channel Turn on channel at 100% Turn on at 1% (night time) Dim UP/DOWN
	<b>CCT: Colour correction temperature/white balance (based on load type)</b> <ul style="list-style-type: none"> <li><b>Tunable White:</b> Change the colour temperature, keeping a constant intensity. Neutral white = 50% cold white + 50% warm white.</li> <li><b>RGB:</b> Change the equivalent colour temperature. Neutral white = equal values of R, G and B.</li> <li><b>RGBW:</b> Balance the white from the white output to the composite RGB output. Neutral white = 50% White + 50% RGB.</li> </ul>	Double click Long pressure (>1s) from on	Neutral white Change colour temperature UP/DOWN (Cold - Warm or White - RGB)
	<b>Colour rotation and selection</b> Change the colour or colour rotation speed.	Click Double click Long pressure (>1s) from on	Start/stop colour rotation Change from colour (or colour rotation) to white and vice-versa Change the rotation speed, selected from 4 predefined levels the selected speed is visualized as a white strobe light
	<b>Colour saturation</b> Change colour saturation: vivid colours - pastel colours.	Click Double click Long pressure (>1s) from white Long pressure (>1s) from colour	Toggle between white and colours Maximum saturation - vivid colours Minimum saturation - pastel colours Change the saturation value
	<b>Red</b> Linear change red channel.	Click Double click Long pressure from off Long pressure from on	Turn ON/OFF channel Turn on channel at 100% Turn on at 1% Dim UP/DOWN
	<b>Green</b> Linear change green channel.	Click Double click Long pressure from off Long pressure from on	Turn ON/OFF channel Turn on channel at 100% Turn on at 1% Dim UP/DOWN
	<b>Blue</b> Linear change blue channel.	Click Double click Long pressure from off Long pressure from on	Turn ON/OFF channel Turn on channel at 100% Turn on at 1% Dim UP/DOWN
	<b>White</b> Linear change white channel.	Click Double click Long pressure from off Long pressure from on	Turn ON/OFF channel Turn on channel at 100% Turn on at 1% Dim UP/DOWN





## 0/1-10 V and potentiometers

Based on the control input type (configuration setup - step 5, page 11) the available functions for the 0-10 V/1-10 V and potentiometers (with and without memory) are in the table below.

Symbol	Description	Action	Output
	<b>Dimmer</b> Dim the light following the selected dimming curve, keeping a constant colour temperature. Minimum intensity = 0.1%	Below 1 V  10 V	Turn OFF channel  Turn ON channel at 100%
	<b>Dim to warm</b> Dim the light following the selected dimming curve. The colour temperature increase with intensity. Minimum intensity = 0.1%	Below 1 V  10 V	Turn OFF channel  Turn ON channel at 100%
	<b>CCT: Colour correction temperature/ white balance (based on load type)</b> <ul style="list-style-type: none"> <li><b>Tunable White:</b> Change the colour temperature, keeping a constant intensity. Neutral white = 50% cold white + 50% warm white.</li> <li><b>RGB:</b> Change the equivalent colour temperature. Neutral white = equal values of R G B.</li> <li><b>RGBW:</b> Balance the white from the white output to the composite RGB output. Neutral white = 50% White + 50% RGB.</li> </ul>	Below 1 V  ↕  10 V	Warm colours  ↕  Cold colours
	<b>Colour rotation and selection</b> Change the colour.	Below 1 V  ↕  10 V	Red colour  ↕ Yellow Green Cyan Blue Magenta  Red colour
	<b>Colour saturation</b> Change the colour saturation: vivid colours - pastel colours.	Below 1 V  ↕  10 V	Pastel colours  ↕  Vivid colours
	<b>Red</b> Linear change red channel.	Below 1 V  10 V	Turn OFF channel  Turn ON channel at 100%
	<b>Green</b> Linear change green channel.	Below 1 V  10 V	Turn OFF channel  Turn ON channel at 100%
	<b>Blue</b> Linear change blue channel.	Below 1 V  10 V	Turn OFF channel  Turn ON channel at 100%
	<b>White</b> Linear change white channel.	Below 1 V  10 V	Turn OFF channel  Turn ON channel at 100%

## DALI channels map







### ● Single colour - Up to 4 loads

Mapping	Address	Function	
Dimmer	+ 0	Dimmer 1 (0 ... 254)	
	+ 1	Dimmer 2 (0 ... 254)	
	+ 2	Dimmer 3 (0 ... 254)	
	+ 3	Dimmer 4 (0 ... 254)	



### ● Single colour - Parallel outputs (Macro dimmer)

Mapping	Address	Function	
Dimmer	+ 0	Dimmer 1 (0 ... 254)	

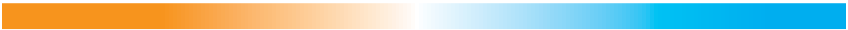





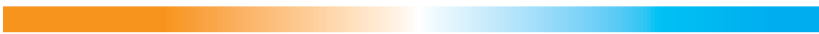

### ●● Tunable white - Up to 2 loads

















Mapping	Address	Function	
Dimmer	+ 0	Dimmer 1 (0 ... 254)	
	+ 1	Dimmer 2 (0 ... 254)	
Dim to warm	+ 0	Dimmer 1 (0 ... 254)	
	+ 1	Dimmer 2 (0 ... 254)	
Tunable White	+ 0	Dimmer 1 (0 ... 254)	
	+ 1	Colour correction 1 (0 ... 254)	
	+ 2	Dimmer 2 (0 ... 254)	
	+ 3	Colour correction 2 (0 ... 254)	

 Tunable white - Parallel outputs

Mapping	Address	Function	
Dimmer	1	Dimmer (0 ... 254)	
Dim to warm	1	Dimmer (0 ... 254)	
Tunable White	1	Dimmer (0 ... 254)	
	2	Colour correction (0 ... 254)	

 RGB & RGBW

Mapping	Address	Function																																
Dimmer	+ 0	Master dimmer (0 ... 254)																																
Dim to warm	+ 0	Master dimmer (0 ... 254)																																
Tunable White	+ 0	Master dimmer (0 ... 254)																																
	+ 1	Colour correction (0 ... 254)																																
Smart	+ 0	Master dimmer (0 ... 254)																																
	+ 1	Colour correction (0 ... 254)																																
	+ 2	Hue (0 ... 254)																																
	+ 3	Hue rotation time	<table border="1"> <thead> <tr> <th>Stop</th> <th>30m</th> <th>15m</th> <th>6m</th> <th>3m</th> <th>1m</th> <th>30s</th> <th>15s</th> <th>6s</th> <th>3s</th> </tr> </thead> <tbody> <tr> <td>0..25</td> <td>26..51</td> <td>52..76</td> <td>77..102</td> <td>103..127</td> <td>128..153</td> <td>154..179</td> <td>180..204</td> <td>205..230</td> <td>231..254</td> </tr> </tbody> </table>	Stop	30m	15m	6m	3m	1m	30s	15s	6s	3s	0..25	26..51	52..76	77..102	103..127	128..153	154..179	180..204	205..230	231..254											
	Stop	30m	15m	6m	3m	1m	30s	15s	6s	3s																								
0..25	26..51	52..76	77..102	103..127	128..153	154..179	180..204	205..230	231..254																									
+ 4	Saturation (0 ... 254)																																	
+ 5	Strobe Rate	<table border="1"> <tbody> <tr> <td>ON</td> <td>blackout</td> <td>1fps</td> <td>2fps</td> <td>3fps</td> <td>4fps</td> <td>5fps</td> <td>6fps</td> </tr> <tr> <td>0..15</td> <td>16..31</td> <td>21..47</td> <td>48..63</td> <td>64..79</td> <td>80..95</td> <td>96..111</td> <td>112..127</td> </tr> <tr> <td>7fps</td> <td>8fps</td> <td>9fps</td> <td>10fps</td> <td>12fps</td> <td>14fps</td> <td>16fps</td> <td>ON</td> </tr> <tr> <td>128..143</td> <td>144..159</td> <td>160..175</td> <td>176..191</td> <td>192..207</td> <td>208..223</td> <td>224..239</td> <td>240..254</td> </tr> </tbody> </table>	ON	blackout	1fps	2fps	3fps	4fps	5fps	6fps	0..15	16..31	21..47	48..63	64..79	80..95	96..111	112..127	7fps	8fps	9fps	10fps	12fps	14fps	16fps	ON	128..143	144..159	160..175	176..191	192..207	208..223	224..239	240..254
ON	blackout	1fps	2fps	3fps	4fps	5fps	6fps																											
0..15	16..31	21..47	48..63	64..79	80..95	96..111	112..127																											
7fps	8fps	9fps	10fps	12fps	14fps	16fps	ON																											
128..143	144..159	160..175	176..191	192..207	208..223	224..239	240..254																											

Map	Address	Function																																
RGB	+ 0	R (0 ... 254)																																
	+ 1	G (0 ... 254)																																
	+ 2	B (0 ... 254)																																
RGBW	+ 0	R (0 ... 254)																																
	+ 1	G (0 ... 254)																																
	+ 2	B (0 ... 254)																																
	+ 3	W (0 ... 254)																																
MRGB+	+ 0	Master dimmer (0 ... 254)																																
	+ 1	R (0 ... 254)																																
	+ 2	G (0 ... 254)																																
	+ 3	B (0 ... 254)																																
	+ 4	Strobe rate	<table border="1" data-bbox="518 1149 1101 1305"> <thead> <tr> <th>ON</th> <th>blackout</th> <th>1fps</th> <th>2fps</th> <th>3fps</th> <th>4fps</th> <th>5fps</th> <th>6fps</th> </tr> </thead> <tbody> <tr> <td>0..15</td> <td>16..31</td> <td>21..47</td> <td>48..63</td> <td>64..79</td> <td>80..95</td> <td>96..111</td> <td>112..127</td> </tr> <tr> <th>7fps</th> <th>8fps</th> <th>9fps</th> <th>10fps</th> <th>12fps</th> <th>14fps</th> <th>16fps</th> <th>ON</th> </tr> <tr> <td>128..143</td> <td>144..159</td> <td>160..175</td> <td>176..191</td> <td>192..207</td> <td>208..223</td> <td>224..239</td> <td>240..254</td> </tr> </tbody> </table>	ON	blackout	1fps	2fps	3fps	4fps	5fps	6fps	0..15	16..31	21..47	48..63	64..79	80..95	96..111	112..127	7fps	8fps	9fps	10fps	12fps	14fps	16fps	ON	128..143	144..159	160..175	176..191	192..207	208..223	224..239
ON	blackout	1fps	2fps	3fps	4fps	5fps	6fps																											
0..15	16..31	21..47	48..63	64..79	80..95	96..111	112..127																											
7fps	8fps	9fps	10fps	12fps	14fps	16fps	ON																											
128..143	144..159	160..175	176..191	192..207	208..223	224..239	240..254																											
MRGBW+	+ 0	Master dimmer (0 ... 254)																																
	+ 1	R (0 ... 254)																																
	+ 2	G (0 ... 254)																																
	+ 3	B (0 ... 254)																																
	+ 4	W (0 ... 254)																																
+ 5	Strobe rate	<table border="1" data-bbox="518 1821 1101 1977"> <thead> <tr> <th>ON</th> <th>blackout</th> <th>1fps</th> <th>2fps</th> <th>3fps</th> <th>4fps</th> <th>5fps</th> <th>6fps</th> </tr> </thead> <tbody> <tr> <td>0..15</td> <td>16..31</td> <td>21..47</td> <td>48..63</td> <td>64..79</td> <td>80..95</td> <td>96..111</td> <td>112..127</td> </tr> <tr> <th>7fps</th> <th>8fps</th> <th>9fps</th> <th>10fps</th> <th>12fps</th> <th>14fps</th> <th>16fps</th> <th>ON</th> </tr> <tr> <td>128..143</td> <td>144..159</td> <td>160..175</td> <td>176..191</td> <td>192..207</td> <td>208..223</td> <td>224..239</td> <td>240..254</td> </tr> </tbody> </table>	ON	blackout	1fps	2fps	3fps	4fps	5fps	6fps	0..15	16..31	21..47	48..63	64..79	80..95	96..111	112..127	7fps	8fps	9fps	10fps	12fps	14fps	16fps	ON	128..143	144..159	160..175	176..191	192..207	208..223	224..239	240..254
ON	blackout	1fps	2fps	3fps	4fps	5fps	6fps																											
0..15	16..31	21..47	48..63	64..79	80..95	96..111	112..127																											
7fps	8fps	9fps	10fps	12fps	14fps	16fps	ON																											
128..143	144..159	160..175	176..191	192..207	208..223	224..239	240..254																											

## DALI commands

The table below is an overview of the available DALI commands.

### Standard commands

Direct art power	V
Off	V
Up	V
Down	V
Step up	V
Step down	V
Recall max level	V
Recall min level	V
Step down and off	V
On and step up	V
Go to scene (0 to 15)	V
Reset	V
Store actual level in the DTR	V
Store the DTR as max level	V
Store the DTR as min level	V
Store the DTR as system failure level	V
Store the DTR as power on level	V
Store the DTR as fade time	V
Store the DTR as fade rate	V
Store the DTR as scene (0 to 15)	V
Remove from scene (0 to 15)	V
Add to group (0 to 15)	V
Remove from group (0 to 15)	V
Store DTR as short address	V
Query status	V
Query ballast	V
Query lamp failure	V
Query lamp power on	V
Query limit error	V
Query reset state	V
Query missing short address	V
Query version number	V
Query content	V

Query device type	V
Query physical minimum level	V
Query power failure	V
Query content DTR1	V
Query content DTR2	V
Query actual	V
Query max level	V
Query min level	V
Query power on level	V
Query system failure level	V
Query fade time/fade rate	V
Query scene level (0 to 15)	V
Query groups 0-7	V
Query groups 8-15	V
Query random address H	V
Query random address M	V
Query random address L	V

### Special commands

Terminate	V
Data transfer register	V
Initialize	V
Randomize	V
Compare	V
Withdraw	V
Searchaddr H	V
Searchaddr M	V
Searchaddr L	V
Program short address	V
Verify short address	V
Query short address	V
Data transfer register 1	V
Data transfer register 2	V

## Symbols

---



Manufacturer's declaration that the product meets the applicable EC directives.



Restriction of Hazardous Substances (RoHS): product complies with the RoHS directive and each homogeneous material does not exceed the limits for the materials mentioned under the RoHS directive (Pb, Hg, Cd, Cr6+, PBB and PBDE).



Protected against ingress of solid objects over 50 mm, e.g. accidental touch by persons hands, but no protection against deliberate contact with a body part and no protection against liquids.



Electrical appliance class III: this product is designed to be supplied from an extra-low voltage ( $\leq 60.0$  V DC or  $\leq 42.4$  V AC).



Operating voltage of 12-48 V DC (please check or refer to LED product specification).



System guarantee of 5 years when the complete system consist of liniLED® products with the 5 years system warranty logo. Terms & conditions apply.

## Disclaimer

---

The published information is checked to be as accurate as possible, however Triolight B.V. or any reseller of liniLED® cannot be held liable for any damages resulting from misprints, errors, modifications or outdated information. No legal rights can be derived from this document. Triolight B.V. reserves the right to modify the information without informing the customers. Please check for the latest version on [www.liniLED.com](http://www.liniLED.com). This product should not be used in applications, devices or systems where incorrect operation of the product may result in personal injury (includes emergency lighting) without written permission from the board of Triolight B.V. If nevertheless used in such applications, devices or systems, Triolight B.V. cannot be held liable for any resulting injury. liniLED® is a registered trademark of Triolight B.V.

