

LENA 55×35 SUSPENDED / Datasheet

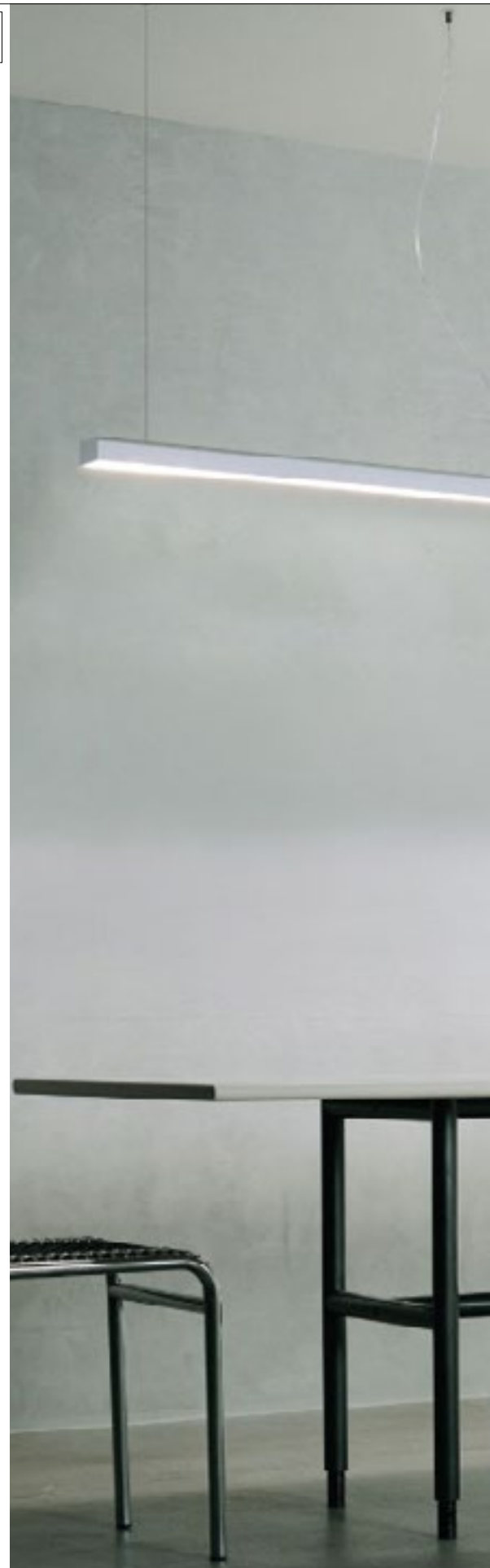
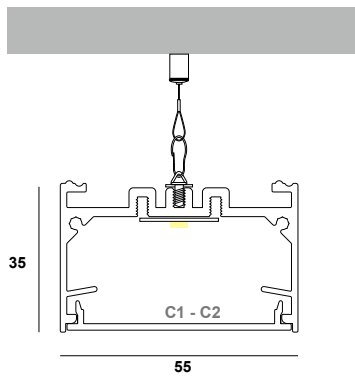
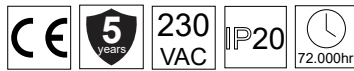

material	Pcb details	CRI	lumen output / W
Extruded aluminium	Zhaga-Compliant Dimensions	Ra>80 (Ra>90 on request)	up to 195 Lm/W

covers	profile color	CCT	Dimming options
Acrylic Diffuser (-C1-)	Anodised (AN)	3000K (3)	Push
	Black (BL)	4000K (4)	DALI
	White (WH)	5000K (5)	TRIAC 0/1-10V
Acrylic Microprismatic (-C2-)	RAL (RL)	6500K (6)	CASAMBI
			Analog 0/1-10V

S5535 - XX - XXX - X - XX - XX - X - XXX

(a)	(b)	(c)	(d)	(e)	(f)	(g)	(h)
Κωδικός Γραμμικού Linear Code	Κατηγορία Category	Μήκος Length	Θερμοκρασία φωτός Color Temperature	Χρώμα προφίλ Profile color	Κάλυμμα Cover	Αυξομείωση έντασης φωτός Dimming	Τοποθέτηση τροφοδοτικού Power supply installation

ΠΕΡΙΕΧΟΜΕΝΑ

Datasheet	1
Product Code generator	2
Lumen output tables	3
Οδηγίες κρεμαστής τοποθέτησης	4

LENA 55×35 SUSPENDED / Code Generator

a. **S5535-**

b. **Κατηγορία απόδοσης / Output category**

Ανατρέξτε στους πίνακες των γραμμικών και διαλέξτε την απόδοση που απαιτεί ο χώρος σας. Η ισχύς προκύπτει από την κατηγορία απόδοσης (**1A / 1B / 2A / 2B**) και από τη θερμοκρασία φωτός (**3000K / 4000K / 5000K / 6500K**) που θα επιλέξετε.

Refer to the linear tables and choose the output that your space requires. Wattage follows from the output category (**1A / 1B / 2A / 2B**) and the Kelvins (**3000K / 4000K / 5000K / 6500K**) you choose.

 1A (13,5 W/m) 1B (20 W/m)	 2A (40,5 W/m) 2B (60,5 W/m)
--	---

c. **Μήκος / length**

Διατίθεται και σε μήκη πολλαπλάσια των 14 εκατοστών, έως 600cm. / Available in lengths that are multiples of 14 centimeters, up to 600cm.

length	code	length	code	length	code	length	code
57cm	-57-	169cm	-169-	281cm	-281-	393cm	-393-
85cm	-85-	197cm	-197-	309cm	-309-	421cm	-421-
113cm	-113-	225cm	-225-	337cm	-360-	449cm	-449-
141cm	-141-	253cm	-253-	365cm	-365-		

d. **Θερμοκρασία φωτός / Kelvin**

 3000K warm white (-3-)	 4000K neutral white (-4-)	 5000K cold white (-5-)	 6500K ultra cold white (-6-)
---	--	--	---

e. **Χρώμα προφίλ / Profile color**

 Anodised (-AN-)	 Black (-BL-)	 White (-WH-)	 More RAL colors (-RL-)	 Nickeling (-NK-)
---	--	--	---	--

f. **Κάλυμμα / cover**

 Acrylic Diffuser (-C1-)	 Acrylic Microprismatic (-C2-)
---	--

g. **Αυξομείωση έντασης φωτός \ Dimming option**

 dimmable	Yes (D) No (_)
---	------------------------------------

Τοποθέτηση τροφοδοτικού / Power supply installation

Πάνω στο προφίλ με ροζέτα /
On the profile with rosette

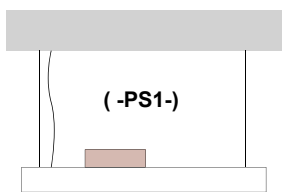

Δίπλα στο προφίλ σε ροζέτα /
To the side of the profile in rosette

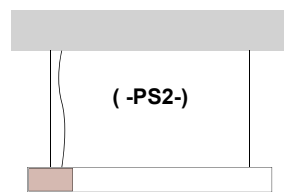

Σε ροζέτα στην οροφή /
In rosette on the ceiling

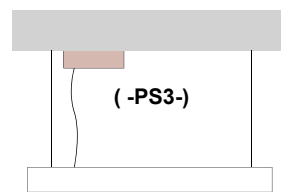

Κρυφό / Hidden
Με πρόσβαση στο τροφοδοτικό /
With access to the power supply

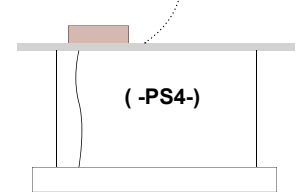

Παράδειγμα κωδικού / Code example

LENA 55×35 SUSPENDED 90cm 1A 3000K Black with Diffuser Dimmable (Hidden power supply)

SKU: S5535-1A-90-3-BL-C1-D-PS4

LENA 55×35 SUSPENDED / Lumen output tables

CATEGORY 1A 350mA (1A)	code	length	watt	lumens 3000K	lumens 4000K	lumens 5000K	lumens 6500K
	S5535-1A-57	57cm	7.8	1390	1470	1470	1440
	S5535-1A-85	85cm	11.7	2085	2205	2205	2160
	S5535-1A-113	113cm	15.6	2780	2940	2940	2880
	S5535-1A-141	141cm	19.5	3475	3675	3675	3600
	S5535-1A-169	169cm	23.4	4170	4410	4410	4320
	S5535-1A-197	197cm	27.3	4865	5145	5145	5040
	S5535-1A-225	225cm	31.2	5560	5880	5880	5760
	S5535-1A-253	253cm	35.1	6255	6615	6615	6480
	S5535-1A-281	281cm	39	6950	7350	7350	7200
	S5535-1A-309	309cm	42.9	7645	8085	8085	7920
	S5535-1A-337	337cm	46.8	8340	8820	8820	8640
	S5535-1A-365	365cm	50.7	9035	9555	9555	9360
	S5535-1A-393	393cm	54.6	9730	10290	10290	10080
	S5535-1A-421	421cm	58.5	10425	11025	11025	10800
	S5535-1A-449	449cm	62.4	11120	11760	11760	11520

CATEGORY 1B 500mA (1B)	code	length	watt	lumens 3000K	lumens 4000K	lumens 5000K	lumens 6500K
	S5535-1B-57	57cm	11.6	1960	2070	2070	2020
	S5535-1B-85	85cm	17.4	2940	3105	3105	3030
	S5535-1B-113	113cm	23.2	3920	4140	4140	4040
	S5535-1B-141	141cm	29	4900	5175	5175	5050
	S5535-1B-169	169cm	34.8	5880	6210	6210	6060
	S5535-1B-197	197cm	40.6	6860	7245	7245	7070
	S5535-1B-225	225cm	46.4	7840	8280	8280	8080
	S5535-1B-253	253cm	52.2	8820	9315	9315	9090
	S5535-1B-281	281cm	58	9800	10350	10350	10100
	S5535-1B-309	309cm	63.8	10780	11385	11385	11110
	S5535-1B-337	337cm	69.6	11760	12420	12420	12120
	S5535-1B-365	365cm	75.4	12740	13455	13455	13130
	S5535-1B-393	393cm	81.2	13720	14490	14490	14140
	S5535-1B-421	421cm	87	14700	15525	15525	15150
	S5535-1B-449	449cm	92.8	15680	16560	16560	16160

CATEGORY 2A 350mA (2A)	code	length	watt	lumens 3000K	lumens 4000K	lumens 5000K	lumens 6500K
	S5535-2A-57	57cm	23.6	4080	4380	4380	4080
	S5535-2A-85	85cm	35.4	6120	6570	6570	6120
	S5535-2A-113	113cm	47.2	8160	8760	8760	8160
	S5535-2A-141	141cm	59	10200	10950	10950	10200
	S5535-2A-169	169cm	70.8	12240	13140	13140	12240
	S5535-2A-197	197cm	82.6	14280	15330	15330	14280
	S5535-2A-225	225cm	94.4	16320	17520	17520	16320
	S5535-2A-253	253cm	106.2	18360	19710	19710	18360
	S5535-2A-281	281cm	118	20400	21900	21900	20400
	S5535-2A-309	309cm	129.8	22440	24090	24090	22440
	S5535-2A-337	337cm	141.6	24480	26280	26280	24480
	S5535-2A-365	365cm	153.4	26520	28470	28470	26520
	S5535-2A-393	393cm	165.2	28560	30660	30660	28560
	S5535-2A-421	421cm	177	30600	32850	32850	30600
	S5535-2A-449	449cm	188.8	32640	35040	35040	32640

CATEGORY 2B 500mA (2B)	code	length	watt	lumens 3000K	lumens 4000K	lumens 5000K	lumens 6500K
	S5535-2B-57	57cm	35	5700	6140	6140	5700
	S5535-2B-85	85cm	52.5	8550	9210	9210	8550
	S5535-2B-113	113cm	70	11400	12280	12280	11400
	S5535-2B-141	141cm	87.5	14250	15350	15350	14250
	S5535-2B-169	169cm	105	17100	18420	18420	17100
	S5535-2B-197	197cm	122.5	19950	21490	21490	19950
	S5535-2B-225	225cm	140	22800	24560	24560	22800
	S5535-2B-253	253cm	157.5	25650	27630	27630	25650
	S5535-2B-281	281cm	175	28500	30700	30700	28500
	S5535-2B-309	309cm	192.5	31350	33770	33770	31350
	S5535-2B-337	337cm	210	34200	36840	36840	34200
	S5535-2B-365	365cm	227.5	37050	39910	39910	37050
	S5535-2B-393	393cm	245	39900	42980	42980	39900
	S5535-2B-421	421cm	262.5	42750	46050	46050	42750
	S5535-2B-449	449cm	280	45600	49120	49120	45600

S5535 - XX - XXX - X - XX - XX - X - XXX

(a) Κωδικός Γραμμικού Linear Code (b) Κατηγορία Category (c) Μήκος Length (d) Θερμοκρασία φωτός Color Temperature (e) Χρώμα προφίλ Profile color (f) Κάλυμμα Cover (g) Αυξομείωση έντασης φωτός Dimming (h) Τοποθέτηση τροφοδοτικού Power supply installation

Παράδειγμα κωδικού / Code example

LENA 55×35 SUSPENDED 90cm 1A 3000K Black with Diffuser Dimmable (Hidden power supply)
SKU: S5535-1A-90-3-BL-C1-D-PS4

LENA 55×35 SUSPENDED / Manual

3. ΤΟΠΟΘΕΤΗΣΗ ΤΡΟΦΟΔΟΤΙΚΟΥ ΠΑΝΩ ΣΤΟ ΠΡΟΦΙΛ ΜΕ ΡΟΖΕΤΑ / APPLICATION OF POWER SUPPLY ABOVE THE PROFILE IN ROSETTE

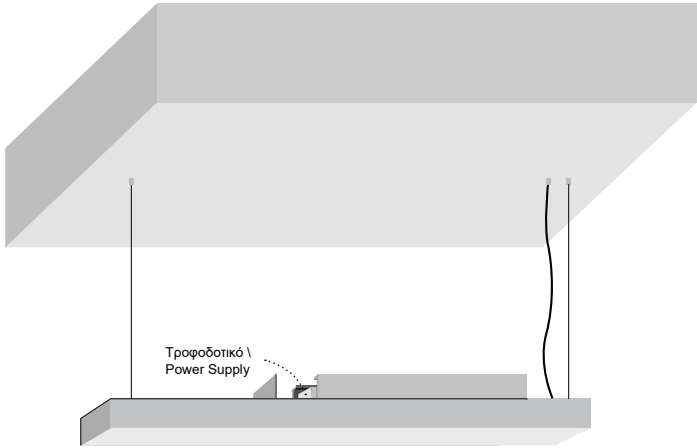

3. ΤΟΠΟΘΕΤΗΣΗ ΤΡΟΦΟΔΟΤΙΚΟΥ ΔΙΠΛΑ ΣΤΟ ΠΡΟΦΙΛ ΜΕ ΡΟΖΕΤΑ / APPLICATION OF POWER SUPPLY TO THE SIDE OF PROFILE IN ROSETTE

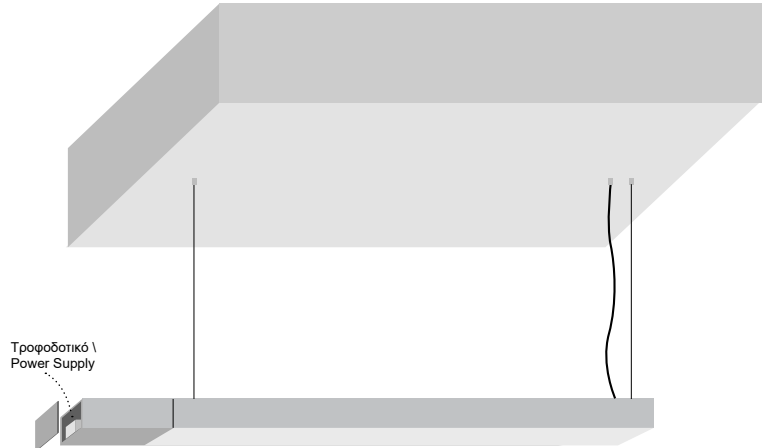

2. ΤΟΠΟΘΕΤΗΣΗ ΤΡΟΦΟΔΟΤΙΚΟΥ ΣΕ ΡΟΖΕΤΑ ΣΤΗΝ ΟΡΟΦΗ / APPLICATION OF POWER SUPPLY IN A ROSETTE ON THE CEILING

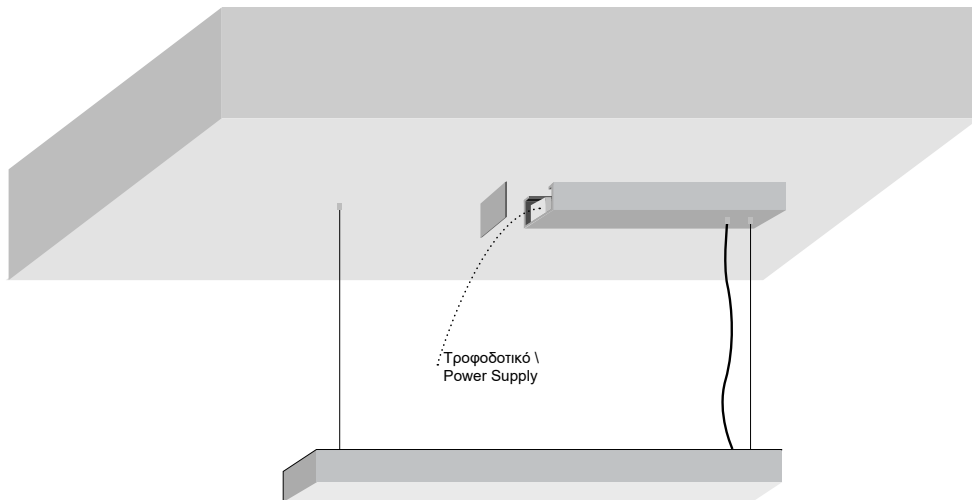

1. ΤΟΠΟΘΕΤΗΣΗ ΜΕ ΤΡΟΦΟΔΟΤΙΚΟ ΠΑΝΩ ΑΠΟ ΤΗ ΓΥΨΟΣΑΝΙΔΑ / APPLICATION WITH POWER SUPPLY ABOVE THE PLASTERBOARD

