

PICCOLO TORCH R18 / Datasheet

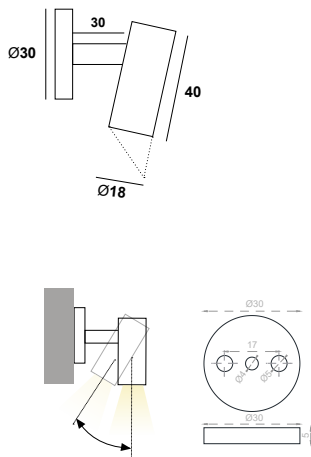

Piccolo Torch 2 R18
Surface mounted
(-2-)



Piccolo Torch 2 R18
Recessed
(-2T-)

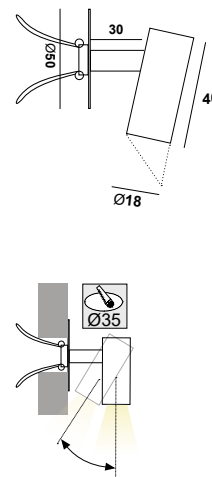

Piccolo Torch 2 R18 Surface
mounted with extension
(-2X__-)

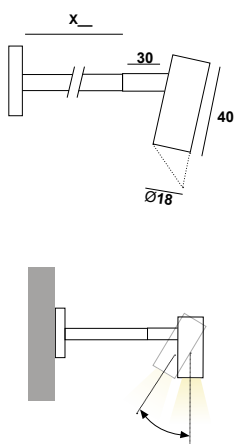

5cm (-X05-)	30cm (-X30-)
10cm (-X10-)	35cm (-X35-)
15cm (-X15-)	40cm (-X40-)
20cm (-X20-)	45cm (-X45-)
25cm (-X25-)	50cm (-X50-)

Piccolo Torch 2 R18
Recessed with extension
(-2X__T-)

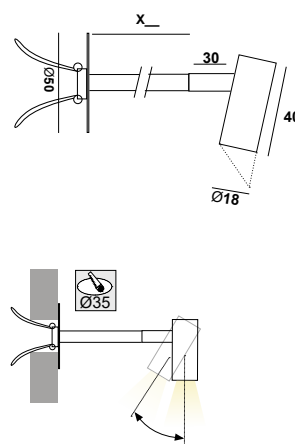

5cm (-X05-)	30cm (-X30-)
10cm (-X10-)	35cm (-X35-)
15cm (-X15-)	40cm (-X40-)
20cm (-X20-)	45cm (-X45-)
25cm (-X25-)	50cm (-X50-)

Piccolo Torch 2 R18 Ring Mounting
(-2R-)

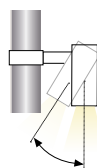
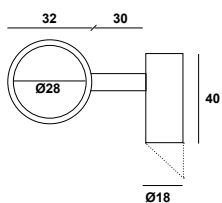

PICCOLO TORCH R18 / Datasheet



Piccolo Torch R18 Surface mounted Vertical on base (-3-)

Piccolo Torch R18 Recessed Vertical on base (-3T-)

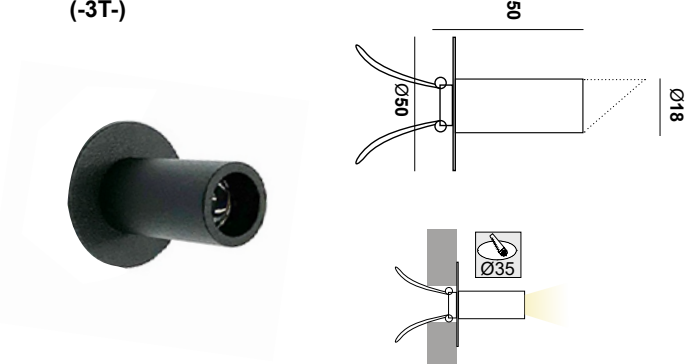
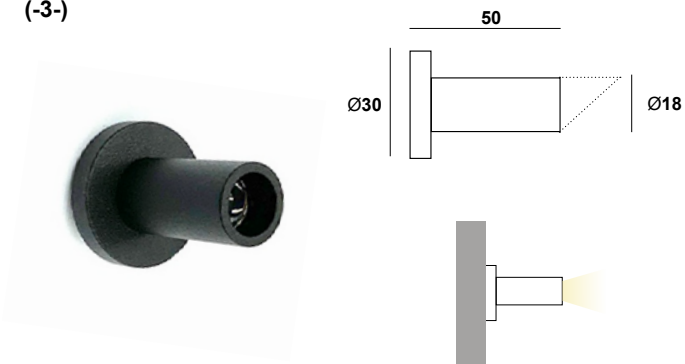

Piccolo Torch R18 Surface mounted Parallel to base (-4-)

Piccolo Torch R18 Recessed Parallel to base (-4T-)

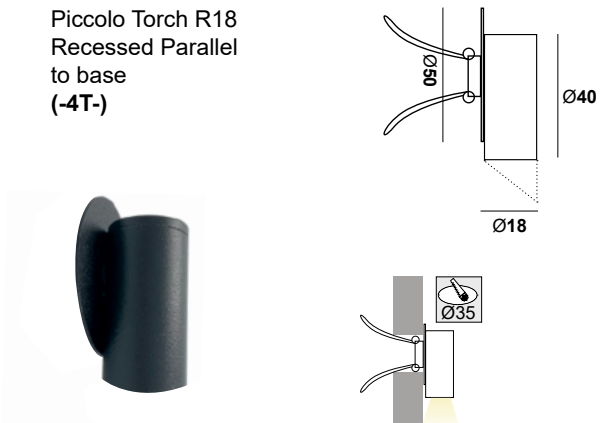
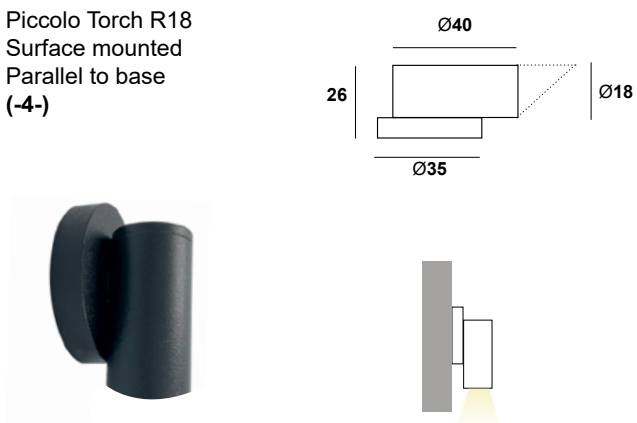

Piccolo Torch R18 Rosette

230 VAC

Μετατρέψτε το Piccolo Torch σε 230VAC, τοποθετώντας το τροφοδοτικό μέσα στη ροζέτα. Turn the Piccolo Torch into 230VAC voltage, placing the power supply in the rosette.

Piccolo Torch 1 R18 Rosette (-1V-)

Piccolo Torch 1 R18 Rosette with extension (-1X__V-)

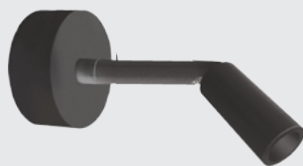
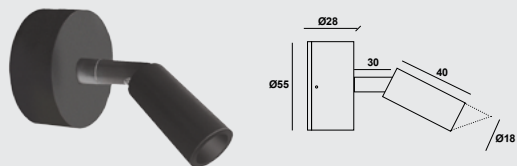

5cm (-X05-)	30cm (-X30-)
10cm (-X10-)	35cm (-X35-)
15cm (-X15-)	40cm (-X40-)
20cm (-X20-)	45cm (-X45-)
25cm (-X25-)	50cm (-X50-)

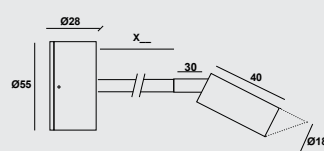

Piccolo Torch 2 R18 Rosette (-2V-)

Piccolo Torch 2 R18 Rosette with extension (-2X__V-)

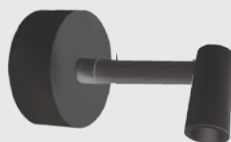



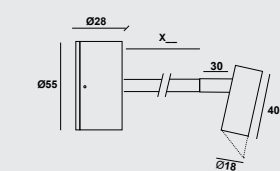



















5cm (-X05-)	30cm (-X30-)
10cm (-X10-)	35cm (-X35-)
15cm (-X15-)	40cm (-X40-)
20cm (-X20-)	45cm (-X45-)
25cm (-X25-)	50cm (-X50-)



PICCOLO TORCH R18 / Code Generator



Warm White (2700-3000K)	110-120 Lm/W
Natural White (4000-5000K)	120-130 Lm/W
Cold White (6000K)	130-140 Lm/W

application	material	color	watt	CCT	CRI	voltage	beam angle	IP	dim
 (1)	 Aluminium (01)	 Black (BL)	1W (1W)	2700K (27K)	Ra80 (80)	12V (V1)	25° (25D)	IP20 (20)	Yes (D)
 (1T)	 INOX (02)	 White (WH)	2.5W (2W)	3000K (30K)	Ra90 (90)	24V (V2)	50° (50D)	IP54 (54)	No (_)
 (1X_)	 Brass (03)	RAL (RL)		4000K (40K)		350mA (1W) (V4)	60° (60D)	IP65 (65)	
 (1X_T)		No color (_)		5000K (50K)			80° (80D)		
 (1R)				6000K (60K)					
 (2)				(R) / (G) (B) / (A)					
 (2T)									
 (2X_)									
 (2X_T)									
 (2R)									
 (3)									
 (3T)									
 (4)									
 (4T)									
 (1V)						230VAC (V3)			
 (1X_V)									
 (2V)									
 (2X_V)									

Δημιουργία Κωδικού προϊόντος / Product Code generator

PC- / PCS- application - material - color - wattage - CCT - CRI - voltage - beam angle - IP - dimmable

(ex. PCS- 2X10T01BL1W30K90V125D20D for Piccolo Torch R18 with Shadow Recessed with extension 10cm Aluminium Black 1W 3000K Ra90 12V 25° IP20 Dimmable)

1.

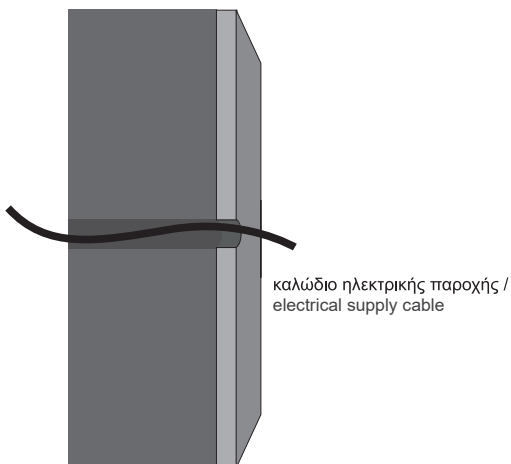

2. Βιδώστε τη βάση του φωτιστικού στον τοίχο. / Screw the base of the luminaire with the electrical supply.

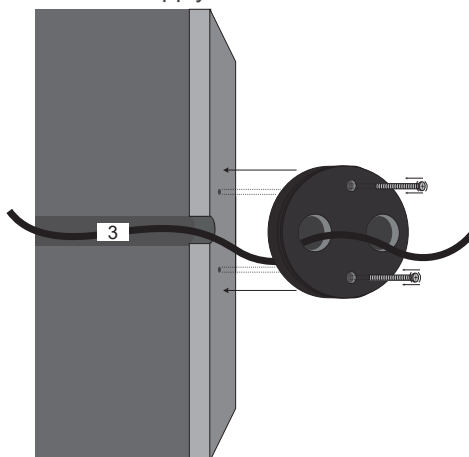

3.

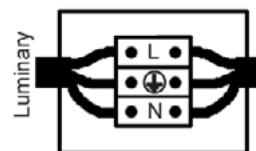

Συνδέστε το καλώδιο του φωτιστικού με την ηλεκτρική παροχή. / Connect the cable of the luminaire with the electrical supply.

4. Τοποθετήστε το φωτιστικό πάνω στη βάση και περιστρέψτε μέχρι να σταθεροποιηθεί. / Place the lamp on the base and rotate until it is fixed.

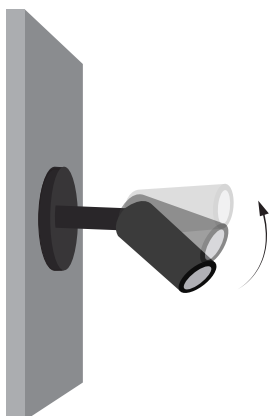
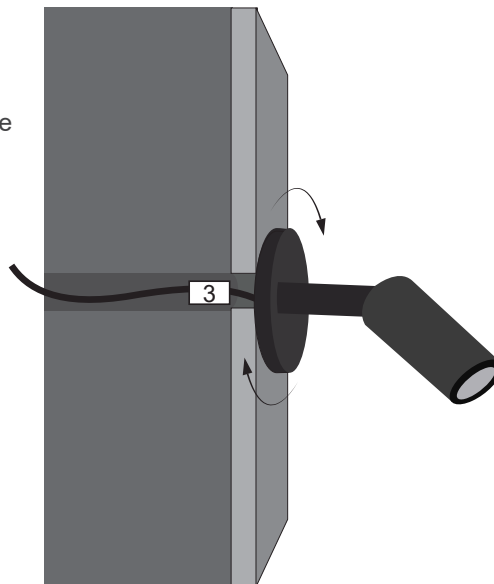
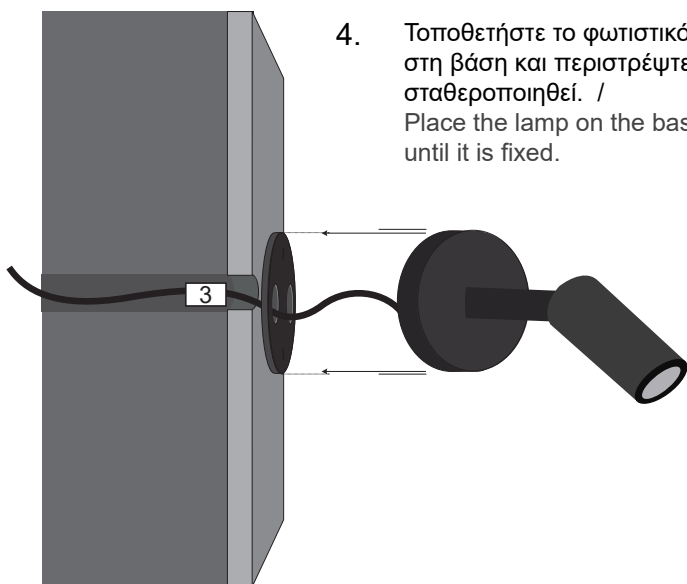

Το φωτιστικό είναι έτοιμο για χρήση. / Luminaire is ready for use