

# 4-ZONE RF REMOTE FOR DIMMER RF TYPE:2.4G

SKU: AC080401-002



4 zone dimming/Touch color wheel/Wireless remote 30m distance/AAAx2 battery

## FEATURES

- Apply to single color LED controller.
- Ultra sensitive color adjustment touch wheel.
- Each remote can match one or more receiver.
- AAAx2 battery powered.
- Operate with LED indicator light.

## Technical Parameters

CE RoHS  LVD RED

Input and Output		Safety and EMC		Environment	
Output signal	RF(2.4GHz)	EMC standard (EMC)	ETSI EN 301 489-1 V2.2.3 ETSI EN 301 489-17 V3.2.4	Operation temperature	Ta: -30 °C ~ +55 °C
Working voltage	3VDC(AAAx2)	Safety standard(LVD)	EN 62368-1:2020+A11:2020	<b>Package</b>	
Working current	<5mA	Radio Equipment(RED)	ETSI EN 300 328 V2.2.2	Size	L140 x W60 x H26mm
Standby current	<10µA	Certification	CE,EMC,LVD,RED	Gross weight	0.088kg
Standby time	1 year			<b>Warranty</b>	
Remote distance	30m(Barrier-free space)			Warranty	5 years

## Mechanical Structures and Installations

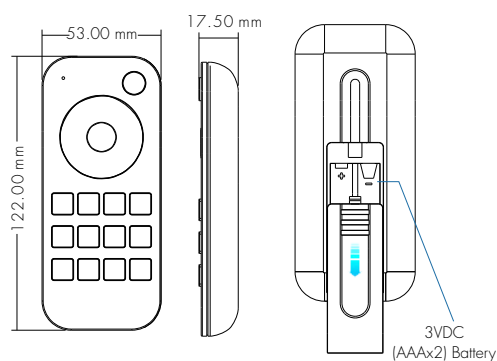

**Back holder** Two options are offered for selection, please fix the back holder on the wall with two screws, or adhere the back holder to the wall with paster.

### 1. Back holder without magnet

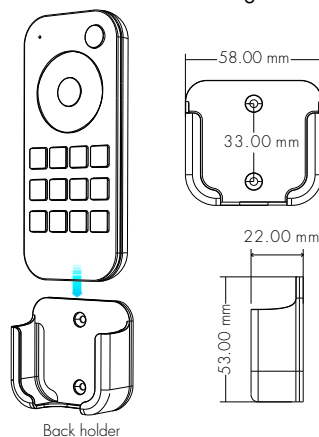

### 2. Back holder with magnet

(The remote with built-in magnet)

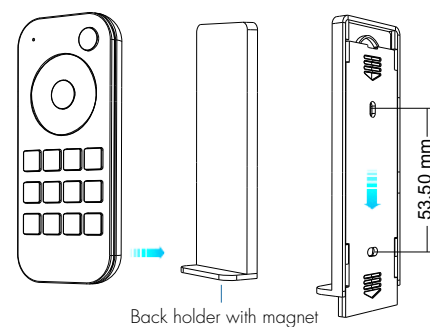

## Operation

- When turn on light, the indicator display blue. when turn off light, the indicator display red.
- When touch the color wheel, the indicator will display the same color.
- When press or touch operation is invalid (If the light is off), the indicator display red.
- To extend battery life, no touch or press key operation after a few seconds, the touch wheel will enter sleep state, you need press any key to make touch wheel quit sleep state.

## TO BE USED WITH



Controller Rf Led Dim Push  
15A-12/24V 10A-36/48V  
SKU: AC080401-001

## 4-ZONE RF REMOTE FOR DIMMER RF TYPE:2.4G

### Match Remote Control (two match ways)

End user can choose the suitable match/delete ways. Two options are offered for selection:

#### Use the controller's Match key

Match:

Short press match key, immediately press on/off key (single zone remote) or zone key (multiple zone remote) of the remote.

The LED indicator fast flash a few times means match is successful.

Delete:

Press and hold match key for 5s to delete all match,

The LED indicator fast flash a few times means all matched remotes were deleted.

#### Use Power Restart

Match:

Switch off the power, then switch on power, repeat again.

Immediately short press on/off key (single zone remote) or zone key (multiple zone remote) 3 times on the remote.

The light blinks 3 times means match is successful.

Delete:

Switch off the power, then switch on power, repeat again.

Immediately short press on/off key (single zone remote) or zone key (multiple zone remote) 5 times on the remote.

The light blinks 5 times means all matched remotes were deleted.

### Key function

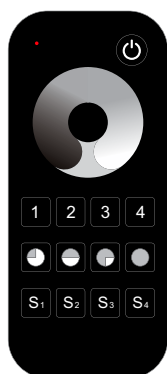

 : Short press turn on/off all zone light.

 : Touch to change current zone brightness.

 : Short press select and turn on zone light, long press 2s turn off zone light.  
Short press multiple zone key fastly, will select multiple zone synchronously.

 : 25%, 50%, 75%, 100% brightness for current selected zone.

 : Short press recall the scene, long press 2s save current state into S1/2/3/4.  
the LED indicator display green when save OK.  
4 zone recall or save synchronously.

The remote can be used as 4 zone dimming remote or single zone 4 channel dimming remote.

**On/Off + 4:** Long press 2s set as 4 channel dimming remote, only match with one or multiple receiver of 4 channel, such as V4 or C4 controller.

**On/Off + 1:** Long press 2s set as 4 zone dimming remote, each zone match with one or multiple receivers.

When set ok, the green indicator will light on longer.

### Safety information

1. Read all instructions carefully before you begin this installation.
2. When installing battery, pay attention to the battery positive and negative polarity.  
A long time without the remote control, remove the battery.  
When remote distance becomes smaller and insensitive, replace the battery.
3. If no response from the receiver, please re-match the remote.
4. Gently handle remote, beware of falling.
5. For indoor and dry location use only.