

60W Single Output DALI+PUSH Dimming Power



- **Features :**
- Constant voltage output design.
- 200~240 AC input.
- Encapsulated with IP20 level.
- Withstand 300VAC surge input for 5 seconds.
- Protections: Short circuit/Overload/Over voltage.
- Cooling by free air convection.
- DALI+PUSH dimming option.
- 100% full load burn-in test.
- High cost-performance, high reliability.
- Suitable for LED related fixture or appliance.

IP20 CE 

SPECIFICATION

MODEL		DP-60D-12	DP-60D-24	
OUTPUT	DC VOLTAGE	12V	24V	
	RATED CURRENT	5.0A	2.5A	
	CURRENT RANGE	0 ~ 5.0A	0 ~ 2.5A	
	RATED POWER	60W	60W	
	RIPPLE & NOISE	120mVp-p	150mVp-p	
	VOLTAGE TOLERANCE	±5.0%	±5.0%	
	LINE REGULATION	±0.5%		
	LOAD REGULATION	±1.0%	±1.0%	
	SETUP, RISE TIME	500ms, 30ms / 230VAC		500ms
HOLD UP TIME	30ms/230VAC at full load			
INPUT	VOLTAGE RANGE	200 ~ 240VAC		
	FREQUENCY RANGE	47 ~ 63Hz		
	EFFICIENCY	82%	83%	
	AC CURRENT	0.5A/230VAC		
	INRUSH CURRENT	COLD START 40A at 230VAC		
	LEAKAGE CURRENT	<2.0mA / 240VAC		
PROTECTION	OVERLOAD	110 ~ 150% rated output power Hiccup mode, recovers automatically after fault condition is removed		
	OVER VOLTAGE	Shut down o/p voltage, re-power on to recover		
ENVIRONMENT	WORKING TEMP.	-10°C ~ +45°C		
	WORKING HUMIDITY	20 ~ 90% RH non-condensing		
	STORAGE TEMP., HUMIDITY	-20 ~ +80°C, 10 ~ 95% RH		
	TEMP. COEFFICIENT	±0.03%/°C (0 ~ 50°C)		
SAFETY	SAFETY STANDARDS	EN IEC 55015:2019, EN IEC 61000-3-2:2019+A1:2021, EN 61000-3-3:2013+A2:2021+AC:2022-01		
	WITHSTAND VOLTAGE	I/P-O/P:1.5KVAC I/P-FG:1.5KVAC O/P-FG:0.5KVAC		
	ISOLATION RESISTANCE	I/P-O/P,I/P-FG,O/P-FG:100M ohms/500VDC		
OTHERS	DIMMING OPTIONS	DALI+PUSH		
	DIMENSION	187*48*29 MM (L*W*H)		
	PACKING	0.21KG/PCS		

Switching Time Curve:

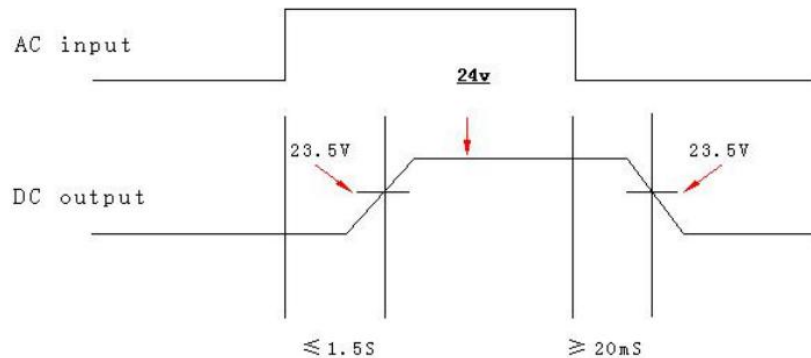

I. About this LED power supply (LED driver, switching power supply)

This LED power supply is mainly consisted of five parts:

- 1) Electromagnetic Interference network
- 2) Rectifier filter
- 3) Built-in Pulse Width Modulation unit
- 4) Switch for energy transform
- 5) Low ESR Pulse Width Modulation output devices

Our high efficiency LED power supply provides you stable power output with stable current, 100% burn-in tested, and interference of fluctuation from input current which is benefit for the life span of LED appliances.

II. Product Features

- 1) Over-load / over-current / short circuit protection
- 2) Please be advised to use the driver no more than 80% of full loading according to standard use
- 3) Comply with international power consumption standard of *stand by* status
- 4) Input electric current surge resisting (5 seconds under 300VAC input)
- 5) Choose 105°C electrolytic capacitor,suitable for tough work condition
- 6) High working efficiency, energy saving
- 7) Compact size and easy installation
- 8) Waterproof types are suitable for outdoor use, waterproof rate: IP65/IP67

III. Installation and working environments

- 1) The input voltage must fall into 200~240VAC, 50/60HZ
- 2) Do not overload, also avoid free of load while a power supply is powered on, keep proper loading
- 3) Always keep good ventilation as below indicated



- 4) NO wood or flammable surface mounting, keep min. 5CM for power supplies each other

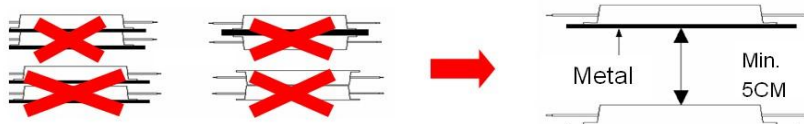

- 5) Keep away from inflammable or explosive environments
- 6)

60W Single Output DALI+PUSH Dimming Power Supply

IV. Wire Connection

Waterproof types:

AC Input: yellow/green lead is for grounding, rest leads are for electricity

DC Output: Red (brown) LED+, black (blue) LED-

Signal output: Red positive + for D+, black negative - for D-

Non-waterproof types:

Make sure wires are well connected, most of our models have multi-outlets, we recommend the following loading order: negative – positive- negative- positive- negative....etc. Please always keep balanced loading.

Cautions for Connecting Leads and Loading

- 1) The power supply will be automatically protected and enter the abnormal state of intermittent connection if the load power exceeds the maximal rated output power (normally 5~20% exceeds).
- 2) **For models have multi-outlets, never connect all loading with single outlet, please keep balanced loading. If connecting with only single outlet is necessary, please connect all positive output leads together to provide electricity fully, also negative leads.**
- 3) Please be well noticed that too long connecting leads will cause to line loss. So please avoid too long extension with output leads.
- 4) Input/output lead's surface listed its diameter and industrial standard, please choose proper extension leads accordingly. In view of the line loss, the longer extension, the stronger leads is needed.
- 5) This power supply can be connected with plugs, but please make it well connected and insulated.

The installation and wire connection of this power supply should be conducted by qualified technicians!

DALI+PUSH Diagram:

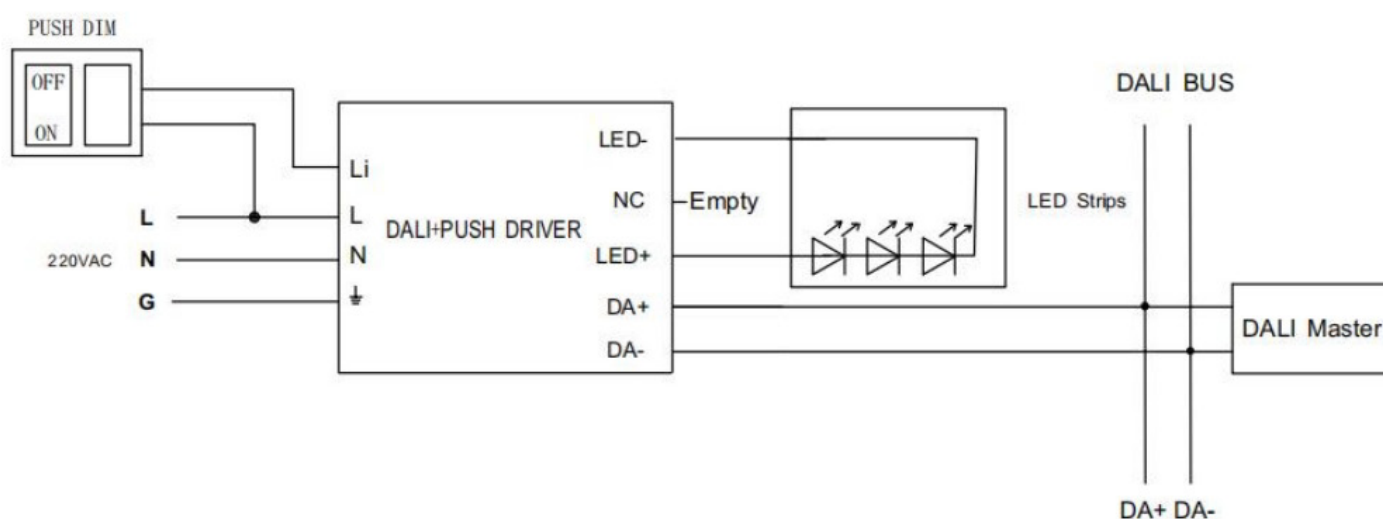

LED POWER SUPPLY Trouble-shooting Tips

There is a protection circuit in the Power Supply that will cut off (trip) the power whenever an short circuit or overload condition occurs, please make sure correct connection of positive and negative terminals(+, -) before power on.

1. Power Supply does not work:

- 1) Check the input power voltage.
- 2) Check power on/off status.
- 3) Check if there's short-circuit on output line.
- 4) Check if wrong positive and negative terminal connection.
- 5) Check if the output indication light is lighting (for the models which have this function).
- 6) Check if the fuse well connected (for the non-sealed models).

2. Over-heated of the Power Supply:

- 1) Keep good ventilation.
- 2) Check the loading status, avoid over loading.

3. Unsteady power output:

- 1) Check if there's over-loading or improper output extension leads connected.
- 2) Check if there's strong interference in the working environment.
- 3) Check if there's magnetic field around the working environment.

4. LED light works dark (weak light, LED not bright enough)

- 1) Please check if the output voltage is good for your requirement(5V/12V/24V...etc.).
- 2) Choose proper wires in aspects of wire's diameter and voltage capacity.
- 3) Check if there's over-load or too long extension leads been used.

V. Working environment:

- 1)Outdoor types: -10℃ ~+45℃ , Relative Humidity: 100%
- 2)Indoor type: -10℃ ~+45℃ , Relative Humidity: under 90%
- 3)Storage environment: -20℃ ~+80℃ , Relative Humidity: under 95%