



CATALOG 2024

LINEAR LIGHTING SYSTEMS

ΓΡΑΜΜΙΚΑ ΣΥΣΤΗΜΑΤΑ



light. our passion is



**Έκθεση:** Ελ. Βενιζέλου και Βύρωνος, 26333 Πάτρα  
**Βιοτεχνία:** Γλαύκου 83, 26332 Πάτρα



2610 317 313  
2610 317 300



barislight.eu  
b2b.barislight.eu



info@barislight.eu



Baris Light

# Linear lighting systems

ΠΕΡΙΕΧΟΜΕΝΑ / CONTENTS

## χωνευτά / recessed

linear 30×15mm trimless



gila 35×35 trimless



lena 55×35 trimless



dark lena 55×35 trimless



nile 55×80 recessed



dark nile 55×80 recessed



## επίτοιχα / surface mounted

gila 35×35



lena 55×35



dark lena 55×35



ganges 55×60



linear 55×70



dark linear 55×70



nile 55×80



## κρεμαστά / suspended

gila 35×35  
suspended



lena 55×35  
suspended



dark lena 55×35  
suspended



ganges 55×60  
suspended



linear 55×70  
suspended



pg. 68

dark linear 55×70  
suspended



pg. 71

nile 55×80  
suspended



pg. 74

## Updown

linear updown 55×70



pg. 80

dark linear updown 55×70



pg. 84

## κύκλοι / circles

circle 55×100  
trimless



pg. 90

circle 55×100



pg. 94

circle 55×100  
suspended



pg. 98

## Ειδικές κατασκευές / Special constructions

Καμπύλες / Curves

pg. 102

Συνδυασμός Diffuse - Dark / Diffuse - Dark combination

pg. 106

Πλακέτες Tunable 2700K-6500K / Tunable 2700K-6500K modules

pg. 108

**Blu2Light®** wireless light management system

pg. 110

Εγγύηση / Warranty

pg. 112

Σήμανση καταλόγου / Catalogue indication

pg. 114





XΩNEYTA / RECESSED

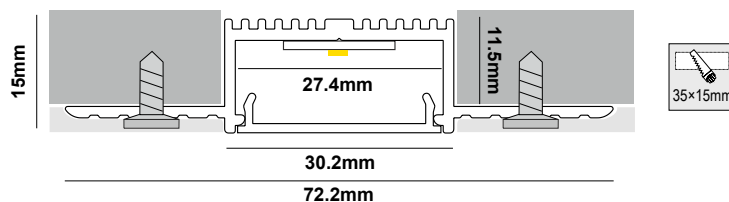

T3015 - XX - XXX - X - X

- (a)  
Κωδικός Γραμμικού  
Linear Code
- (b)  
Κατηγορία  
Category
- (c)  
Μήκος  
Length
- (d)  
CCT
- (f)  
Αυξομείωση  
έντασης φωτός  
Dimming

Παράδειγμα κωδικού / Code example

LINEAR 30×15 TRIMLESS 1A 85cm 3000K Dimmable  
SKU: T3015-1A-85-3-D

| material           | pcb details                | CRI                      | lumen output / W |
|--------------------|----------------------------|--------------------------|------------------|
| Extruded aluminium | Zhaga-Compliant Dimensions | Ra>80 (Ra>90 on request) | up to 195 Lm/W   |

| covers   | CCT                        | dimming options (D) |
|--|----------------------------|---------------------|
| <p>Click diffuser 1.5mm<br/>( up to 70m reel )</p> | 3000K (3)                  | Push                |
|  | 4000K (4)                  | DALI                |
|  | 5000K (5)                  | TRIAC 0/1-10V       |
|  | 6500K (6)                  | CASAMBI             |
|  | TUNABLE 2700K - 6500K (TN) | Analog 0/1-10V      |



RECESSED TRIMLESS



## LINEAR 30×15 TRIMLESS / Lumen output tables

| CATEGORY 1A 350mA (1A) | code         | length | watt  | lumens 3000K | lumens 4000K | lumens 5000K | lumens 6500K |
|------------------------|--------------|--------|-------|--------------|--------------|--------------|--------------|
|                        | T3015-1A-57  | 57cm   | 7.8   | 1390         | 1470         | 1470         | 1440         |
|                        | T3015-1A-85  | 85cm   | 11.7  | 2085         | 2205         | 2205         | 2160         |
|                        | T3015-1A-113 | 113cm  | 15.6  | 2780         | 2940         | 2940         | 2880         |
|                        | T3015-1A-141 | 141cm  | 19.5  | 3475         | 3675         | 3675         | 3600         |
|                        | T3015-1A-169 | 57cm   | 23.4  | 4170         | 4410         | 4410         | 4320         |
|                        | T3015-1A-197 | 85cm   | 27.3  | 4865         | 5145         | 5145         | 5040         |
|                        | T3015-1A-225 | 113cm  | 31.2  | 5560         | 5880         | 5880         | 5760         |
|                        | T3015-1A-253 | 141cm  | 35.1  | 6255         | 6615         | 6615         | 6480         |
|                        | T3015-1A-281 | 281cm  | 39    | 6950         | 7350         | 7350         | 7200         |
|                        | T3015-1A-309 | 309cm  | 42.9  | 7645         | 8085         | 8085         | 7920         |
|                        | T3015-1A-337 | 337cm  | 46.8  | 8340         | 8820         | 8820         | 8640         |
|                        | T3015-1A-365 | 365cm  | 50.7  | 9035         | 9555         | 9555         | 9360         |
|                        | T3015-1A-393 | 393cm  | 54.6  | 9730         | 10290        | 10290        | 10080        |
|                        | T3015-1A-421 | 421cm  | 58.5  | 10425        | 11025        | 11025        | 10800        |
| T3015-1A-449           | 449cm        | 62.4   | 11120 | 11760        | 11760        | 11520        |              |

wattage: 13.5 W/m

| CATEGORY 1B 500mA (1B) | T3015-1B-57  | 57cm  | 11.6 | 1960  | 2070  | 2070  | 2020  |
|------------------------|--------------|-------|------|-------|-------|-------|-------|
|                        | T3015-1B-85  | 85cm  | 17.4 | 2940  | 3105  | 3105  | 3030  |
|                        | T3015-1B-113 | 113cm | 23.2 | 3920  | 4140  | 4140  | 4040  |
|                        | T3015-1B-141 | 141cm | 29   | 4900  | 5175  | 5175  | 5050  |
|                        | T3015-1B-169 | 169cm | 34.8 | 5880  | 6210  | 6210  | 6060  |
|                        | T3015-1B-197 | 197cm | 40.6 | 6860  | 7245  | 7245  | 7070  |
|                        | T3015-1B-225 | 225cm | 46.4 | 7840  | 8280  | 8280  | 8080  |
|                        | T3015-1B-253 | 253cm | 52.2 | 8820  | 9315  | 9315  | 9090  |
|                        | T3015-1B-281 | 281cm | 58   | 9800  | 10350 | 10350 | 10100 |
|                        | T3015-1B-309 | 309cm | 63.8 | 10780 | 11385 | 11385 | 11110 |
|                        | T3015-1B-337 | 337cm | 69.6 | 11760 | 12420 | 12420 | 12120 |
|                        | T3015-1B-365 | 365cm | 75.4 | 12740 | 13455 | 13455 | 13130 |
|                        | T3015-1B-393 | 393cm | 81.2 | 13720 | 14490 | 14490 | 14140 |
|                        | T3015-1B-421 | 421cm | 87   | 14700 | 15525 | 15525 | 15150 |
|                        | T3015-1B-449 | 449cm | 92.8 | 15680 | 16560 | 16560 | 16160 |

wattage: 20 W/m

Το φωτιστικό είναι διαθέσιμο σε μήκος πολλαπλάσιο των 14 εκατοστών

The illuminant is available in lengths that are multiples of 14 centimeters.

## LINEAR 30×15 TRIMLESS / Lumen output tables

| CATEGORY 2A 350mA (2A) | code         | length | watt  | lumens 3000K | lumens 4000K | lumens 5000K | lumens 6500K |
|------------------------|--------------|--------|-------|--------------|--------------|--------------|--------------|
|                        | T3015-2A-57  | 57cm   | 23.6  | 4080         | 4380         | 4380         | 4080         |
|                        | T3015-2A-85  | 85cm   | 35.4  | 6120         | 6570         | 6570         | 6120         |
|                        | T3015-2A-113 | 113cm  | 47.2  | 8160         | 8760         | 8760         | 8160         |
|                        | T3015-2A-141 | 141cm  | 59    | 10200        | 10950        | 10950        | 10200        |
|                        | T3015-2A-169 | 169cm  | 70.8  | 12240        | 13140        | 13140        | 12240        |
|                        | T3015-2A-197 | 197cm  | 82.6  | 14280        | 15330        | 15330        | 14280        |
|                        | T3015-2A-225 | 225cm  | 94.4  | 16320        | 17520        | 17520        | 16320        |
|                        | T3015-2A-253 | 253cm  | 106.2 | 18360        | 19710        | 19710        | 18360        |
|                        | T3015-2A-281 | 281cm  | 118   | 20400        | 21900        | 21900        | 20400        |
|                        | T3015-2A-309 | 309cm  | 129.8 | 22440        | 24090        | 24090        | 22440        |
|                        | T3015-2A-337 | 337cm  | 141.6 | 24480        | 26280        | 26280        | 24480        |
|                        | T3015-2A-365 | 365cm  | 153.4 | 26520        | 28470        | 28470        | 26520        |
|                        | T3015-2A-393 | 393cm  | 165.2 | 28560        | 30660        | 30660        | 28560        |
|                        | T3015-2A-421 | 421cm  | 177   | 30600        | 32850        | 32850        | 30600        |
| T3015-2A-449           | 449cm        | 188.8  | 32640 | 35040        | 35040        | 32640        |              |

wattage: 40.5 W/m

|              |       |       |       |       |       |       |
|--------------|-------|-------|-------|-------|-------|-------|
| T3015-2B-57  | 57cm  | 35    | 5700  | 6140  | 6140  | 5700  |
| T3015-2B-85  | 85cm  | 52.5  | 8550  | 9210  | 9210  | 8550  |
| T3015-2B-113 | 113cm | 70    | 11400 | 12280 | 12280 | 11400 |
| T3015-2B-141 | 141cm | 87.5  | 14250 | 15350 | 15350 | 14250 |
| T3015-2B-169 | 169cm | 105   | 17100 | 18420 | 18420 | 17100 |
| T3015-2B-197 | 197cm | 122.5 | 19950 | 21490 | 21490 | 19950 |
| T3015-2B-225 | 225cm | 140   | 22800 | 24560 | 24560 | 22800 |
| T3015-2B-253 | 253cm | 157.5 | 25650 | 27630 | 27630 | 25650 |
| T3015-2B-281 | 281cm | 175   | 28500 | 30700 | 30700 | 28500 |
| T3015-2B-309 | 309cm | 192.5 | 31350 | 33770 | 33770 | 31350 |
| T3015-2B-337 | 337cm | 210   | 34200 | 36840 | 36840 | 34200 |
| T3015-2B-365 | 365cm | 227.5 | 37050 | 39910 | 39910 | 37050 |
| T3015-2B-393 | 393cm | 245   | 39900 | 42980 | 42980 | 39900 |
| T3015-2B-421 | 421cm | 262.5 | 42750 | 46050 | 46050 | 42750 |
| T3015-2B-449 | 449cm | 280   | 45600 | 49120 | 49120 | 45600 |

wattage: 60.5 W/m

Το φωτιστικό είναι διαθέσιμο σε μήκος πολλαπλάσιο των 14 εκατοστών

The illuminant is available in lengths that are multiples of 14 centimeters.



**(-M-)**  
 χωνευτή τοποθέτηση με  
 γωνιόκρανο αλουμινίου  
 Trimless Installation with  
 aluminium angular

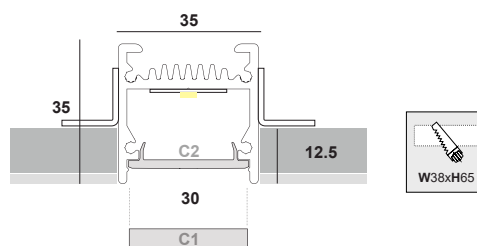

**(-P-)**  
 χωνευτή τοποθέτηση με  
 πλαστικό γωνιόκρανο  
 Trimless Installation with  
 plastic angular

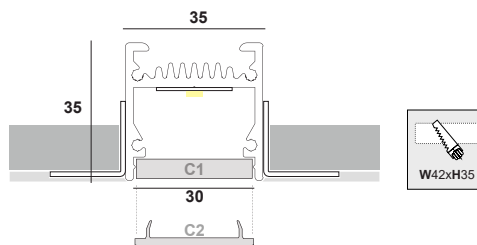

# T35 - XX - XXX - X - XX - X - X

| (a)                              | (b)                   | (c)             | (d)  | (e)              | (f)                                    | (g)   |
|----------------------------------|-----------------------|-----------------|--|------------------|--|---|
| Κωδικός Γραμμικού<br>Linear Code | Κατηγορία<br>Category | Μήκος<br>Length | Θερμοκρασία<br>φωτός<br>Color<br>Temperature | Κάλυμμα<br>Cover | Αυξομείωση<br>έντασης φωτός<br>Dimming | Χωνευτή<br>τοποθέτηση<br>Trimless<br>installation |

## Παράδειγμα κωδικού / Code example

GILA 35x35 TRIMLESS 1A 87cm 3000K Diffuser 1.5m Dimmable with Plastic Angular  
 SKU: T35-1A-87-3-C2-D-P

| material           | pcb details                | CRI                                 | lumen output / W |
|--------------------|----------------------------|-------------------------------------|------------------|
| Extruded aluminium | Zhaga-Compliant Dimensions | Ra>80 ( <b>Ra&gt;90</b> on request) | up to 195 Lm/W   |

| covers   | CCT                        | dimming options (D) |
|--|----------------------------|---------------------|
| Slide Diffuser 5mm<br>(-C1-)                         | 3000K (3)                  | Push                |
|  | 4000K (4)                  | DALI                |
| Click diffuser 1.5mm<br>( up to 70m reel )<br>(-C2-) | 5000K (5)                  | TRIAC 0/1-10V       |
|  | 6500K (6)                  | CASAMBI             |
|  | TUNABLE 2700K - 6500K (TN) | Analog 0/1-10V      |



RECESSED TRIMLESS

## GILA 35×35 TRIMLESS / Lumen output tables

| CATEGORY 1A 350mA (1A) | code       | length | watt  | lumens 3000K | lumens 4000K | lumens 5000K | lumens 6500K |
|------------------------|------------|--------|-------|--------------|--------------|--------------|--------------|
|                        | T35-1A-59  | 59cm   | 7.8   | 1390         | 1470         | 1470         | 1440         |
|                        | T35-1A-87  | 87cm   | 11.7  | 2085         | 2205         | 2205         | 2160         |
|                        | T35-1A-115 | 115cm  | 15.6  | 2780         | 2940         | 2940         | 2880         |
|                        | T35-1A-143 | 143cm  | 19.5  | 3475         | 3675         | 3675         | 3600         |
|                        | T35-1A-171 | 171cm  | 23.4  | 4170         | 4410         | 4410         | 4320         |
|                        | T35-1A-199 | 199cm  | 27.3  | 4865         | 5145         | 5145         | 5040         |
|                        | T35-1A-227 | 227cm  | 31.2  | 5560         | 5880         | 5880         | 5760         |
|                        | T35-1A-255 | 255cm  | 35.1  | 6255         | 6615         | 6615         | 6480         |
|                        | T35-1A-283 | 283cm  | 39    | 6950         | 7350         | 7350         | 7200         |
|                        | T35-1A-311 | 311cm  | 42.9  | 7645         | 8085         | 8085         | 7920         |
|                        | T35-1A-339 | 339cm  | 46.8  | 8340         | 8820         | 8820         | 8640         |
|                        | T35-1A-367 | 367cm  | 50.7  | 9035         | 9555         | 9555         | 9360         |
|                        | T35-1A-395 | 395cm  | 54.6  | 9730         | 10290        | 10290        | 10080        |
|                        | T35-1A-423 | 423cm  | 58.5  | 10425        | 11025        | 11025        | 10800        |
| T35-1A-451             | 451cm      | 62.4   | 11120 | 11760        | 11760        | 11520        |              |

wattage: 13.5 W/m

| CATEGORY 1B 500mA (1B) | T35-1B-59  | 59cm  | 11.6 | 1960  | 2070  | 2070  | 2020  |
|------------------------|------------|-------|------|-------|-------|-------|-------|
|                        | T35-1B-87  | 87cm  | 17.4 | 2940  | 3105  | 3105  | 3030  |
|                        | T35-1B-115 | 115cm | 23.2 | 3920  | 4140  | 4140  | 4040  |
|                        | T35-1B-143 | 143cm | 29   | 4900  | 5175  | 5175  | 5050  |
|                        | T35-1B-171 | 171cm | 34.8 | 5880  | 6210  | 6210  | 6060  |
|                        | T35-1B-199 | 199cm | 40.6 | 6860  | 7245  | 7245  | 7070  |
|                        | T35-1B-227 | 227cm | 46.4 | 7840  | 8280  | 8280  | 8080  |
|                        | T35-1B-255 | 255cm | 52.2 | 8820  | 9315  | 9315  | 9090  |
|                        | T35-1B-283 | 283cm | 58   | 9800  | 10350 | 10350 | 10100 |
|                        | T35-1B-311 | 311cm | 63.8 | 10780 | 11385 | 11385 | 11110 |
|                        | T35-1B-339 | 339cm | 69.6 | 11760 | 12420 | 12420 | 12120 |
|                        | T35-1B-367 | 367cm | 75.4 | 12740 | 13455 | 13455 | 13130 |
|                        | T35-1B-395 | 395cm | 81.2 | 13720 | 14490 | 14490 | 14140 |
|                        | T35-1B-423 | 423cm | 87   | 14700 | 15525 | 15525 | 15150 |
|                        | T35-1B-451 | 451cm | 92.8 | 15680 | 16560 | 16560 | 16160 |

wattage: 20 W/m

Το φωτιστικό είναι διαθέσιμο σε μήκος πολλαπλάσιο των 14 εκατοστών

The illuminant is available in lengths that are multiples of 14 centimeters.

## GILA 35×35 TRIMLESS / Lumen output tables

| CATEGORY 2A 350mA (2A) | code       | length | watt  | lumens 3000K | lumens 4000K | lumens 5000K | lumens 6500K |
|------------------------|------------|--------|-------|--------------|--------------|--------------|--------------|
|                        | T35-2A-59  | 59cm   | 23.6  | 4080         | 4380         | 4380         | 4080         |
|                        | T35-2A-87  | 87cm   | 35.4  | 6120         | 6570         | 6570         | 6120         |
|                        | T35-2A-115 | 115cm  | 47.2  | 8160         | 8760         | 8760         | 8160         |
|                        | T35-2A-143 | 143cm  | 59    | 10200        | 10950        | 10950        | 10200        |
|                        | T35-2A-171 | 171cm  | 70.8  | 12240        | 13140        | 13140        | 12240        |
|                        | T35-2A-199 | 199cm  | 82.6  | 14280        | 15330        | 15330        | 14280        |
|                        | T35-2A-227 | 227cm  | 94.4  | 16320        | 17520        | 17520        | 16320        |
|                        | T35-2A-255 | 255cm  | 106.2 | 18360        | 19710        | 19710        | 18360        |
|                        | T35-2A-283 | 283cm  | 118   | 20400        | 21900        | 21900        | 20400        |
|                        | T35-2A-311 | 311cm  | 129.8 | 22440        | 24090        | 24090        | 22440        |
|                        | T35-2A-339 | 339cm  | 141.6 | 24480        | 26280        | 26280        | 24480        |
|                        | T35-2A-367 | 367cm  | 153.4 | 26520        | 28470        | 28470        | 26520        |
|                        | T35-2A-395 | 395cm  | 165.2 | 28560        | 30660        | 30660        | 28560        |
| T35-2A-423             | 423cm      | 177    | 30600 | 32850        | 32850        | 30600        |              |
| T35-2A-451             | 451cm      | 188.8  | 32640 | 35040        | 35040        | 32640        |              |

wattage: 40.5 W/m

| CATEGORY 2B 500mA (2B) | code       | length | watt  | lumens 3000K | lumens 4000K | lumens 5000K | lumens 6500K |
|------------------------|------------|--------|-------|--------------|--------------|--------------|--------------|
|                        | T35-2B-59  | 59cm   | 35    | 5700         | 6140         | 6140         | 5700         |
|                        | T35-2B-87  | 87cm   | 52.5  | 8550         | 9210         | 9210         | 8550         |
|                        | T35-2B-115 | 115cm  | 70    | 11400        | 12280        | 12280        | 11400        |
|                        | T35-2B-143 | 143cm  | 87.5  | 14250        | 15350        | 15350        | 14250        |
|                        | T35-2B-171 | 171cm  | 105   | 17100        | 18420        | 18420        | 17100        |
|                        | T35-2B-199 | 199cm  | 122.5 | 19950        | 21490        | 21490        | 19950        |
|                        | T35-2B-227 | 227cm  | 140   | 22800        | 24560        | 24560        | 22800        |
|                        | T35-2B-255 | 255cm  | 157.5 | 25650        | 27630        | 27630        | 25650        |
|                        | T35-2B-283 | 283cm  | 175   | 28500        | 30700        | 30700        | 28500        |
|                        | T35-2B-311 | 311cm  | 192.5 | 31350        | 33770        | 33770        | 31350        |
|                        | T35-2B-339 | 339cm  | 210   | 34200        | 36840        | 36840        | 34200        |
|                        | T35-2B-367 | 367cm  | 227.5 | 37050        | 39910        | 39910        | 37050        |
|                        | T35-2B-395 | 395cm  | 245   | 39900        | 42980        | 42980        | 39900        |
| T35-2B-423             | 423cm      | 262.5  | 42750 | 46050        | 46050        | 42750        |              |
| T35-2B-451             | 451cm      | 280    | 45600 | 49120        | 49120        | 45600        |              |

wattage: 60.5 W/m

Το φωτιστικό είναι διαθέσιμο σε μήκος πολλαπλάσιο των 14 εκατοστών

The illuminant is available in lengths that are multiples of 14 centimeters.

LENA 55x35 TRIMLESS (T5535-)



**(-M-)**  
 χωνευτή τοποθέτηση με  
 γωνιόκρανο αλουμινίου  
 Trimless Installation with  
 aluminium angular

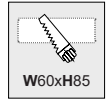
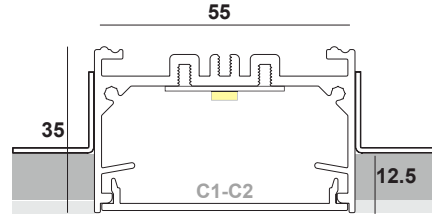

**(-P-)**  
 χωνευτή τοποθέτηση με  
 πλαστικό γωνιόκρανο  
 Trimless Installation with  
 plastic angular

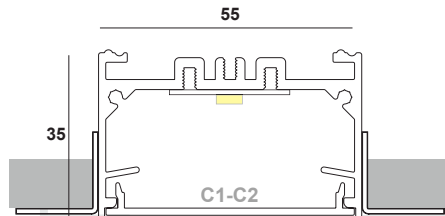



T5535 - XX - XXX - X - XX - X - X

|                                  |                       |                 |  |                  |  |   |
|----------------------------------|-----------------------|-----------------|--|------------------|--|---|
| (a)                              | (b)                   | (c)             | (d)  | (e)              | (f)                                    | (g)   |
| Κωδικός Γραμμικού<br>Linear Code | Κατηγορία<br>Category | Μήκος<br>Length | Θερμοκρασία<br>φωτός<br>Color<br>Temperature | Κάλυμμα<br>Cover | Αυξομείωση<br>έντασης φωτός<br>Dimming | Χωνευτή<br>τοποθέτηση<br>Trimless<br>installation |

**Παράδειγμα κωδικού / Code example**

LENA 55x35 TRIMLESS 1A 85cm 3000K Diffuser Dimmable with Plastic Angular  
**SKU:** T5535-1A-85-3-C2-D-P

| material           | pcb details                | CRI                                 | lumen output / W |
|--------------------|----------------------------|-------------------------------------|------------------|
| Extruded aluminium | Zhaga-Compliant Dimensions | Ra>80 ( <b>Ra&gt;90</b> on request) | up to 195 Lm/W   |

| covers  | CCT                        | dimming options (D) |
|---|----------------------------|---------------------|
| Acrylic Diffuser<br>(-C1-)<br>       | 3000K (3)                  | Push                |
|   | 4000K (4)                  | DALI                |
| Acrylic Microprismatic<br>(-C2-)<br> | 5000K (5)                  | TRIAC 0/1-10V       |
|   | 6500K (6)                  | CASAMBI             |
|   | TUNABLE 2700K - 6500K (TN) | Analog 0/1-10V      |





RECESSED TRIMLESS



## LENA 55×35 TRIMLESS / Lumen output tables

| CATEGORY 1A 350mA (1A) | code         | length | watt  | lumens<br>3000K | lumens<br>4000K | lumens<br>5000K | lumens<br>6500K |
|------------------------|--------------|--------|-------|-----------------|-----------------|-----------------|-----------------|
|                        | T5535-1A-57  | 57cm   | 7.8   | 1390            | 1470            | 1470            | 1440            |
|                        | T5535-1A-85  | 85cm   | 11.7  | 2085            | 2205            | 2205            | 2160            |
|                        | T5535-1A-113 | 113cm  | 15.6  | 2780            | 2940            | 2940            | 2880            |
|                        | T5535-1A-141 | 141cm  | 19.5  | 3475            | 3675            | 3675            | 3600            |
|                        | T5535-1A-169 | 169cm  | 23.4  | 4170            | 4410            | 4410            | 4320            |
|                        | T5535-1A-197 | 197cm  | 27.3  | 4865            | 5145            | 5145            | 5040            |
|                        | T5535-1A-225 | 225cm  | 31.2  | 5560            | 5880            | 5880            | 5760            |
|                        | T5535-1A-253 | 253cm  | 35.1  | 6255            | 6615            | 6615            | 6480            |
|                        | T5535-1A-281 | 281cm  | 39    | 6950            | 7350            | 7350            | 7200            |
|                        | T5535-1A-309 | 309cm  | 42.9  | 7645            | 8085            | 8085            | 7920            |
|                        | T5535-1A-337 | 337cm  | 46.8  | 8340            | 8820            | 8820            | 8640            |
|                        | T5535-1A-365 | 365cm  | 50.7  | 9035            | 9555            | 9555            | 9360            |
|                        | T5535-1A-393 | 393cm  | 54.6  | 9730            | 10290           | 10290           | 10080           |
|                        | T5535-1A-421 | 421cm  | 58.5  | 10425           | 11025           | 11025           | 10800           |
| T5535-1A-449           | 449cm        | 62.4   | 11120 | 11760           | 11760           | 11520           |                 |

wattage: 13.5 W/m

|              |       |      |       |       |       |       |
|--------------|-------|------|-------|-------|-------|-------|
| T5535-1B-57  | 57cm  | 11.6 | 1960  | 2070  | 2070  | 2020  |
| T5535-1B-85  | 85cm  | 17.4 | 2940  | 3105  | 3105  | 3030  |
| T5535-1B-113 | 113cm | 23.2 | 3920  | 4140  | 4140  | 4040  |
| T5535-1B-141 | 141cm | 29   | 4900  | 5175  | 5175  | 5050  |
| T5535-1B-169 | 169cm | 34.8 | 5880  | 6210  | 6210  | 6060  |
| T5535-1B-197 | 197cm | 40.6 | 6860  | 7245  | 7245  | 7070  |
| T5535-1B-225 | 225cm | 46.4 | 7840  | 8280  | 8280  | 8080  |
| T5535-1B-253 | 253cm | 52.2 | 8820  | 9315  | 9315  | 9090  |
| T5535-1B-281 | 281cm | 58   | 9800  | 10350 | 10350 | 10100 |
| T5535-1B-309 | 309cm | 63.8 | 10780 | 11385 | 11385 | 11110 |
| T5535-1B-337 | 337cm | 69.6 | 11760 | 12420 | 12420 | 12120 |
| T5535-1B-365 | 365cm | 75.4 | 12740 | 13455 | 13455 | 13130 |
| T5535-1B-393 | 393cm | 81.2 | 13720 | 14490 | 14490 | 14140 |
| T5535-1B-421 | 421cm | 87   | 14700 | 15525 | 15525 | 15150 |
| T5535-1B-449 | 449cm | 92.8 | 15680 | 16560 | 16560 | 16160 |

wattage: 20 W/m

Το φωτιστικό είναι διαθέσιμο σε μήκος πολλαπλάσιο των 14 εκατοστών

The illuminant is available in lengths that are multiples of 14 centimeters.

## LENA 55×35 TRIMLESS / Lumen output tables

| CATEGORY 2A 350mA (2A) | code         | length | watt  | lumens 3000K | lumens 4000K | lumens 5000K | lumens 6500K |
|------------------------|--------------|--------|-------|--------------|--------------|--------------|--------------|
|                        | T5535-2A-57  | 57cm   | 23.6  | 4080         | 4380         | 4380         | 4080         |
|                        | T5535-2A-85  | 85cm   | 35.4  | 6120         | 6570         | 6570         | 6120         |
|                        | T5535-2A-113 | 113cm  | 47.2  | 8160         | 8760         | 8760         | 8160         |
|                        | T5535-2A-141 | 141cm  | 59    | 10200        | 10950        | 10950        | 10200        |
|                        | T5535-2A-169 | 169cm  | 70.8  | 12240        | 13140        | 13140        | 12240        |
|                        | T5535-2A-197 | 197cm  | 82.6  | 14280        | 15330        | 15330        | 14280        |
|                        | T5535-2A-225 | 225cm  | 94.4  | 16320        | 17520        | 17520        | 16320        |
|                        | T5535-2A-253 | 253cm  | 106.2 | 18360        | 19710        | 19710        | 18360        |
|                        | T5535-2A-281 | 281cm  | 118   | 20400        | 21900        | 21900        | 20400        |
|                        | T5535-2A-309 | 309cm  | 129.8 | 22440        | 24090        | 24090        | 22440        |
|                        | T5535-2A-337 | 337cm  | 141.6 | 24480        | 26280        | 26280        | 24480        |
|                        | T5535-2A-365 | 365cm  | 153.4 | 26520        | 28470        | 28470        | 26520        |
|                        | T5535-2A-393 | 393cm  | 165.2 | 28560        | 30660        | 30660        | 28560        |
|                        | T5535-2A-421 | 421cm  | 177   | 30600        | 32850        | 32850        | 30600        |
| T5535-2A-449           | 449cm        | 188.8  | 32640 | 35040        | 35040        | 32640        |              |

wattage: 40.5 W/m

| CATEGORY 2B 500mA (2B) | code         | length | watt  | lumens 3000K | lumens 4000K | lumens 5000K | lumens 6500K |
|------------------------|--------------|--------|-------|--------------|--------------|--------------|--------------|
|                        | T5535-2B-57  | 57cm   | 35    | 5700         | 6140         | 6140         | 5700         |
|                        | T5535-2B-85  | 85cm   | 52.5  | 8550         | 9210         | 9210         | 8550         |
|                        | T5535-2B-113 | 113cm  | 70    | 11400        | 12280        | 12280        | 11400        |
|                        | T5535-2B-141 | 141cm  | 87.5  | 14250        | 15350        | 15350        | 14250        |
|                        | T5535-2B-169 | 169cm  | 105   | 17100        | 18420        | 18420        | 17100        |
|                        | T5535-2B-197 | 197cm  | 122.5 | 19950        | 21490        | 21490        | 19950        |
|                        | T5535-2B-225 | 225cm  | 140   | 22800        | 24560        | 24560        | 22800        |
|                        | T5535-2B-253 | 253cm  | 157.5 | 25650        | 27630        | 27630        | 25650        |
|                        | T5535-2B-281 | 281cm  | 175   | 28500        | 30700        | 30700        | 28500        |
|                        | T5535-2B-309 | 309cm  | 192.5 | 31350        | 33770        | 33770        | 31350        |
|                        | T5535-2B-337 | 337cm  | 210   | 34200        | 36840        | 36840        | 34200        |
|                        | T5535-2B-365 | 365cm  | 227.5 | 37050        | 39910        | 39910        | 37050        |
|                        | T5535-2B-393 | 393cm  | 245   | 39900        | 42980        | 42980        | 39900        |
|                        | T5535-2B-421 | 421cm  | 262.5 | 42750        | 46050        | 46050        | 42750        |
| T5535-2B-449           | 449cm        | 280    | 45600 | 49120        | 49120        | 45600        |              |

wattage: 60.5 W/m

Το φωτιστικό είναι διαθέσιμο σε μήκος πολλαπλάσιο των 14 εκατοστών  
 The illuminant is available in lengths that are multiples of 14 centimeters.

DARK LENA 55x35 TRIMLESS (TD5535-)



**(-M-)**  
 χωνευτή τοποθέτηση με  
 γωνιόκρανο αλουμινίου  
 Trimless Installation with  
 aluminium angular

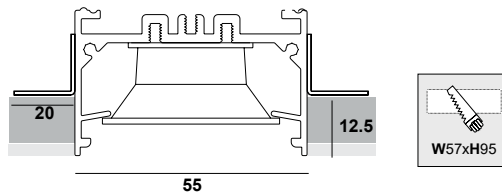

**(-P-)**  
 χωνευτή τοποθέτηση με  
 πλαστικό γωνιόκρανο  
 Trimless Installation with  
 plastic angular

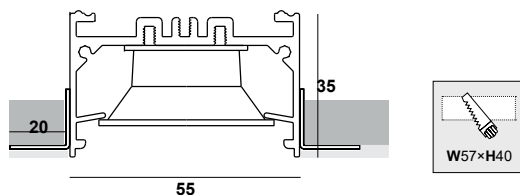

| material                     | pcb details          | CRI                      | lumen output / W |
|------------------------------|----------------------|--------------------------|------------------|
| Extruded aluminium / Plastic | SMD light & dark 7x1 | Ra>90 (Ra>80 on request) | up to 205 Lm/W   |

| CCT                        | beam angle       | reflector color | dimming options (D) |
|----------------------------|------------------|-----------------|---------------------|
| 3000K (3)                  | Medium 65° (60D) | Black (1)       | Push                |
| 4000K (4)                  | Wide 90° (90D)   | White (2)       | DALI                |
| TUNABLE 2700K - 6500K (TN) |                  |                 | TRIAC 0/1-10V       |
|                            |                  |                 | CASAMBI             |
|                            |                  |                 | Analog 0/1-10V      |

## DARK LENA 55×35 TRIMLESS / Lumen output tables

| CATEGORY 1A 350mA (1A) | code            | length  | watt  | lumens<br>3000K (65°) | lumens<br>3000K (90°) | lumens<br>4000K (65°) | lumens<br>4000K (90°) |
|------------------------|-----------------|---------|-------|-----------------------|-----------------------|-----------------------|-----------------------|
|                        | TD5535-1A-56.5  | 56.5cm  | 13.4  | 1702                  | 1680                  | 1774                  | 1752                  |
|                        | TD5535-1A-84.5  | 84.5cm  | 20.1  | 2553                  | 2520                  | 2661                  | 2628                  |
|                        | TD5535-1A-112.5 | 112.5cm | 26.8  | 3404                  | 3360                  | 3548                  | 3504                  |
|                        | TD5535-1A-140.5 | 140.5cm | 33.5  | 4255                  | 4200                  | 4435                  | 4380                  |
|                        | TD5535-1A-168.5 | 168.5cm | 40.2  | 5106                  | 5040                  | 5322                  | 5256                  |
|                        | TD5535-1A-196.5 | 196.5cm | 46.9  | 5957                  | 5880                  | 6209                  | 6132                  |
|                        | TD5535-1A-224.5 | 224.5cm | 53.6  | 6808                  | 6720                  | 7096                  | 7008                  |
|                        | TD5535-1A-252.5 | 252.5cm | 60.3  | 7659                  | 7560                  | 7983                  | 7884                  |
|                        | TD5535-1A-280.5 | 280.5cm | 67    | 8510                  | 8400                  | 8870                  | 8760                  |
|                        | TD5535-1A-308.5 | 308.5cm | 73.7  | 9361                  | 9240                  | 9757                  | 9636                  |
|                        | TD5535-1A-336.5 | 336.5cm | 80.4  | 10212                 | 10080                 | 10644                 | 10512                 |
|                        | TD5535-1A-364.5 | 364.5cm | 87.1  | 11063                 | 10920                 | 11531                 | 11388                 |
|                        | TD5535-1A-392.5 | 392.5cm | 93.8  | 11914                 | 11760                 | 12418                 | 12264                 |
|                        | TD5535-1A-420.5 | 420.5cm | 100.5 | 12765                 | 12600                 | 13305                 | 13140                 |
|                        | TD5535-1A-448.5 | 448.5cm | 107.2 | 13616                 | 13440                 | 14192                 | 14016                 |

wattage: 23 W/m

|                 |         |       |       |       |       |       |
|-----------------|---------|-------|-------|-------|-------|-------|
| TD5535-1B-56.5  | 56.5cm  | 19.8  | 2398  | 2368  | 2512  | 2480  |
| TD5535-1B-84.5  | 84.5cm  | 29.7  | 3597  | 3552  | 3768  | 3720  |
| TD5535-1B-112.5 | 112.5cm | 39.6  | 4796  | 4736  | 5024  | 4960  |
| TD5535-1B-140.5 | 140.5cm | 49.5  | 5995  | 5920  | 6280  | 6200  |
| TD5535-1B-168.5 | 168.5cm | 59.4  | 7194  | 7104  | 7536  | 7440  |
| TD5535-1B-196.5 | 196.5cm | 69.3  | 8393  | 8288  | 8792  | 8680  |
| TD5535-1B-224.5 | 224.5cm | 79.2  | 9592  | 9472  | 10048 | 9920  |
| TD5535-1B-252.5 | 252.5cm | 89.1  | 10791 | 10656 | 11304 | 11160 |
| TD5535-1B-280.5 | 280.5cm | 99    | 11990 | 11840 | 12560 | 12400 |
| TD5535-1B-308.5 | 308.5cm | 108.9 | 13189 | 13024 | 13816 | 13640 |
| TD5535-1B-336.5 | 336.5cm | 118.8 | 14388 | 14208 | 15072 | 14880 |
| TD5535-1B-364.5 | 364.5cm | 128.7 | 15587 | 15392 | 16328 | 16120 |
| TD5535-1B-392.5 | 392.5cm | 138.6 | 16786 | 16576 | 17584 | 17360 |
| TD5535-1B-420.5 | 420.5cm | 148.5 | 17985 | 17760 | 18840 | 18600 |
| TD5535-1B-448.5 | 448.5cm | 158.4 | 19184 | 18944 | 20096 | 19840 |

wattage: 34 W/m

Το φωτιστικό είναι διαθέσιμο σε μήκος πολλαπλάσιο των 28 εκατοστών

The illuminant is available in lengths that are multiples of 28 centimeters.

|                                  |   |                       |   |                 |   |  |   |                            |   |   |   |  |   |   |
|----------------------------------|---|-----------------------|---|-----------------|---|--|---|----------------------------|---|---|---|--|---|---|
| TD5535                           | - | XX                    | - | XXX             | - | X  | - | XXX                        | - | X   | - | X                                      | - | X   |
| (a)                              |   | (b)                   |   | (c)             |   | (d)  |   | (e)                        |   | (f)                                       |   | (g)                                    |   | (h)   |
| Κωδικός Γραμμικού<br>Linear Code |   | Κατηγορία<br>Category |   | Μήκος<br>Length |   | Θερμοκρασία<br>φωτός<br>Color<br>Temperature |   | Γωνία Δέσμης<br>Beam Angle |   | Χρώμα<br>Ρεφλέκτορα<br>Reflector<br>Color |   | Αυξομείωση<br>έντασης φωτός<br>Dimming |   | Χωνευτή<br>τοποθέτηση<br>Trimless<br>installation |

### Παράδειγμα κωδικού / Code example

DARK LENA 55×35 TRIMLESS 1A 84.5cm 3000K 65° Black Reflector Dimmable with Plastic Angular  
SKU: TD5535-1A-84-3-60D-1-D-P

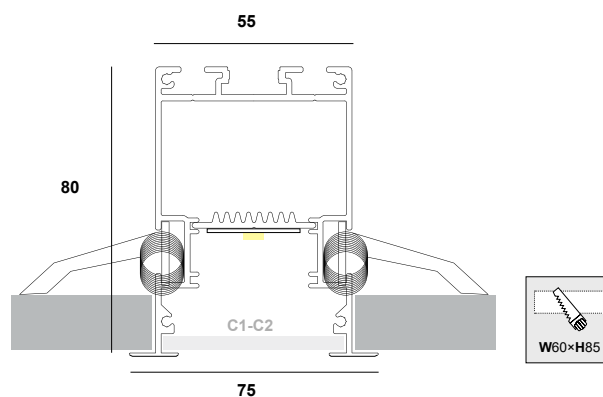

# T5580 - XX - XXX - X - XX - XX - X

- (a)  
Κωδικός Γραμμικού  
Linear Code
- (b)  
Κατηγορία  
Category
- (c)  
Μήκος  
Length
- (d)  
Θερμοκρασία  
φωτός  
Color  
Temperature
- (e)  
Χρώμα  
προφίλ  
Profile  
Color
- (e)  
Κάλυμμα  
Cover
- (f)  
Αυτομείωση  
έντασης φωτός  
Dimming

**Παράδειγμα κωδικού / Code example**

NILE 55×80 RECESSED 1A 85cm 3000K Black Diffuser Dimmable

SKU: T5580-1A-85-3-BL-C1-D

| material           | pcb details                | CRI                      | lumen output / W |
|--------------------|----------------------------|--------------------------|------------------|
| Extruded aluminium | Zhaga-Compliant Dimensions | Ra>80 (Ra>90 on request) | up to 195 Lm/W   |

| covers                    | profile color | CCT                           | dimming options (D) |
|---------------------------|---------------|-------------------------------|---------------------|
| Diffuser 3mm (-C1-)       | Anodised (AN) | 3000K (3)                     | Push                |
|                           | Black (BL)    | 4000K (4)                     | DALI                |
|                           | White (WH)    | 5000K (5)                     | TRIAC 0/1-10V       |
| Microprismatic 3mm (-C2-) | RAL (RL)      | 6500K (6)                     | CASAMBI             |
|                           |               | TUNABLE<br>2700K - 6500K (TN) | Analog 0/1-10V      |



RECESSED TRIMLESS



## NILE 55×80 RECESSED / Lumen output tables

| CATEGORY 1A 350mA (1A) | code         | length | watt  | lumens 3000K | lumens 4000K | lumens 5000K | lumens 6500K |
|------------------------|--------------|--------|-------|--------------|--------------|--------------|--------------|
|                        | T5580-1A-57  | 57cm   | 7.8   | 1390         | 1470         | 1470         | 1440         |
|                        | T5580-1A-85  | 85cm   | 11.7  | 2085         | 2205         | 2205         | 2160         |
|                        | T5580-1A-113 | 113cm  | 15.6  | 2780         | 2940         | 2940         | 2880         |
|                        | T5580-1A-141 | 141cm  | 19.5  | 3475         | 3675         | 3675         | 3600         |
|                        | T5580-1A-169 | 169cm  | 23.4  | 4170         | 4410         | 4410         | 4320         |
|                        | T5580-1A-197 | 197cm  | 27.3  | 4865         | 5145         | 5145         | 5040         |
|                        | T5580-1A-225 | 225cm  | 31.2  | 5560         | 5880         | 5880         | 5760         |
|                        | T5580-1A-253 | 253cm  | 35.1  | 6255         | 6615         | 6615         | 6480         |
|                        | T5580-1A-281 | 281cm  | 39    | 6950         | 7350         | 7350         | 7200         |
|                        | T5580-1A-309 | 309cm  | 42.9  | 7645         | 8085         | 8085         | 7920         |
|                        | T5580-1A-337 | 337cm  | 46.8  | 8340         | 8820         | 8820         | 8640         |
|                        | T5580-1A-365 | 365cm  | 50.7  | 9035         | 9555         | 9555         | 9360         |
|                        | T5580-1A-393 | 393cm  | 54.6  | 9730         | 10290        | 10290        | 10080        |
|                        | T5580-1A-421 | 421cm  | 58.5  | 10425        | 11025        | 11025        | 10800        |
| T5580-1A-449           | 449cm        | 62.4   | 11120 | 11760        | 11760        | 11520        |              |

wattage: 13.5 W/m

|              |       |      |       |       |       |       |
|--------------|-------|------|-------|-------|-------|-------|
| T5580-1B-57  | 57cm  | 11.6 | 1960  | 2070  | 2070  | 2020  |
| T5580-1B-85  | 85cm  | 17.4 | 2940  | 3105  | 3105  | 3030  |
| T5580-1B-113 | 113cm | 23.2 | 3920  | 4140  | 4140  | 4040  |
| T5580-1B-141 | 141cm | 29   | 4900  | 5175  | 5175  | 5050  |
| T5580-1B-169 | 169cm | 34.8 | 5880  | 6210  | 6210  | 6060  |
| T5580-1B-197 | 197cm | 40.6 | 6860  | 7245  | 7245  | 7070  |
| T5580-1B-225 | 225cm | 46.4 | 7840  | 8280  | 8280  | 8080  |
| T5580-1B-253 | 253cm | 52.2 | 8820  | 9315  | 9315  | 9090  |
| T5580-1B-281 | 281cm | 58   | 9800  | 10350 | 10350 | 10100 |
| T5580-1B-309 | 309cm | 63.8 | 10780 | 11385 | 11385 | 11110 |
| T5580-1B-337 | 337cm | 69.6 | 11760 | 12420 | 12420 | 12120 |
| T5580-1B-365 | 365cm | 75.4 | 12740 | 13455 | 13455 | 13130 |
| T5580-1B-393 | 393cm | 81.2 | 13720 | 14490 | 14490 | 14140 |
| T5580-1B-421 | 421cm | 87   | 14700 | 15525 | 15525 | 15150 |
| T5580-1B-449 | 449cm | 92.8 | 15680 | 16560 | 16560 | 16160 |

wattage: 20 W/m

Το φωτιστικό είναι διαθέσιμο σε μήκος πολλαπλάσιο των 14 εκατοστών

The illuminant is available in lengths that are multiples of 14 centimeters.

## NILE 55×80 RECESSED / Lumen output tables

| CATEGORY 2A 350mA (2A) | code         | length | watt  | lumens<br>3000K | lumens<br>4000K | lumens<br>5000K | lumens<br>6500K |
|------------------------|--------------|--------|-------|-----------------|-----------------|-----------------|-----------------|
|                        | T5580-2A-57  | 57cm   | 23.6  | 4080            | 4380            | 4380            | 4080            |
|                        | T5580-2A-85  | 85cm   | 35.4  | 6120            | 6570            | 6570            | 6120            |
|                        | T5580-2A-113 | 113cm  | 47.2  | 8160            | 8760            | 8760            | 8160            |
|                        | T5580-2A-141 | 141cm  | 59    | 10200           | 10950           | 10950           | 10200           |
|                        | T5580-2A-169 | 169cm  | 70.8  | 12240           | 13140           | 13140           | 12240           |
|                        | T5580-2A-197 | 197cm  | 82.6  | 14280           | 15330           | 15330           | 14280           |
|                        | T5580-2A-225 | 225cm  | 94.4  | 16320           | 17520           | 17520           | 16320           |
|                        | T5580-2A-253 | 253cm  | 106.2 | 18360           | 19710           | 19710           | 18360           |
|                        | T5580-2A-281 | 281cm  | 118   | 20400           | 21900           | 21900           | 20400           |
|                        | T5580-2A-309 | 309cm  | 129.8 | 22440           | 24090           | 24090           | 22440           |
|                        | T5580-2A-337 | 337cm  | 141.6 | 24480           | 26280           | 26280           | 24480           |
|                        | T5580-2A-365 | 365cm  | 153.4 | 26520           | 28470           | 28470           | 26520           |
|                        | T5580-2A-393 | 393cm  | 165.2 | 28560           | 30660           | 30660           | 28560           |
|                        | T5580-2A-421 | 421cm  | 177   | 30600           | 32850           | 32850           | 30600           |
| T5580-2A-449           | 449cm        | 188.8  | 32640 | 35040           | 35040           | 32640           |                 |

wattage: 40.5 W/m

| CATEGORY 2B 500mA (2B) | code         | length | watt  | lumens<br>3000K | lumens<br>4000K | lumens<br>5000K | lumens<br>6500K |
|------------------------|--------------|--------|-------|-----------------|-----------------|-----------------|-----------------|
|                        | T5580-2B-57  | 57cm   | 35    | 5700            | 6140            | 6140            | 5700            |
|                        | T5580-2B-85  | 85cm   | 52.5  | 8550            | 9210            | 9210            | 8550            |
|                        | T5580-2B-113 | 113cm  | 70    | 11400           | 12280           | 12280           | 11400           |
|                        | T5580-2B-141 | 141cm  | 87.5  | 14250           | 15350           | 15350           | 14250           |
|                        | T5580-2B-169 | 169cm  | 105   | 17100           | 18420           | 18420           | 17100           |
|                        | T5580-2B-197 | 197cm  | 122.5 | 19950           | 21490           | 21490           | 19950           |
|                        | T5580-2B-225 | 225cm  | 140   | 22800           | 24560           | 24560           | 22800           |
|                        | T5580-2B-253 | 253cm  | 157.5 | 25650           | 27630           | 27630           | 25650           |
|                        | T5580-2B-281 | 281cm  | 175   | 28500           | 30700           | 30700           | 28500           |
|                        | T5580-2B-309 | 309cm  | 192.5 | 31350           | 33770           | 33770           | 31350           |
|                        | T5580-2B-337 | 337cm  | 210   | 34200           | 36840           | 36840           | 34200           |
|                        | T5580-2B-365 | 365cm  | 227.5 | 37050           | 39910           | 39910           | 37050           |
|                        | T5580-2B-393 | 393cm  | 245   | 39900           | 42980           | 42980           | 39900           |
|                        | T5580-2B-421 | 421cm  | 262.5 | 42750           | 46050           | 46050           | 42750           |
| T5580-2B-449           | 449cm        | 280    | 45600 | 49120           | 49120           | 45600           |                 |

wattage: 60.5 W/m

Το φωτιστικό είναι διαθέσιμο σε μήκος πολλαπλάσιο των 14 εκατοστών

The illuminant is available in lengths that are multiples of 14 centimeters.



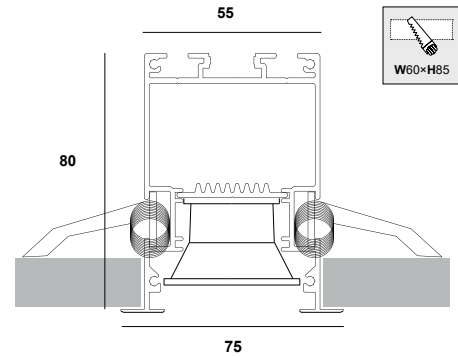

TD5580 - XX - XXX - X - XXX - XX - X - X

| (a)                              | (b)                   | (c)             | (d)  | (e)                        | (f)                                 | (g)                                       | (h)                                       |
|----------------------------------|-----------------------|-----------------|--|----------------------------|-------------------------------------|---|---|
| Κωδικός Γραμμικού<br>Linear Code | Κατηγορία<br>Category | Μήκος<br>Length | Θερμοκρασία<br>φωτός<br>Color<br>Temperature | Γωνία Δέσμης<br>Beam Angle | Χρώμα<br>προφίλ<br>Profile<br>Color | Χρώμα<br>Ρεφλέκτορα<br>Reflector<br>Color | Αυξομείωση<br>έντασης<br>φωτός<br>Dimming |

**Παράδειγμα κωδικού / Code example**

DARK NILE 55×80 RECESSED 1A 84.5cm 3000K 65° Black with Black Reflector Dimmable  
SKU: TD5580-1A-85-3-60D-BL-1-D

| material                     | pcb details          | CRI                      | lumen output / W |
|------------------------------|----------------------|--------------------------|------------------|
| Extruded aluminium / Plastic | SMD light & dark 7×1 | Ra>90 (Ra>80 on request) | up to 205 Lm/W   |

| CCT                           | beam angle       | profile color | reflector color | dimming options (D) |
|-------------------------------|------------------|---------------|-----------------|---------------------|
| 3000K (3)                     | Medium 65° (60D) | Anodised (AN) | Black (1)       | Push                |
| 4000K (4)                     | Wide 90° (90D)   | Black (BL)    | White (2)       | DALI                |
| TUNABLE<br>2700K - 6500K (TN) |                  | White (WH)    |                 | TRIAC 0/1-10V       |
|                               |                  | RAL (RL)      |                 | CASAMBI             |
|                               |                  |               |                 | Analog 0/1-10V      |

**Εναλλακτική τοποθέτηση φακού / Alternative lens placement**

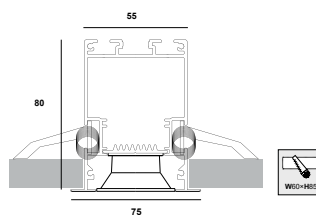

## DARK NILE 55×80 RECESSED / Lumen output tables

| CATEGORY 1A 350mA (1A) | code            | length  | watt  | lumens<br>3000K (65°) | lumens<br>3000K (90°) | lumens<br>4000K (65°) | lumens<br>4000K (90°) |
|------------------------|-----------------|---------|-------|-----------------------|-----------------------|-----------------------|-----------------------|
|                        | TD5580-1A-56.5  | 56.5cm  | 13.4  | 1702                  | 1680                  | 1774                  | 1752                  |
|                        | TD5580-1A-84.5  | 84.5cm  | 20.1  | 2553                  | 2520                  | 2661                  | 2628                  |
|                        | TD5580-1A-112.5 | 112.5cm | 26.8  | 3404                  | 3360                  | 3548                  | 3504                  |
|                        | TD5580-1A-140.5 | 140.5cm | 33.5  | 4255                  | 4200                  | 4435                  | 4380                  |
|                        | TD5580-1A-168.5 | 168.5cm | 40.2  | 5106                  | 5040                  | 5322                  | 5256                  |
|                        | TD5580-1A-196.5 | 196.5cm | 46.9  | 5957                  | 5880                  | 6209                  | 6132                  |
|                        | TD5580-1A-224.5 | 224.5cm | 53.6  | 6808                  | 6720                  | 7096                  | 7008                  |
|                        | TD5580-1A-252.5 | 252.5cm | 60.3  | 7659                  | 7560                  | 7983                  | 7884                  |
|                        | TD5580-1A-280.5 | 280.5cm | 67    | 8510                  | 8400                  | 8870                  | 8760                  |
|                        | TD5580-1A-308.5 | 308.5cm | 73.7  | 9361                  | 9240                  | 9757                  | 9636                  |
|                        | TD5580-1A-336.5 | 336.5cm | 80.4  | 10212                 | 10080                 | 10644                 | 10512                 |
|                        | TD5580-1A-364.5 | 364.5cm | 87.1  | 11063                 | 10920                 | 11531                 | 11388                 |
|                        | TD5580-1A-392.5 | 392.5cm | 93.8  | 11914                 | 11760                 | 12418                 | 12264                 |
|                        | TD5580-1A-420.5 | 420.5cm | 100.5 | 12765                 | 12600                 | 13305                 | 13140                 |
|                        | TD5580-1A-448.5 | 448.5cm | 107.2 | 13616                 | 13440                 | 14192                 | 14016                 |

wattage: 23 W/m

| CATEGORY 1B 500mA (1B) | code            | length  | watt  | lumens<br>3000K (65°) | lumens<br>3000K (90°) | lumens<br>4000K (65°) | lumens<br>4000K (90°) |
|------------------------|-----------------|---------|-------|-----------------------|-----------------------|-----------------------|-----------------------|
|                        | TD5580-1B-56.5  | 56.5cm  | 19.8  | 2398                  | 2368                  | 2512                  | 2480                  |
|                        | TD5580-1B-84.5  | 84.5cm  | 29.7  | 3597                  | 3552                  | 3768                  | 3720                  |
|                        | TD5580-1B-112.5 | 112.5cm | 39.6  | 4796                  | 4736                  | 5024                  | 4960                  |
|                        | TD5580-1B-140.5 | 140.5cm | 49.5  | 5995                  | 5920                  | 6280                  | 6200                  |
|                        | TD5580-1B-168.5 | 168.5cm | 59.4  | 7194                  | 7104                  | 7536                  | 7440                  |
|                        | TD5580-1B-196.5 | 196.5cm | 69.3  | 8393                  | 8288                  | 8792                  | 8680                  |
|                        | TD5580-1B-224.5 | 224.5cm | 79.2  | 9592                  | 9472                  | 10048                 | 9920                  |
|                        | TD5580-1B-252.5 | 252.5cm | 89.1  | 10791                 | 10656                 | 11304                 | 11160                 |
|                        | TD5580-1B-280.5 | 280.5cm | 99    | 11990                 | 11840                 | 12560                 | 12400                 |
|                        | TD5580-1B-308.5 | 308.5cm | 108.9 | 13189                 | 13024                 | 13816                 | 13640                 |
|                        | TD5580-1B-336.5 | 336.5cm | 118.8 | 14388                 | 14208                 | 15072                 | 14880                 |
|                        | TD5580-1B-364.5 | 364.5cm | 128.7 | 15587                 | 15392                 | 16328                 | 16120                 |
|                        | TD5580-1B-392.5 | 392.5cm | 138.6 | 16786                 | 16576                 | 17584                 | 17360                 |
|                        | TD5580-1B-420.5 | 420.5cm | 148.5 | 17985                 | 17760                 | 18840                 | 18600                 |
|                        | TD5580-1B-448.5 | 448.5cm | 158.4 | 19184                 | 18944                 | 20096                 | 19840                 |

wattage: 34 W/m

*Το φωτιστικό είναι διαθέσιμο σε μήκος πολλαπλάσιο των 28 εκατοστών*

*The illuminant is available in lengths that are multiples of 28 centimeters.*





ΕΠΙΤΟΙΧΑ / SURFACE MOUNTED

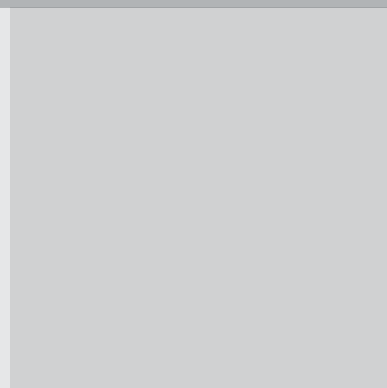

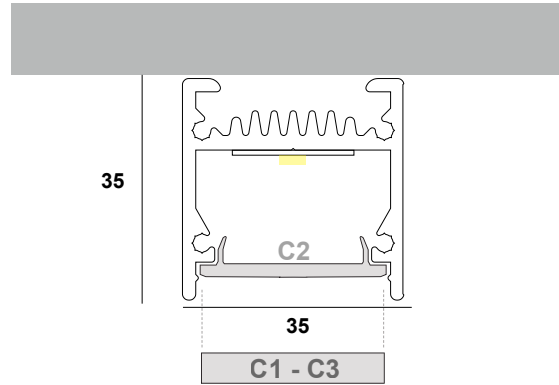

35 - XX - XXX - X - XX - XX - X - XXX

(a) (b) (c) (d) (e) (f) (g) (h)

Κωδικός  
Γραμμικού  
Linear Code

Κατηγορία  
Category

Μήκος  
Length

Θερμοκρασία  
φωτός  
Color  
Temperature

Χρώμα  
προφίλ  
Profile  
color

Κάλυμμα  
Cover

Αυξομείωση  
έντασης φωτός  
Dimming

Τοποθέτηση  
τροφοδοτικού  
Power supply  
installation

**Παράδειγμα κωδικού / Code example**

GILA 35×35 88cm 1A 3000K Black Dimmable with Slide Diffuser 1.5mm (Hidden power supply)

SKU: 35-1A-88-3-C2-D-PS2

| material           | pcb details                | CRI                      | lumen output / W |
|--------------------|----------------------------|--------------------------|------------------|
| Extruded aluminium | Zhaga-Compliant Dimensions | Ra>80 (Ra>90 on request) | up to 195 Lm/W   |

| covers   | profile color | CCT                           | dimming options (D) |
|--|---------------|-------------------------------|---------------------|
| Slide Diffuser 5mm<br>(-C1-)                       | Anodised (AN) | 3000K (3)                     | Push                |
|  | Black (BL)    | 4000K (4)                     | DALI                |
|  | White (WH)    | 5000K (5)                     | TRIAC 0/1-10V       |
| Click diffuser 1.5mm<br>(up to 70m reel)<br>(-C2-) | RAL (RL)      | 6500K (6)                     | CASAMBI             |
|  |               | TUNABLE<br>2700K - 6500K (TN) | Analog 0/1-10V      |
| Microprismatic<br>(-C3-)                           |               |                               |                     |

**power supply installation**

|  |   |
|--|---|
| <p>Πάνω στο προφίλ με ροζέτα<br/>On the profile with rosette<br/>(-PS1-)</p> | <p>Κρυφό με πρόσβαση στο τροφοδοτικό<br/>Hidden with access to the power supply<br/>(-PS2-)</p> |
|--|---|



SURFACE MOUNTED

## GILA 35×35 / Lumen output tables

|                        | code      | length | watt | lumens<br>3000K | lumens<br>4000K | lumens<br>5000K | lumens<br>6500K |
|------------------------|-----------|--------|------|-----------------|-----------------|-----------------|-----------------|
| CATEGORY 1A 350mA (1A) | 35-1A-60  | 60cm   | 7.8  | 1390            | 1470            | 1470            | 1440            |
|                        | 35-1A-88  | 88cm   | 11.7 | 2085            | 2205            | 2205            | 2160            |
|                        | 35-1A-116 | 116cm  | 15.6 | 2780            | 2940            | 2940            | 2880            |
|                        | 35-1A-144 | 144cm  | 19.5 | 3475            | 3675            | 3675            | 3600            |
|                        | 35-1A-173 | 173cm  | 23.4 | 4170            | 4410            | 4410            | 4320            |
|                        | 35-1A-201 | 201cm  | 27.3 | 4865            | 5145            | 5145            | 5040            |
|                        | 35-1A-229 | 229cm  | 31.2 | 5560            | 5880            | 5880            | 5760            |
|                        | 35-1A-257 | 257cm  | 35.1 | 6255            | 6615            | 6615            | 6480            |
|                        | 35-1A-285 | 285cm  | 39   | 6950            | 7350            | 7350            | 7200            |
|                        | 35-1A-313 | 313cm  | 42.9 | 7645            | 8085            | 8085            | 7920            |
|                        | 35-1A-342 | 342cm  | 46.8 | 8340            | 8820            | 8820            | 8640            |
|                        | 35-1A-370 | 370cm  | 50.7 | 9035            | 9555            | 9555            | 9360            |
|                        | 35-1A-399 | 399cm  | 54.6 | 9730            | 10290           | 10290           | 10080           |
|                        | 35-1A-427 | 427cm  | 58.5 | 10425           | 11025           | 11025           | 10800           |
|                        | 35-1A-455 | 455cm  | 62.4 | 11120           | 11760           | 11760           | 11520           |

wattage: 13.5 W/m

|                        |           |       |      |       |       |       |       |
|------------------------|-----------|-------|------|-------|-------|-------|-------|
| CATEGORY 1B 500mA (1B) | 35-1B-60  | 60cm  | 11.6 | 1960  | 2070  | 2070  | 2020  |
|                        | 35-1B-88  | 88cm  | 17.4 | 2940  | 3105  | 3105  | 3030  |
|                        | 35-1B-116 | 116cm | 23.2 | 3920  | 4140  | 4140  | 4040  |
|                        | 35-1B-144 | 144cm | 29   | 4900  | 5175  | 5175  | 5050  |
|                        | 35-1B-173 | 173cm | 34.8 | 5880  | 6210  | 6210  | 6060  |
|                        | 35-1B-201 | 201cm | 40.6 | 6860  | 7245  | 7245  | 7070  |
|                        | 35-1B-229 | 229cm | 46.4 | 7840  | 8280  | 8280  | 8080  |
|                        | 35-1B-257 | 257cm | 52.2 | 8820  | 9315  | 9315  | 9090  |
|                        | 35-1B-285 | 285cm | 58   | 9800  | 10350 | 10350 | 10100 |
|                        | 35-1B-313 | 313cm | 63.8 | 10780 | 11385 | 11385 | 11110 |
|                        | 35-1B-342 | 342cm | 69.6 | 11760 | 12420 | 12420 | 12120 |
|                        | 35-1B-370 | 370cm | 75.4 | 12740 | 13455 | 13455 | 13130 |
|                        | 35-1B-399 | 399cm | 81.2 | 13720 | 14490 | 14490 | 14140 |
|                        | 35-1B-427 | 427cm | 87   | 14700 | 15525 | 15525 | 15150 |
|                        | 35-1B-455 | 455cm | 92.8 | 15680 | 16560 | 16560 | 16160 |

wattage: 20 W/m

Το φωτιστικό είναι διαθέσιμο σε μήκος πολλαπλάσιο των 14 εκατοστών

The illuminant is available in lengths that are multiples of 14 centimeters.

## GILA 35×35 / Lumen output tables

| CATEGORY 2A 350mA (2A) | code      | length | watt  | lumens<br>3000K | lumens<br>4000K | lumens<br>5000K | lumens<br>6500K |
|------------------------|-----------|--------|-------|-----------------|-----------------|-----------------|-----------------|
|                        | 35-2A-60  | 60cm   | 23.6  | 4080            | 4380            | 4380            | 4080            |
|                        | 35-2A-88  | 88cm   | 35.4  | 6120            | 6570            | 6570            | 6120            |
|                        | 35-2A-116 | 116cm  | 47.2  | 8160            | 8760            | 8760            | 8160            |
|                        | 35-2A-144 | 144cm  | 59    | 10200           | 10950           | 10950           | 10200           |
|                        | 35-2A-173 | 173cm  | 70.8  | 12240           | 13140           | 13140           | 12240           |
|                        | 35-2A-201 | 201cm  | 82.6  | 14280           | 15330           | 15330           | 14280           |
|                        | 35-2A-229 | 229cm  | 94.4  | 16320           | 17520           | 17520           | 16320           |
|                        | 35-2A-257 | 257cm  | 106.2 | 18360           | 19710           | 19710           | 18360           |
|                        | 35-2A-284 | 285cm  | 118   | 20400           | 21900           | 21900           | 20400           |
|                        | 35-2A-313 | 313cm  | 129.8 | 22440           | 24090           | 24090           | 22440           |
|                        | 35-2A-342 | 342cm  | 141.6 | 24480           | 26280           | 26280           | 24480           |
|                        | 35-2A-370 | 370cm  | 153.4 | 26520           | 28470           | 28470           | 26520           |
|                        | 35-2A-399 | 399cm  | 165.2 | 28560           | 30660           | 30660           | 28560           |
|                        | 35-2A-427 | 427cm  | 177   | 30600           | 32850           | 32850           | 30600           |
| 35-2A-455              | 455cm     | 188.8  | 32640 | 35040           | 35040           | 32640           |                 |

wattage: 40.5 W/m

|           |       |       |       |       |       |       |
|-----------|-------|-------|-------|-------|-------|-------|
| 35-2B-60  | 60cm  | 35    | 5700  | 6140  | 6140  | 5700  |
| 35-2B-88  | 88cm  | 52.5  | 8550  | 9210  | 9210  | 8550  |
| 35-2B-116 | 116cm | 70    | 11400 | 12280 | 12280 | 11400 |
| 35-2B-144 | 144cm | 87.5  | 14250 | 15350 | 15350 | 14250 |
| 35-2B-173 | 173cm | 105   | 17100 | 18420 | 18420 | 17100 |
| 35-2B-201 | 201cm | 122.5 | 19950 | 21490 | 21490 | 19950 |
| 35-2B-229 | 229cm | 140   | 22800 | 24560 | 24560 | 22800 |
| 35-2B-257 | 257cm | 157.5 | 25650 | 27630 | 27630 | 25650 |
| 35-2B-285 | 285cm | 175   | 28500 | 30700 | 30700 | 28500 |
| 35-2B-313 | 313cm | 192.5 | 31350 | 33770 | 33770 | 31350 |
| 35-2B-342 | 342cm | 210   | 34200 | 36840 | 36840 | 34200 |
| 35-2B-370 | 370cm | 227.5 | 37050 | 39910 | 39910 | 37050 |
| 35-2B-399 | 399cm | 245   | 39900 | 42980 | 42980 | 39900 |
| 35-2B-427 | 427cm | 262.5 | 42750 | 46050 | 46050 | 42750 |
| 35-2B-455 | 455cm | 280   | 45600 | 49120 | 49120 | 45600 |

wattage: 60.5 W/m

Το φωτιστικό είναι διαθέσιμο σε μήκος πολλαπλάσιο των 14 εκατοστών

The illuminant is available in lengths that are multiples of 14 centimeters.



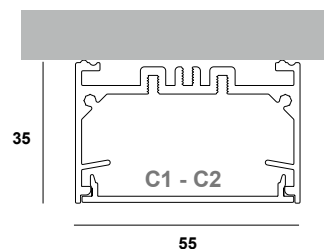

5535 - XX - XXX - X - XX - XX - X

|                                  |                       |                 |  |                                     |                  |  |
|----------------------------------|-----------------------|-----------------|--|-------------------------------------|------------------|--|
| (a)                              | (b)                   | (c)             | (d)  | (e)                                 | (f)              | (g)                                    |
| Κωδικός Γραμμικού<br>Linear Code | Κατηγορία<br>Category | Μήκος<br>Length | Θερμοκρασία<br>φωτός<br>Color<br>Temperature | Χρώμα<br>προφίλ<br>Profile<br>color | Κάλυμμα<br>Cover | Αυξομείωση<br>έντασης φωτός<br>Dimming |

**Παράδειγμα κωδικού / Code example**

LENA 55x35 85cm 1A 3000K Black with Diffuser Dimmable (Hidden power supply)

SKU: 5535-1A-85-3-BL-C1-D-PS3

| material           | pcb details                | CRI                      | lumen output / W |
|--------------------|----------------------------|--------------------------|------------------|
| Extruded aluminium | Zhaga-Compliant Dimensions | Ra>80 (Ra>90 on request) | up to 195 Lm/W   |

| covers                               | profile color | CCT                           | dimming options (D) |
|--------------------------------------|---------------|-------------------------------|---------------------|
| Acrylic Diffuser<br>(-C1-)<br>       | Anodised (AN) | 3000K (3)                     | Push                |
|                                      | Black (BL)    | 4000K (4)                     | DALI                |
|                                      | White (WH)    | 5000K (5)                     | TRIAC 0/1-10V       |
| Acrylic Microprismatic<br>(-C2-)<br> | RAL (RL)      | 6500K (6)                     | CASAMBI             |
|                                      |               | TUNABLE<br>2700K - 6500K (TN) | Analog 0/1-10V      |

**power supply installation**

|   |   |  |
|---|---|--|
| <br>Πάνω στο προφίλ<br>με ροζέτα<br>On the profile<br>with rosette<br>(-PS1-) | <br>Δίπλα στο<br>προφίλ<br>To the side<br>of the profile<br>(-PS2-) | <br>Κρυφό με πρόσβαση<br>στο τροφοδοτικό<br>Hidden with access<br>to the power supply<br>(-PS3-) |
|---|---|--|



SURFACE MOUNTED

## LENA 55×35 / Lumen output tables

| CATEGORY 1A 350mA (1A) | code        | length | watt  | lumens<br>3000K | lumens<br>4000K | lumens<br>5000K | lumens<br>6500K |
|------------------------|-------------|--------|-------|-----------------|-----------------|-----------------|-----------------|
|                        | 5535-1A-57  | 57cm   | 7.8   | 1390            | 1470            | 1470            | 1440            |
|                        | 5535-1A-85  | 85cm   | 11.7  | 2085            | 2205            | 2205            | 2160            |
|                        | 5535-1A-113 | 113cm  | 15.6  | 2780            | 2940            | 2940            | 2880            |
|                        | 5535-1A-141 | 141cm  | 19.5  | 3475            | 3675            | 3675            | 3600            |
|                        | 5535-1A-169 | 169cm  | 23.4  | 4170            | 4410            | 4410            | 4320            |
|                        | 5535-1A-197 | 197cm  | 27.3  | 4865            | 5145            | 5145            | 5040            |
|                        | 5535-1A-225 | 225cm  | 31.2  | 5560            | 5880            | 5880            | 5760            |
|                        | 5535-1A-253 | 253cm  | 35.1  | 6255            | 6615            | 6615            | 6480            |
|                        | 5535-1A-281 | 281cm  | 39    | 6950            | 7350            | 7350            | 7200            |
|                        | 5535-1A-309 | 309cm  | 42.9  | 7645            | 8085            | 8085            | 7920            |
|                        | 5535-1A-337 | 337cm  | 46.8  | 8340            | 8820            | 8820            | 8640            |
|                        | 5535-1A-365 | 365cm  | 50.7  | 9035            | 9555            | 9555            | 9360            |
|                        | 5535-1A-393 | 393cm  | 54.6  | 9730            | 10290           | 10290           | 10080           |
|                        | 5535-1A-421 | 421cm  | 58.5  | 10425           | 11025           | 11025           | 10800           |
| 5535-1A-449            | 449cm       | 62.4   | 11120 | 11760           | 11760           | 11520           |                 |

wattage: 13.5 W/m

|             |       |      |       |       |       |       |
|-------------|-------|------|-------|-------|-------|-------|
| 5535-1B-57  | 57cm  | 11.6 | 1960  | 2070  | 2070  | 2020  |
| 5535-1B-85  | 85cm  | 17.4 | 2940  | 3105  | 3105  | 3030  |
| 5535-1B-113 | 113cm | 23.2 | 3920  | 4140  | 4140  | 4040  |
| 5535-1B-141 | 141cm | 29   | 4900  | 5175  | 5175  | 5050  |
| 5535-1B-169 | 169cm | 34.8 | 5880  | 6210  | 6210  | 6060  |
| 5535-1B-197 | 197cm | 40.6 | 6860  | 7245  | 7245  | 7070  |
| 5535-1B-225 | 225cm | 46.4 | 7840  | 8280  | 8280  | 8080  |
| 5535-1B-253 | 253cm | 52.2 | 8820  | 9315  | 9315  | 9090  |
| 5535-1B-281 | 281cm | 58   | 9800  | 10350 | 10350 | 10100 |
| 5535-1B-309 | 309cm | 63.8 | 10780 | 11385 | 11385 | 11110 |
| 5535-1B-337 | 337cm | 69.6 | 11760 | 12420 | 12420 | 12120 |
| 5535-1B-365 | 365cm | 75.4 | 12740 | 13455 | 13455 | 13130 |
| 5535-1B-393 | 393cm | 81.2 | 13720 | 14490 | 14490 | 14140 |
| 5535-1B-421 | 421cm | 87   | 14700 | 15525 | 15525 | 15150 |
| 5535-1B-449 | 449cm | 92.8 | 15680 | 16560 | 16560 | 16160 |

wattage: 20 W/m

Το φωτιστικό είναι διαθέσιμο σε μήκος πολλαπλάσιο των 14 εκατοστών

The illuminant is available in lengths that are multiples of 14 centimeters.

## LENA 55×35 / Lumen output tables

| CATEGORY 2A 350mA (2A) | code        | length | watt  | lumens<br>3000K | lumens<br>4000K | lumens<br>5000K | lumens<br>6500K |
|------------------------|-------------|--------|-------|-----------------|-----------------|-----------------|-----------------|
|                        | 5535-2A-57  | 57cm   | 23.6  | 4080            | 4380            | 4380            | 4080            |
|                        | 5535-2A-85  | 85cm   | 35.4  | 6120            | 6570            | 6570            | 6120            |
|                        | 5535-2A-113 | 113cm  | 47.2  | 8160            | 8760            | 8760            | 8160            |
|                        | 5535-2A-141 | 141cm  | 59    | 10200           | 10950           | 10950           | 10200           |
|                        | 5535-2A-169 | 169cm  | 70.8  | 12240           | 13140           | 13140           | 12240           |
|                        | 5535-2A-197 | 197cm  | 82.6  | 14280           | 15330           | 15330           | 14280           |
|                        | 5535-2A-225 | 225cm  | 94.4  | 16320           | 17520           | 17520           | 16320           |
|                        | 5535-2A-253 | 253cm  | 106.2 | 18360           | 19710           | 19710           | 18360           |
|                        | 5535-2A-281 | 281cm  | 118   | 20400           | 21900           | 21900           | 20400           |
|                        | 5535-2A-309 | 309cm  | 129.8 | 22440           | 24090           | 24090           | 22440           |
|                        | 5535-2A-337 | 337cm  | 141.6 | 24480           | 26280           | 26280           | 24480           |
|                        | 5535-2A-365 | 365cm  | 153.4 | 26520           | 28470           | 28470           | 26520           |
|                        | 5535-2A-393 | 393cm  | 165.2 | 28560           | 30660           | 30660           | 28560           |
|                        | 5535-2A-421 | 421cm  | 177   | 30600           | 32850           | 32850           | 30600           |
| 5535-2A-449            | 449cm       | 188.8  | 32640 | 35040           | 35040           | 32640           |                 |

wattage: 40.5 W/m

|             |       |       |       |       |       |       |
|-------------|-------|-------|-------|-------|-------|-------|
| 5535-2B-57  | 57cm  | 35    | 5700  | 6140  | 6140  | 5700  |
| 5535-2B-85  | 85cm  | 52.5  | 8550  | 9210  | 9210  | 8550  |
| 5535-2B-113 | 113cm | 70    | 11400 | 12280 | 12280 | 11400 |
| 5535-2B-141 | 141cm | 87.5  | 14250 | 15350 | 15350 | 14250 |
| 5535-2B-169 | 169cm | 105   | 17100 | 18420 | 18420 | 17100 |
| 5535-2B-197 | 197cm | 122.5 | 19950 | 21490 | 21490 | 19950 |
| 5535-2B-225 | 225cm | 140   | 22800 | 24560 | 24560 | 22800 |
| 5535-2B-253 | 253cm | 157.5 | 25650 | 27630 | 27630 | 25650 |
| 5535-2B-281 | 281cm | 175   | 28500 | 30700 | 30700 | 28500 |
| 5535-2B-309 | 309cm | 192.5 | 31350 | 33770 | 33770 | 31350 |
| 5535-2B-337 | 337cm | 210   | 34200 | 36840 | 36840 | 34200 |
| 5535-2B-365 | 365cm | 227.5 | 37050 | 39910 | 39910 | 37050 |
| 5535-2B-393 | 393cm | 245   | 39900 | 42980 | 42980 | 39900 |
| 5535-2B-421 | 421cm | 262.5 | 42750 | 46050 | 46050 | 42750 |
| 5535-2B-449 | 449cm | 280   | 45600 | 49120 | 49120 | 45600 |

wattage: 60.5 W/m

Το φωτιστικό είναι διαθέσιμο σε μήκος πολλαπλάσιο των 14 εκατοστών

The illuminant is available in lengths that are multiples of 14 centimeters.

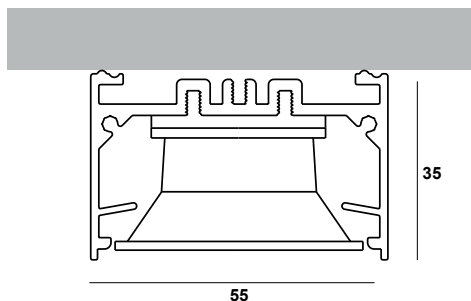

D5535 - XX - XXX - X - XXX - XX - X - X - XXX

| (a)                              | (b)                   | (c)             | (d)  | (e)                        | (f)                                 | (g)                                       | (h)                                       | (i)  |
|----------------------------------|-----------------------|-----------------|--|----------------------------|-------------------------------------|---|---|--|
| Κωδικός Γραμμικού<br>Linear Code | Κατηγορία<br>Category | Μήκος<br>Length | Θερμοκρασία<br>φωτός<br>Color<br>Temperature | Γωνία Δέσμης<br>Beam Angle | Χρώμα<br>προφίλ<br>Profile<br>Color | Χρώμα<br>Ρεφλέκτορα<br>Reflector<br>Color | Αυξομείωση<br>έντασης<br>φωτός<br>Dimming | Τοποθέτηση<br>τροφοδοτικού<br>Power supply<br>installation |



Παράδειγμα κωδικού / Code example

DARK LENA 55×35 1A 87cm 3000K 65° Black with Black Reflector Dimmable (Hidden power supply)

SKU: D5535-1A-87-3-60D-BL-1-D-PS3

| material                     | pcb details          | CRI                      | lumen output / W |
|------------------------------|----------------------|--------------------------|------------------|
| Extruded aluminium / Plastic | SMD light & dark 7×1 | Ra>90 (Ra>80 on request) | up to 205 Lm/W   |

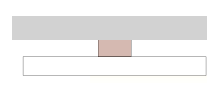
| CCT                           | beam angle       | profile color | reflector color | dimming options (D) |
|-------------------------------|------------------|---------------|-----------------|---------------------|
| 3000K (3)                     | Medium 65° (60D) | Anodised (AN) | Black (1)       | Push                |
| 4000K (4)                     | Wide 90° (90D)   | Black (BL)    | White (2)       | DALI                |
| TUNABLE<br>2700K - 6500K (TN) |                  | White (WH)    |                 | TRIAC 0/1-10V       |
|                               |                  | RAL (RL)      |                 | CASAMBI             |
|                               |                  |               |                 | Analog 0/1-10V      |

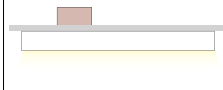
| power supply installation  |  |   |
|--|--|---|
|  <p>Πάνω στο προφίλ με ροζέτα<br/>On the profile with rosette<br/>(-PS1-)</p> |  <p>Δίπλα στο προφίλ<br/>To the side of the profile<br/>(-PS2-)</p> |  <p>Κρυφό με πρόσβαση στο τροφοδοτικό<br/>Hidden with access to the power supply<br/>(-PS3-)</p> |

## DARK LENA 55×35 / Lumen output tables

| CATEGORY 1A 350mA (1A) | code           | length  | watt  | lumens<br>3000K (65°) | lumens<br>3000K (90°) | lumens<br>4000K (65°) | lumens<br>4000K (90°) |
|------------------------|----------------|---------|-------|-----------------------|-----------------------|-----------------------|-----------------------|
|                        | D5535-1A-59    | 59cm    | 13.4  | 1702                  | 1680                  | 1774                  | 1752                  |
|                        | D5535-1A-87    | 87cm    | 20.1  | 2553                  | 2520                  | 2661                  | 2628                  |
|                        | D5535-1A-115   | 115cm   | 26.8  | 3404                  | 3360                  | 3548                  | 3504                  |
|                        | D5535-1A-143   | 143cm   | 33.5  | 4255                  | 4200                  | 4435                  | 4380                  |
|                        | D5535-1A-171   | 171cm   | 40.2  | 5106                  | 5040                  | 5322                  | 5256                  |
|                        | D5535-1A-200.5 | 200.5cm | 46.9  | 5957                  | 5880                  | 6209                  | 6132                  |
|                        | D5535-1A-228.5 | 228.5cm | 53.6  | 6808                  | 6720                  | 7096                  | 7008                  |
|                        | D5535-1A-256.5 | 256.5cm | 60.3  | 7659                  | 7560                  | 7983                  | 7884                  |
|                        | D5535-1A-284.5 | 284.5cm | 67    | 8510                  | 8400                  | 8870                  | 8760                  |
|                        | D5535-1A-312.5 | 312.5cm | 73.7  | 9361                  | 9240                  | 9757                  | 9636                  |
|                        | D5535-1A-340.5 | 340.5cm | 80.4  | 10212                 | 10080                 | 10644                 | 10512                 |
|                        | D5535-1A-368.5 | 368.5cm | 87.1  | 11063                 | 10920                 | 11531                 | 11388                 |
|                        | D5535-1A-396.5 | 396.5cm | 93.8  | 11914                 | 11760                 | 12418                 | 12264                 |
|                        | D5535-1A-424.5 | 424.5cm | 100.5 | 12765                 | 12600                 | 13305                 | 13140                 |
| D5535-1A-452.5         | 452.5cm        | 107.2   | 13616 | 13440                 | 14192                 | 14016                 |                       |

wattage: 23 W/m

|                |         |       |       |       |       |       |
|----------------|---------|-------|-------|-------|-------|-------|
| D5535-1B-59    | 59cm    | 19.8  | 2398  | 2368  | 2512  | 2480  |
| D5535-1B-87    | 87cm    | 29.7  | 3597  | 3552  | 3768  | 3720  |
| D5535-1B-115   | 115cm   | 39.6  | 4796  | 4736  | 5024  | 4960  |
| D5535-1B-143   | 143cm   | 49.5  | 5995  | 5920  | 6280  | 6200  |
| D5535-1B-171   | 171cm   | 59.4  | 7194  | 7104  | 7536  | 7440  |
| D5535-1B-200.5 | 200.5cm | 69.3  | 8393  | 8288  | 8792  | 8680  |
| D5535-1B-228.5 | 228.5cm | 79.2  | 9592  | 9472  | 10048 | 9920  |
| D5535-1B-256.5 | 256.5cm | 89.1  | 10791 | 10656 | 11304 | 11160 |
| D5535-1B-284.5 | 284.5cm | 99    | 11990 | 11840 | 12560 | 12400 |
| D5535-1B-312.5 | 312.5cm | 108.9 | 13189 | 13024 | 13816 | 13640 |
| D5535-1B-340.5 | 340.5cm | 118.8 | 14388 | 14208 | 15072 | 14880 |
| D5535-1B-368.5 | 368.5cm | 128.7 | 15587 | 15392 | 16328 | 16120 |
| D5535-1B-396.5 | 396.5cm | 138.6 | 16786 | 16576 | 17584 | 17360 |
| D5535-1B-424.5 | 424.5cm | 148.5 | 17985 | 17760 | 18840 | 18600 |
| D5535-1B-452.5 | 452.5cm | 158.4 | 19184 | 18944 | 20096 | 19840 |

wattage: 34 W/m

Το φωτιστικό είναι διαθέσιμο σε μήκος πολλαπλάσιο των 28 εκατοστών

The illuminant is available in lengths that are multiples of 28 centimeters.

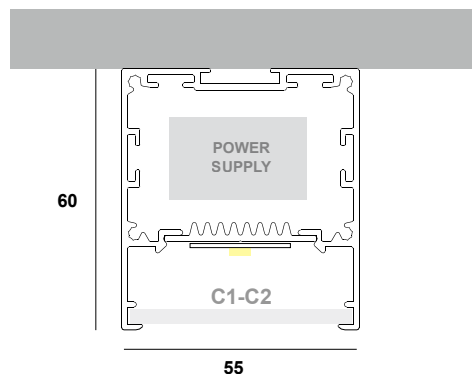

5560 - XX - XXX - X - XX - XX - X



|                                  |                       |                 |  |                |                  |  |
|----------------------------------|-----------------------|-----------------|--|----------------|------------------|--|
| (a)                              | (b)                   | (c)             | (d)  | (e)            | (f)              | (g)                                    |
| Κωδικός Γραμμικού<br>Linear Code | Κατηγορία<br>Category | Μήκος<br>Length | Θερμοκρασία<br>φωτός<br>Color<br>Temperature | Χρώμα<br>Color | Κάλυμμα<br>Cover | Αυξομείωση<br>έντασης φωτός<br>Dimming |

**Παράδειγμα κωδικού / Code example**

GANGES 55×60 85cm 1A 3000K Black with Diffuser Dimmable

SKU: 5560-1A-85-3-BL-C1-D

| material           | pcb details                | CRI                      | lumen output / W |
|--------------------|----------------------------|--------------------------|------------------|
| Extruded aluminium | Zhaga-Compliant Dimensions | Ra>80 (Ra>90 on request) | up to 195 Lm/W   |

| covers   | profile color | CCT                           | dimming options (D) |
|--|---------------|-------------------------------|---------------------|
| Diffuser 3mm<br>(-C1-)        | Anodised (AN) | 3000K (3)                     | Push                |
|  | Black (BL)    | 4000K (4)                     | DALI                |
|  | White (WH)    | 5000K (5)                     | TRIAC 0/1-10V       |
| Microprismatic 3mm<br>(-C2-)  | RAL (RL)      | 6500K (6)                     | CASAMBI             |
|  |               | TUNABLE<br>2700K - 6500K (TN) | Analog 0/1-10V      |

## GANGES 55×60 / Lumen output tables

| CATEGORY 1A 350mA (1A) | code        | length | watt  | lumens 3000K | lumens 4000K | lumens 5000K | lumens 6500K |
|------------------------|-------------|--------|-------|--------------|--------------|--------------|--------------|
|                        | 5560-1A-57  | 57cm   | 7.8   | 1390         | 1470         | 1470         | 1440         |
|                        | 5560-1A-85  | 85cm   | 11.7  | 2085         | 2205         | 2205         | 2160         |
|                        | 5560-1A-113 | 113cm  | 15.6  | 2780         | 2940         | 2940         | 2880         |
|                        | 5560-1A-141 | 141cm  | 19.5  | 3475         | 3675         | 3675         | 3600         |
|                        | 5560-1A-169 | 169cm  | 23.4  | 4170         | 4410         | 4410         | 4320         |
|                        | 5560-1A-197 | 197cm  | 27.3  | 4865         | 5145         | 5145         | 5040         |
|                        | 5560-1A-225 | 225cm  | 31.2  | 5560         | 5880         | 5880         | 5760         |
|                        | 5560-1A-253 | 253cm  | 35.1  | 6255         | 6615         | 6615         | 6480         |
|                        | 5560-1A-281 | 281cm  | 39    | 6950         | 7350         | 7350         | 7200         |
|                        | 5560-1A-309 | 309cm  | 42.9  | 7645         | 8085         | 8085         | 7920         |
|                        | 5560-1A-337 | 337cm  | 46.8  | 8340         | 8820         | 8820         | 8640         |
|                        | 5560-1A-365 | 365cm  | 50.7  | 9035         | 9555         | 9555         | 9360         |
|                        | 5560-1A-393 | 393cm  | 54.6  | 9730         | 10290        | 10290        | 10080        |
|                        | 5560-1A-421 | 421cm  | 58.5  | 10425        | 11025        | 11025        | 10800        |
| 5560-1A-449            | 449cm       | 62.4   | 11120 | 11760        | 11760        | 11520        |              |

wattage: 13.5 W/m

|             |       |      |       |       |       |       |
|-------------|-------|------|-------|-------|-------|-------|
| 5560-1B-57  | 57cm  | 11.6 | 1960  | 2070  | 2070  | 2020  |
| 5560-1B-85  | 85cm  | 17.4 | 2940  | 3105  | 3105  | 3030  |
| 5560-1B-113 | 113cm | 23.2 | 3920  | 4140  | 4140  | 4040  |
| 5560-1B-141 | 141cm | 29   | 4900  | 5175  | 5175  | 5050  |
| 5560-1B-169 | 169cm | 34.8 | 5880  | 6210  | 6210  | 6060  |
| 5560-1B-197 | 197cm | 40.6 | 6860  | 7245  | 7245  | 7070  |
| 5560-1B-225 | 225cm | 46.4 | 7840  | 8280  | 8280  | 8080  |
| 5560-1B-253 | 253cm | 52.2 | 8820  | 9315  | 9315  | 9090  |
| 5560-1B-281 | 281cm | 58   | 9800  | 10350 | 10350 | 10100 |
| 5560-1B-309 | 309cm | 63.8 | 10780 | 11385 | 11385 | 11110 |
| 5560-1B-337 | 337cm | 69.6 | 11760 | 12420 | 12420 | 12120 |
| 5560-1B-365 | 365cm | 75.4 | 12740 | 13455 | 13455 | 13130 |
| 5560-1B-393 | 393cm | 81.2 | 13720 | 14490 | 14490 | 14140 |
| 5560-1B-421 | 421cm | 87   | 14700 | 15525 | 15525 | 15150 |
| 5560-1B-449 | 449cm | 92.8 | 15680 | 16560 | 16560 | 16160 |

wattage: 20 W/m

Το φωτιστικό είναι διαθέσιμο σε μήκος πολλαπλάσιο των 14 εκατοστών

The illuminant is available in lengths that are multiples of 14 centimeters.



**GANGES 55×60 / Lumen output tables**

|                        | code        | length | watt  | lumens<br>3000K | lumens<br>4000K | lumens<br>5000K | lumens<br>6500K |
|------------------------|-------------|--------|-------|-----------------|-----------------|-----------------|-----------------|
| CATEGORY 2A 350mA (2A) | 5560-2A-57  | 57cm   | 23.6  | 4080            | 4380            | 4380            | 4080            |
|                        | 5560-2A-85  | 85cm   | 35.4  | 6120            | 6570            | 6570            | 6120            |
|                        | 5560-2A-113 | 113cm  | 47.2  | 8160            | 8760            | 8760            | 8160            |
|                        | 5560-2A-141 | 141cm  | 59    | 10200           | 10950           | 10950           | 10200           |
|                        | 5560-2A-169 | 169cm  | 70.8  | 12240           | 13140           | 13140           | 12240           |
|                        | 5560-2A-197 | 197cm  | 82.6  | 14280           | 15330           | 15330           | 14280           |
|                        | 5560-2A-225 | 225cm  | 94.4  | 16320           | 17520           | 17520           | 16320           |
|                        | 5560-2A-253 | 253cm  | 106.2 | 18360           | 19710           | 19710           | 18360           |
|                        | 5560-2A-281 | 281cm  | 118   | 20400           | 21900           | 21900           | 20400           |
|                        | 5560-2A-309 | 309cm  | 129.8 | 22440           | 24090           | 24090           | 22440           |
|                        | 5560-2A-337 | 337cm  | 141.6 | 24480           | 26280           | 26280           | 24480           |
|                        | 5560-2A-365 | 365cm  | 153.4 | 26520           | 28470           | 28470           | 26520           |
|                        | 5560-2A-393 | 393cm  | 165.2 | 28560           | 30660           | 30660           | 28560           |
|                        | 5560-2A-421 | 421cm  | 177   | 30600           | 32850           | 32850           | 30600           |
|                        | 5560-2A-449 | 449cm  | 188.8 | 32640           | 35040           | 35040           | 32640           |

wattage: 40.5 W/m

|                        |             |       |       |       |       |       |       |
|------------------------|-------------|-------|-------|-------|-------|-------|-------|
| CATEGORY 2B 500mA (2B) | 5560-2B-57  | 57cm  | 35    | 5700  | 6140  | 6140  | 5700  |
|                        | 5560-2B-85  | 85cm  | 52.5  | 8550  | 9210  | 9210  | 8550  |
|                        | 5560-2B-113 | 113cm | 70    | 11400 | 12280 | 12280 | 11400 |
|                        | 5560-2B-141 | 141cm | 87.5  | 14250 | 15350 | 15350 | 14250 |
|                        | 5560-2B-169 | 169cm | 105   | 17100 | 18420 | 18420 | 17100 |
|                        | 5560-2B-197 | 197cm | 122.5 | 19950 | 21490 | 21490 | 19950 |
|                        | 5560-2B-225 | 225cm | 140   | 22800 | 24560 | 24560 | 22800 |
|                        | 5560-2B-253 | 253cm | 157.5 | 25650 | 27630 | 27630 | 25650 |
|                        | 5560-2B-281 | 281cm | 175   | 28500 | 30700 | 30700 | 28500 |
|                        | 5560-2B-309 | 309cm | 192.5 | 31350 | 33770 | 33770 | 31350 |
|                        | 5560-2B-337 | 337cm | 210   | 34200 | 36840 | 36840 | 34200 |
|                        | 5560-2B-365 | 365cm | 227.5 | 37050 | 39910 | 39910 | 37050 |
|                        | 5560-2B-393 | 393cm | 245   | 39900 | 42980 | 42980 | 39900 |
|                        | 5560-2B-421 | 421cm | 262.5 | 42750 | 46050 | 46050 | 42750 |
|                        | 5560-2B-449 | 449cm | 280   | 45600 | 49120 | 49120 | 45600 |

wattage: 60.5 W/m

*Το φωτιστικό είναι διαθέσιμο σε μήκος πολλαπλάσιο των 14 εκατοστών*

*The illuminant is available in lengths that are multiples of 14 centimeters.*



SURFACE MOUNTED

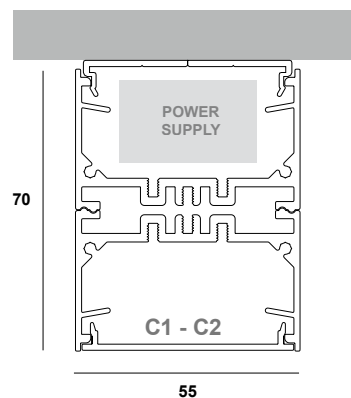

5570 - XX - XXX - X - XX - XX - X

- (a)  
Κωδικός Γραμμικού  
Linear Code
- (b)  
Κατηγορία  
Category
- (c)  
Μήκος  
Length
- (d)  
Θερμοκρασία  
φωτός  
Color  
Temperature
- (e)  
Χρώμα  
προφίλ  
Profile  
color
- (f)  
Κάλυμμα  
Cover
- (g)  
Αυξομείωση  
έντασης φωτός  
Dimming

**Παράδειγμα κωδικού / Code example**

LINEAR 55×70 87cm 1A 3000K Black with Diffuser Dimmable

SKU: 5570-1A-87-3-BL-C1-D

| material           | pcb details                | CRI                      | lumen output / W |
|--------------------|----------------------------|--------------------------|------------------|
| Extruded aluminium | Zhaga-Compliant Dimensions | Ra>80 (Ra>90 on request) | up to 195 Lm/W   |

| covers                        | profile color | CCT                           | dimming options (D) |
|-------------------------------|---------------|-------------------------------|---------------------|
| Acrylic Diffuser (-C1-)       | Anodised (AN) | 3000K (3)                     | Push                |
|                               | Black (BL)    | 4000K (4)                     | DALI                |
|                               | White (WH)    | 5000K (5)                     | TRIAC 0/1-10V       |
| Acrylic Microprismatic (-C2-) | RAL (RL)      | 6500K (6)                     | CASAMBI             |
|                               |               | TUNABLE<br>2700K - 6500K (TN) | Analog 0/1-10V      |



## LINEAR 55×70 / Lumen output tables

| CATEGORY 1A 350mA (1A) | code        | length | watt  | lumens 3000K | lumens 4000K | lumens 5000K | lumens 6500K |
|------------------------|-------------|--------|-------|--------------|--------------|--------------|--------------|
|                        | 5570-1A-57  | 57cm   | 7.8   | 1390         | 1470         | 1470         | 1440         |
|                        | 5570-1A-85  | 85cm   | 11.7  | 2085         | 2205         | 2205         | 2160         |
|                        | 5570-1A-113 | 113cm  | 15.6  | 2780         | 2940         | 2940         | 2880         |
|                        | 5570-1A-141 | 141cm  | 19.5  | 3475         | 3675         | 3675         | 3600         |
|                        | 5570-1A-169 | 169cm  | 23.4  | 4170         | 4410         | 4410         | 4320         |
|                        | 5570-1A-197 | 197cm  | 27.3  | 4865         | 5145         | 5145         | 5040         |
|                        | 5570-1A-225 | 225cm  | 31.2  | 5560         | 5880         | 5880         | 5760         |
|                        | 5570-1A-253 | 253cm  | 35.1  | 6255         | 6615         | 6615         | 6480         |
|                        | 5570-1A-281 | 281cm  | 39    | 6950         | 7350         | 7350         | 7200         |
|                        | 5570-1A-309 | 309cm  | 42.9  | 7645         | 8085         | 8085         | 7920         |
|                        | 5570-1A-337 | 337cm  | 46.8  | 8340         | 8820         | 8820         | 8640         |
|                        | 5570-1A-365 | 365cm  | 50.7  | 9035         | 9555         | 9555         | 9360         |
|                        | 5570-1A-393 | 393cm  | 54.6  | 9730         | 10290        | 10290        | 10080        |
|                        | 5570-1A-421 | 421cm  | 58.5  | 10425        | 11025        | 11025        | 10800        |
| 5570-1A-449            | 449cm       | 62.4   | 11120 | 11760        | 11760        | 11520        |              |

wattage: 13.5 W/m

|             |       |      |       |       |       |       |
|-------------|-------|------|-------|-------|-------|-------|
| 5570-1B-57  | 57cm  | 11.6 | 1960  | 2070  | 2070  | 2020  |
| 5570-1B-85  | 85cm  | 17.4 | 2940  | 3105  | 3105  | 3030  |
| 5570-1B-113 | 113cm | 23.2 | 3920  | 4140  | 4140  | 4040  |
| 5570-1B-141 | 141cm | 29   | 4900  | 5175  | 5175  | 5050  |
| 5570-1B-169 | 169cm | 34.8 | 5880  | 6210  | 6210  | 6060  |
| 5570-1B-197 | 197cm | 40.6 | 6860  | 7245  | 7245  | 7070  |
| 5570-1B-225 | 225cm | 46.4 | 7840  | 8280  | 8280  | 8080  |
| 5570-1B-253 | 253cm | 52.2 | 8820  | 9315  | 9315  | 9090  |
| 5570-1B-281 | 281cm | 58   | 9800  | 10350 | 10350 | 10100 |
| 5570-1B-309 | 309cm | 63.8 | 10780 | 11385 | 11385 | 11110 |
| 5570-1B-337 | 337cm | 69.6 | 11760 | 12420 | 12420 | 12120 |
| 5570-1B-365 | 365cm | 75.4 | 12740 | 13455 | 13455 | 13130 |
| 5570-1B-393 | 393cm | 81.2 | 13720 | 14490 | 14490 | 14140 |
| 5570-1B-421 | 421cm | 87   | 14700 | 15525 | 15525 | 15150 |
| 5570-1B-449 | 449cm | 92.8 | 15680 | 16560 | 16560 | 16160 |

wattage: 20 W/m

Το φωτιστικό είναι διαθέσιμο σε μήκος πολλαπλάσιο των 14 εκατοστών

The illuminant is available in lengths that are multiples of 14 centimeters.

## LINEAR 55×70 / Lumen output tables

|                        | code        | length | watt  | lumens<br>3000K | lumens<br>4000K | lumens<br>5000K | lumens<br>6500K |
|------------------------|-------------|--------|-------|-----------------|-----------------|-----------------|-----------------|
| CATEGORY 2A 350mA (2A) | 5570-2A-57  | 57cm   | 23.6  | 4080            | 4380            | 4380            | 4080            |
|                        | 5570-2A-85  | 85cm   | 35.4  | 6120            | 6570            | 6570            | 6120            |
|                        | 5570-2A-113 | 113cm  | 47.2  | 8160            | 8760            | 8760            | 8160            |
|                        | 5570-2A-141 | 141cm  | 59    | 10200           | 10950           | 10950           | 10200           |
|                        | 5570-2A-169 | 169cm  | 70.8  | 12240           | 13140           | 13140           | 12240           |
|                        | 5570-2A-197 | 197cm  | 82.6  | 14280           | 15330           | 15330           | 14280           |
|                        | 5570-2A-225 | 225cm  | 94.4  | 16320           | 17520           | 17520           | 16320           |
|                        | 5570-2A-253 | 253cm  | 106.2 | 18360           | 19710           | 19710           | 18360           |
|                        | 5570-2A-281 | 281cm  | 118   | 20400           | 21900           | 21900           | 20400           |
|                        | 5570-2A-309 | 309cm  | 129.8 | 22440           | 24090           | 24090           | 22440           |
|                        | 5570-2A-337 | 337cm  | 141.6 | 24480           | 26280           | 26280           | 24480           |
|                        | 5570-2A-365 | 365cm  | 153.4 | 26520           | 28470           | 28470           | 26520           |
|                        | 5570-2A-393 | 393cm  | 165.2 | 28560           | 30660           | 30660           | 28560           |
|                        | 5570-2A-421 | 421cm  | 177   | 30600           | 32850           | 32850           | 30600           |
|                        | 5570-2A-449 | 449cm  | 188.8 | 32640           | 35040           | 35040           | 32640           |

wattage: 40.5 W/m

|                        |             |       |       |       |       |       |       |
|------------------------|-------------|-------|-------|-------|-------|-------|-------|
| CATEGORY 2B 500mA (2B) | 5570-2B-57  | 57cm  | 35    | 5700  | 6140  | 6140  | 5700  |
|                        | 5570-2B-85  | 85cm  | 52.5  | 8550  | 9210  | 9210  | 8550  |
|                        | 5570-2B-113 | 113cm | 70    | 11400 | 12280 | 12280 | 11400 |
|                        | 5570-2B-141 | 141cm | 87.5  | 14250 | 15350 | 15350 | 14250 |
|                        | 5570-2B-169 | 169cm | 105   | 17100 | 18420 | 18420 | 17100 |
|                        | 5570-2B-197 | 197cm | 122.5 | 19950 | 21490 | 21490 | 19950 |
|                        | 5570-2B-225 | 225cm | 140   | 22800 | 24560 | 24560 | 22800 |
|                        | 5570-2B-253 | 253cm | 157.5 | 25650 | 27630 | 27630 | 25650 |
|                        | 5570-2B-281 | 281cm | 175   | 28500 | 30700 | 30700 | 28500 |
|                        | 5570-2B-309 | 309cm | 192.5 | 31350 | 33770 | 33770 | 31350 |
|                        | 5570-2B-337 | 337cm | 210   | 34200 | 36840 | 36840 | 34200 |
|                        | 5570-2B-365 | 365cm | 227.5 | 37050 | 39910 | 39910 | 37050 |
|                        | 5570-2B-393 | 393cm | 245   | 39900 | 42980 | 42980 | 39900 |
|                        | 5570-2B-421 | 421cm | 262.5 | 42750 | 46050 | 46050 | 42750 |
|                        | 5570-2B-449 | 449cm | 280   | 45600 | 49120 | 49120 | 45600 |

wattage: 60.5 W/m

Το φωτιστικό είναι διαθέσιμο σε μήκος πολλαπλάσιο των 14 εκατοστών

The illuminant is available in lengths that are multiples of 14 centimeters.

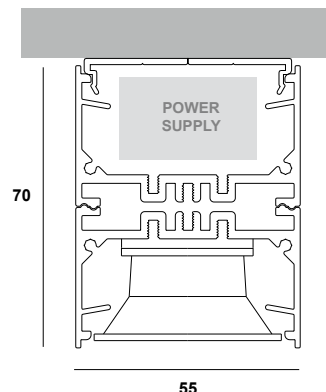

D5570 - XX - XXX - X - XXX - XX - X - X

| (a)                              | (b)                   | (c)             | (d)  | (e)                        | (f)                                 | (g)                                       | (h)                                       |
|----------------------------------|-----------------------|-----------------|--|----------------------------|-------------------------------------|---|---|
| Κωδικός Γραμμικού<br>Linear Code | Κατηγορία<br>Category | Μήκος<br>Length | Θερμοκρασία<br>φωτός<br>Color<br>Temperature | Γωνία Δέσμης<br>Beam Angle | Χρώμα<br>προφίλ<br>Profile<br>Color | Χρώμα<br>Ρεφλέκτορα<br>Reflector<br>Color | Αυξομείωση<br>έντασης<br>φωτός<br>Dimming |

**Παράδειγμα κωδικού / Code example**

DARK LINEAR 55×70 1A 84.5cm 3000K 65° Black with Black Reflector Dimmable

SKU: D5570-1A-85-3-60D-BL-1-D

| material                     | pcb details          | CRI                                 | lumen output / W |
|------------------------------|----------------------|-------------------------------------|------------------|
| Extruded aluminium / Plastic | SMD light & dark 7×1 | Ra>90 ( <b>Ra&gt;80</b> on request) | up to 205 Lm/W   |

| CCT                           | beam angle       | profile color | reflector color | dimming options (D) |
|-------------------------------|------------------|---------------|-----------------|---------------------|
| 3000K (3)                     | Medium 65° (60D) | Anodised (AN) | Black (1)       | Push                |
| 4000K (4)                     | Wide 90° (90D)   | Black (BL)    | White (2)       | DALI                |
| TUNABLE<br>2700K - 6500K (TN) |                  | White (WH)    |                 | TRIAC 0/1-10V       |
|                               |                  | RAL (RL)      |                 | CASAMBI             |
|                               |                  |               |                 | Analog 0/1-10V      |

## DARK LINEAR 55×70 / Lumen output tables

| CATEGORY 1A 350mA (1A) | code           | length  | watt  | lumens<br>3000K (65°) | lumens<br>3000K (90°) | lumens<br>4000K (65°) | lumens<br>4000K (90°) |
|------------------------|----------------|---------|-------|-----------------------|-----------------------|-----------------------|-----------------------|
|                        | D5570-1A-56.5  | 56.5cm  | 13.4  | 1702                  | 1680                  | 1774                  | 1752                  |
|                        | D5570-1A-84.5  | 84.5cm  | 20.1  | 2553                  | 2520                  | 2661                  | 2628                  |
|                        | D5570-1A-112.5 | 112.5cm | 26.8  | 3404                  | 3360                  | 3548                  | 3504                  |
|                        | D5570-1A-140.5 | 140.5cm | 33.5  | 4255                  | 4200                  | 4435                  | 4380                  |
|                        | D5570-1A-168.5 | 168.5cm | 40.2  | 5106                  | 5040                  | 5322                  | 5256                  |
|                        | D5570-1A-196.5 | 196.5cm | 46.9  | 5957                  | 5880                  | 6209                  | 6132                  |
|                        | D5570-1A-224.5 | 224.5cm | 53.6  | 6808                  | 6720                  | 7096                  | 7008                  |
|                        | D5570-1A-252.5 | 252.5cm | 60.3  | 7659                  | 7560                  | 7983                  | 7884                  |
|                        | D5570-1A-280.5 | 280.5cm | 67    | 8510                  | 8400                  | 8870                  | 8760                  |
|                        | D5570-1A-308.5 | 308.5cm | 73.7  | 9361                  | 9240                  | 9757                  | 9636                  |
|                        | D5570-1A-336.5 | 336.5cm | 80.4  | 10212                 | 10080                 | 10644                 | 10512                 |
|                        | D5570-1A-364.5 | 364.5cm | 87.1  | 11063                 | 10920                 | 11531                 | 11388                 |
|                        | D5570-1A-392.5 | 392.5cm | 93.8  | 11914                 | 11760                 | 12418                 | 12264                 |
|                        | D5570-1A-420.5 | 420.5cm | 100.5 | 12765                 | 12600                 | 13305                 | 13140                 |
| D5570-1A-448.5         | 448.5cm        | 107.2   | 13616 | 13440                 | 14192                 | 14016                 |                       |

wattage: 23 W/m

| CATEGORY 1B 500mA (1B) | D5570-1B-56.5  | 56.5cm  | 19.8  | 2398  | 2368  | 2512  | 2480  |
|------------------------|----------------|---------|-------|-------|-------|-------|-------|
|                        | D5570-1B-84.5  | 84.5cm  | 29.7  | 3597  | 3552  | 3768  | 3720  |
|                        | D5570-1B-112.5 | 112.5cm | 39.6  | 4796  | 4736  | 5024  | 4960  |
|                        | D5570-1B-140.5 | 140.5cm | 49.5  | 5995  | 5920  | 6280  | 6200  |
|                        | D5570-1B-168.5 | 168.5cm | 59.4  | 7194  | 7104  | 7536  | 7440  |
|                        | D5570-1B-196.5 | 196.5cm | 69.3  | 8393  | 8288  | 8792  | 8680  |
|                        | D5570-1B-224.5 | 224.5cm | 79.2  | 9592  | 9472  | 10048 | 9920  |
|                        | D5570-1B-252.5 | 252.5cm | 89.1  | 10791 | 10656 | 11304 | 11160 |
|                        | D5570-1B-280.5 | 280.5cm | 99    | 11990 | 11840 | 12560 | 12400 |
|                        | D5570-1B-308.5 | 308.5cm | 108.9 | 13189 | 13024 | 13816 | 13640 |
|                        | D5570-1B-336.5 | 336.5cm | 118.8 | 14388 | 14208 | 15072 | 14880 |
|                        | D5570-1B-364.5 | 364.5cm | 128.7 | 15587 | 15392 | 16328 | 16120 |
|                        | D5570-1B-392.5 | 392.5cm | 138.6 | 16786 | 16576 | 17584 | 17360 |
|                        | D5570-1B-420.5 | 420.5cm | 148.5 | 17985 | 17760 | 18840 | 18600 |
|                        | D5570-1B-448.5 | 448.5cm | 158.4 | 19184 | 18944 | 20096 | 19840 |

wattage: 34 W/m

Το φωτιστικό είναι διαθέσιμο σε μήκος πολλαπλάσιο των 28 εκατοστών

The illuminant is available in lengths that are multiples of 28 centimeters.



SURFACE MOUNTED



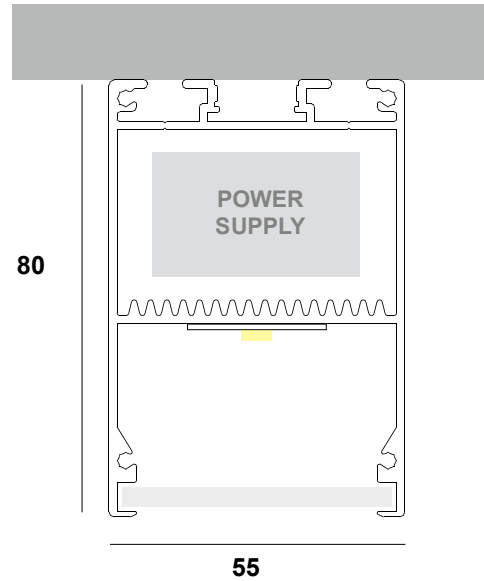



5580 - XX - XXX - X - XX - XX - X

| (a)                              | (b)                   | (c)             | (d)  | (e)                                 | (f)              | (g)                                    |
|----------------------------------|-----------------------|-----------------|--|-------------------------------------|------------------|--|
| Κωδικός Γραμμικού<br>Linear Code | Κατηγορία<br>Category | Μήκος<br>Length | Θερμοκρασία<br>φωτός<br>Color<br>Temperature | Χρώμα<br>προφίλ<br>Profile<br>color | Κάλυμμα<br>Cover | Αυξομείωση<br>έντασης φωτός<br>Dimming |

**Παράδειγμα κωδικού / Code example**

NILE 55×80 88cm 1A 3000K Black with Diffuser Dimmable  
**SKU:** 5580-1A-88-3-BL-C1-D

| material           | pcb details                | CRI                                 | lumen output / W |
|--------------------|----------------------------|-------------------------------------|------------------|
| Extruded aluminium | Zhaga-Compliant Dimensions | Ra>80 ( <b>Ra&gt;90</b> on request) | up to 195 Lm/W   |

| covers  | profile color          | CCT                                    | dimming options (D) |
|---|------------------------|--|---------------------|
| Acrylic Diffuser<br>(-C1-)<br>       | Anodised ( <b>AN</b> ) | 3000K ( <b>3</b> )                     | Push                |
|   | Black ( <b>BL</b> )    | 4000K ( <b>4</b> )                     | DALI                |
|   | White ( <b>WH</b> )    | 5000K ( <b>5</b> )                     | TRIAC 0/1-10V       |
| Acrylic Microprismatic<br>(-C2-)<br> | RAL ( <b>RL</b> )      | 6500K ( <b>6</b> )                     | CASAMBI             |
|   |                        | TUNABLE<br>2700K - 6500K ( <b>TN</b> ) | Analog 0/1-10V      |

## NILE 55×80 / Lumen output tables

| CATEGORY 1A 350mA (1A) | code        | length | watt  | lumens 3000K | lumens 4000K | lumens 5000K | lumens 6500K |
|------------------------|-------------|--------|-------|--------------|--------------|--------------|--------------|
|                        | 5580-1A-60  | 60cm   | 7.8   | 1390         | 1470         | 1470         | 1440         |
|                        | 5580-1A-88  | 88cm   | 11.7  | 2085         | 2205         | 2205         | 2160         |
|                        | 5580-1A-116 | 116cm  | 15.6  | 2780         | 2940         | 2940         | 2880         |
|                        | 5580-1A-144 | 144cm  | 19.5  | 3475         | 3675         | 3675         | 3600         |
|                        | 5580-1A-172 | 172cm  | 23.4  | 4170         | 4410         | 4410         | 4320         |
|                        | 5580-1A-200 | 200cm  | 27.3  | 4865         | 5145         | 5145         | 5040         |
|                        | 5580-1A-228 | 228cm  | 31.2  | 5560         | 5880         | 5880         | 5760         |
|                        | 5580-1A-256 | 256cm  | 35.1  | 6255         | 6615         | 6615         | 6480         |
|                        | 5580-1A-284 | 284cm  | 39    | 6950         | 7350         | 7350         | 7200         |
|                        | 5580-1A-312 | 312cm  | 42.9  | 7645         | 8085         | 8085         | 7920         |
|                        | 5580-1A-340 | 340cm  | 46.8  | 8340         | 8820         | 8820         | 8640         |
|                        | 5580-1A-368 | 368cm  | 50.7  | 9035         | 9555         | 9555         | 9360         |
|                        | 5580-1A-396 | 396cm  | 54.6  | 9730         | 10290        | 10290        | 10080        |
|                        | 5580-1A-424 | 424cm  | 58.5  | 10425        | 11025        | 11025        | 10800        |
| 5580-1A-452            | 452cm       | 62.4   | 11120 | 11760        | 11760        | 11520        |              |

wattage: 13.5 W/m

|             |       |      |       |       |       |       |
|-------------|-------|------|-------|-------|-------|-------|
| 5580-1B-60  | 60cm  | 11.6 | 1960  | 2070  | 2070  | 2020  |
| 5580-1B-88  | 88cm  | 17.4 | 2940  | 3105  | 3105  | 3030  |
| 5580-1B-116 | 116cm | 23.2 | 3920  | 4140  | 4140  | 4040  |
| 5580-1B-144 | 144cm | 29   | 4900  | 5175  | 5175  | 5050  |
| 5580-1B-172 | 172cm | 34.8 | 5880  | 6210  | 6210  | 6060  |
| 5580-1B-200 | 200cm | 40.6 | 6860  | 7245  | 7245  | 7070  |
| 5580-1B-228 | 228cm | 46.4 | 7840  | 8280  | 8280  | 8080  |
| 5580-1B-256 | 256cm | 52.2 | 8820  | 9315  | 9315  | 9090  |
| 5580-1B-284 | 284cm | 58   | 9800  | 10350 | 10350 | 10100 |
| 5580-1B-312 | 312cm | 63.8 | 10780 | 11385 | 11385 | 11110 |
| 5580-1B-340 | 340cm | 69.6 | 11760 | 12420 | 12420 | 12120 |
| 5580-1B-368 | 368cm | 75.4 | 12740 | 13455 | 13455 | 13130 |
| 5580-1B-396 | 396cm | 81.2 | 13720 | 14490 | 14490 | 14140 |
| 5580-1B-424 | 424cm | 87   | 14700 | 15525 | 15525 | 15150 |
| 5580-1B-452 | 452cm | 92.8 | 15680 | 16560 | 16560 | 16160 |

wattage: 20 W/m

Το φωτιστικό είναι διαθέσιμο σε μήκος πολλαπλάσιο των 14 εκατοστών

The illuminant is available in lengths that are multiples of 14 centimeters.

## NILE 55×80 / Lumen output tables

| CATEGORY 2A 350mA (2A) | code        | length | watt  | lumens 3000K | lumens 4000K | lumens 5000K | lumens 6500K |
|------------------------|-------------|--------|-------|--------------|--------------|--------------|--------------|
|                        | 5580-2A-60  | 60cm   | 23.6  | 4080         | 4380         | 4380         | 4080         |
|                        | 5580-2A-88  | 88cm   | 35.4  | 6120         | 6570         | 6570         | 6120         |
|                        | 5580-2A-116 | 116cm  | 47.2  | 8160         | 8760         | 8760         | 8160         |
|                        | 5580-2A-144 | 144cm  | 59    | 10200        | 10950        | 10950        | 10200        |
|                        | 5580-2A-172 | 172cm  | 70.8  | 12240        | 13140        | 13140        | 12240        |
|                        | 5580-2A-200 | 200cm  | 82.6  | 14280        | 15330        | 15330        | 14280        |
|                        | 5580-2A-228 | 228cm  | 94.4  | 16320        | 17520        | 17520        | 16320        |
|                        | 5580-2A-256 | 256cm  | 106.2 | 18360        | 19710        | 19710        | 18360        |
|                        | 5580-2A-284 | 284cm  | 118   | 20400        | 21900        | 21900        | 20400        |
|                        | 5580-2A-312 | 312cm  | 129.8 | 22440        | 24090        | 24090        | 22440        |
|                        | 5580-2A-340 | 340cm  | 141.6 | 24480        | 26280        | 26280        | 24480        |
|                        | 5580-2A-368 | 368cm  | 153.4 | 26520        | 28470        | 28470        | 26520        |
|                        | 5580-2A-396 | 396cm  | 165.2 | 28560        | 30660        | 30660        | 28560        |
|                        | 5580-2A-424 | 424cm  | 177   | 30600        | 32850        | 32850        | 30600        |
| 5580-2A-452            | 452cm       | 188.8  | 32640 | 35040        | 35040        | 32640        |              |

wattage: 40.5 W/m

|             |       |       |       |       |       |       |
|-------------|-------|-------|-------|-------|-------|-------|
| 5580-2B-60  | 60cm  | 35    | 5700  | 6140  | 6140  | 5700  |
| 5580-2B-88  | 88cm  | 52.5  | 8550  | 9210  | 9210  | 8550  |
| 5580-2B-116 | 116cm | 70    | 11400 | 12280 | 12280 | 11400 |
| 5580-2B-144 | 144cm | 87.5  | 14250 | 15350 | 15350 | 14250 |
| 5580-2B-172 | 172cm | 105   | 17100 | 18420 | 18420 | 17100 |
| 5580-2B-200 | 200cm | 122.5 | 19950 | 21490 | 21490 | 19950 |
| 5580-2B-228 | 228cm | 140   | 22800 | 24560 | 24560 | 22800 |
| 5580-2B-256 | 256cm | 157.5 | 25650 | 27630 | 27630 | 25650 |
| 5580-2B-284 | 284cm | 175   | 28500 | 30700 | 30700 | 28500 |
| 5580-2B-312 | 312cm | 192.5 | 31350 | 33770 | 33770 | 31350 |
| 5580-2B-340 | 340cm | 210   | 34200 | 36840 | 36840 | 34200 |
| 5580-2B-368 | 368cm | 227.5 | 37050 | 39910 | 39910 | 37050 |
| 5580-2B-396 | 396cm | 245   | 39900 | 42980 | 42980 | 39900 |
| 5580-2B-424 | 424cm | 262.5 | 42750 | 46050 | 46050 | 42750 |
| 5580-2B-452 | 452cm | 280   | 45600 | 49120 | 49120 | 45600 |

wattage: 60.5 W/m

Το φωτιστικό είναι διαθέσιμο σε μήκος πολλαπλάσιο των 14 εκατοστών

The illuminant is available in lengths that are multiples of 14 centimeters.



SURFACE MOUNTED



ΚΡΕΜΑΣΤΑ / SUSPENDED

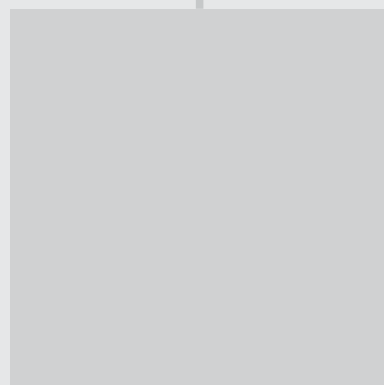

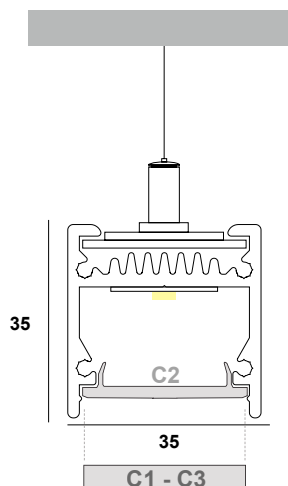

S35 - XX - XXX - X - XX - XX - X - XXX

|                                  |                       |                 |  |                               |                  |                                     |  |
|----------------------------------|-----------------------|-----------------|--|-------------------------------|------------------|-------------------------------------|--|
| (a)                              | (b)                   | (c)             | (d)                                    | (e)                           | (f)              | (g)                                 | (h)  |
| Κωδικός Γραμμικού<br>Linear Code | Κατηγορία<br>Category | Μήκος<br>Length | Θερμοκρασία φωτός<br>Color Temperature | Χρώμα προφίλ<br>Profile color | Κάλυμμα<br>Cover | Αυξομείωση έντασης φωτός<br>Dimming | Τοποθέτηση τροφοδοτικού<br>Power supply installation |

Παράδειγμα κωδικού / Code example

GILA 35×35 SUSPENDED 87cm 1A 3000K Black Dimmable with Slide Diffuser 1.5mm (Hidden power supply)  
SKU: S35-1A-87-3-C2-D-PS2

| material           | pcb details                | CRI                      | lumen output / W |
|--------------------|----------------------------|--------------------------|------------------|
| Extruded aluminium | Zhaga-Compliant Dimensions | Ra>80 (Ra>90 on request) | up to 195 Lm/W   |

| covers                                       | profile color | CCT                        | dimming options (D) |
|--|---------------|----------------------------|---------------------|
| Slide Diffuser 5mm (-C1-)                    | Anodised (AN) | 3000K (3)                  | Push                |
|  | Black (BL)    | 4000K (4)                  | DALI                |
|  | White (WH)    | 5000K (5)                  | TRIAC 0/1-10V       |
| Click diffuser 1.5mm (up to 70m reel) (-C2-) | RAL (RL)      | 6500K (6)                  | CASAMBI             |
|  |               | TUNABLE 2700K - 6500K (TN) | Analog 0/1-10V      |
| Microprismatic (-C3-)                        |               |                            |                     |

| power supply installation                                    |  |
|--|--|
| Σε ροζέτα στην οροφή<br>In rosette on the ceiling<br>(-PS1-) | Κρυφό με πρόσβαση στο τροφοδοτικό<br>Hidden with access to the power supply<br>(-PS2-) |



SUSPENDED



## GILA 35×35 SUSPENDED / Lumen output tables

|                        | code       | length | watt | lumens<br>3000K | lumens<br>4000K | lumens<br>5000K | lumens<br>6500K |
|------------------------|------------|--------|------|-----------------|-----------------|-----------------|-----------------|
| CATEGORY 1A 350mA (1A) | S35-1A-59  | 59cm   | 7.8  | 1390            | 1470            | 1470            | 1440            |
|                        | S35-1A-87  | 87cm   | 11.7 | 2085            | 2205            | 2205            | 2160            |
|                        | S35-1A-115 | 115cm  | 15.6 | 2780            | 2940            | 2940            | 2880            |
|                        | S35-1A-143 | 143cm  | 19.5 | 3475            | 3675            | 3675            | 3600            |
|                        | S35-1A-171 | 171cm  | 23.4 | 4170            | 4410            | 4410            | 4320            |
|                        | S35-1A-199 | 199cm  | 27.3 | 4865            | 5145            | 5145            | 5040            |
|                        | S35-1A-227 | 227cm  | 31.2 | 5560            | 5880            | 5880            | 5760            |
|                        | S35-1A-255 | 255cm  | 35.1 | 6255            | 6615            | 6615            | 6480            |
|                        | S35-1A-283 | 283cm  | 39   | 6950            | 7350            | 7350            | 7200            |
|                        | S35-1A-311 | 311cm  | 42.9 | 7645            | 8085            | 8085            | 7920            |
|                        | S35-1A-339 | 339cm  | 46.8 | 8340            | 8820            | 8820            | 8640            |
|                        | S35-1A-367 | 367cm  | 50.7 | 9035            | 9555            | 9555            | 9360            |
|                        | S35-1A-395 | 395cm  | 54.6 | 9730            | 10290           | 10290           | 10080           |
|                        | S35-1A-423 | 423cm  | 58.5 | 10425           | 11025           | 11025           | 10800           |
|                        | S35-1A-451 | 451cm  | 62.4 | 11120           | 11760           | 11760           | 11520           |

wattage: 13.5 W/m

|                        |            |       |      |       |       |       |       |
|------------------------|------------|-------|------|-------|-------|-------|-------|
| CATEGORY 1B 500mA (1B) | S35-1B-59  | 59cm  | 11.6 | 1960  | 2070  | 2070  | 2020  |
|                        | S35-1B-87  | 87cm  | 17.4 | 2940  | 3105  | 3105  | 3030  |
|                        | S35-1B-115 | 115cm | 23.2 | 3920  | 4140  | 4140  | 4040  |
|                        | S35-1B-143 | 143cm | 29   | 4900  | 5175  | 5175  | 5050  |
|                        | S35-1B-171 | 171cm | 34.8 | 5880  | 6210  | 6210  | 6060  |
|                        | S35-1B-199 | 199cm | 40.6 | 6860  | 7245  | 7245  | 7070  |
|                        | S35-1B-227 | 227cm | 46.4 | 7840  | 8280  | 8280  | 8080  |
|                        | S35-1B-255 | 255cm | 52.2 | 8820  | 9315  | 9315  | 9090  |
|                        | S35-1B-283 | 283cm | 58   | 9800  | 10350 | 10350 | 10100 |
|                        | S35-1B-311 | 311cm | 63.8 | 10780 | 11385 | 11385 | 11110 |
|                        | S35-1B-339 | 339cm | 69.6 | 11760 | 12420 | 12420 | 12120 |
|                        | S35-1B-367 | 367cm | 75.4 | 12740 | 13455 | 13455 | 13130 |
|                        | S35-1B-395 | 395cm | 81.2 | 13720 | 14490 | 14490 | 14140 |
|                        | S35-1B-423 | 423cm | 87   | 14700 | 15525 | 15525 | 15150 |
|                        | S35-1B-451 | 451cm | 92.8 | 15680 | 16560 | 16560 | 16160 |

wattage: 20 W/m

Το φωτιστικό είναι διαθέσιμο σε μήκος πολλαπλάσιο των 14 εκατοστών

The illuminant is available in lengths that are multiples of 14 centimeters.

## GILA 35×35 SUSPENDED / Lumen output tables

| CATEGORY 2A 350mA (2A) | code       | length | watt  | lumens<br>3000K | lumens<br>4000K | lumens<br>5000K | lumens<br>6500K |
|------------------------|------------|--------|-------|-----------------|-----------------|-----------------|-----------------|
|                        | S35-2A-59  | 59cm   | 23.6  | 4080            | 4380            | 4380            | 4080            |
|                        | S35-2A-87  | 87cm   | 35.4  | 6120            | 6570            | 6570            | 6120            |
|                        | S35-2A-115 | 115cm  | 47.2  | 8160            | 8760            | 8760            | 8160            |
|                        | S35-2A-143 | 143cm  | 59    | 10200           | 10950           | 10950           | 10200           |
|                        | S35-2A-171 | 171cm  | 70.8  | 12240           | 13140           | 13140           | 12240           |
|                        | S35-2A-199 | 199cm  | 82.6  | 14280           | 15330           | 15330           | 14280           |
|                        | S35-2A-227 | 227cm  | 94.4  | 16320           | 17520           | 17520           | 16320           |
|                        | S35-2A-255 | 255cm  | 106.2 | 18360           | 19710           | 19710           | 18360           |
|                        | S35-2A-283 | 283cm  | 118   | 20400           | 21900           | 21900           | 20400           |
|                        | S35-2A-311 | 311cm  | 129.8 | 22440           | 24090           | 24090           | 22440           |
|                        | S35-2A-339 | 339cm  | 141.6 | 24480           | 26280           | 26280           | 24480           |
|                        | S35-2A-367 | 367cm  | 153.4 | 26520           | 28470           | 28470           | 26520           |
|                        | S35-2A-395 | 395cm  | 165.2 | 28560           | 30660           | 30660           | 28560           |
|                        | S35-2A-423 | 423cm  | 177   | 30600           | 32850           | 32850           | 30600           |
| S35-2A-451             | 451cm      | 188.8  | 32640 | 35040           | 35040           | 32640           |                 |

wattage: 40.5 W/m

|            |       |       |       |       |       |       |
|------------|-------|-------|-------|-------|-------|-------|
| S35-2B-59  | 59cm  | 35    | 5700  | 6140  | 6140  | 5700  |
| S35-2B-87  | 87cm  | 52.5  | 8550  | 9210  | 9210  | 8550  |
| S35-2B-115 | 115cm | 70    | 11400 | 12280 | 12280 | 11400 |
| S35-2B-143 | 143cm | 87.5  | 14250 | 15350 | 15350 | 14250 |
| S35-2B-171 | 171cm | 105   | 17100 | 18420 | 18420 | 17100 |
| S35-2B-199 | 199cm | 122.5 | 19950 | 21490 | 21490 | 19950 |
| S35-2B-227 | 227cm | 140   | 22800 | 24560 | 24560 | 22800 |
| S35-2B-255 | 255cm | 157.5 | 25650 | 27630 | 27630 | 25650 |
| S35-2B-283 | 283cm | 175   | 28500 | 30700 | 30700 | 28500 |
| S35-2B-311 | 311cm | 192.5 | 31350 | 33770 | 33770 | 31350 |
| S35-2B-339 | 339cm | 210   | 34200 | 36840 | 36840 | 34200 |
| S35-2B-367 | 367cm | 227.5 | 37050 | 39910 | 39910 | 37050 |
| S35-2B-395 | 395cm | 245   | 39900 | 42980 | 42980 | 39900 |
| S35-2B-423 | 423cm | 262.5 | 42750 | 46050 | 46050 | 42750 |
| S35-2B-451 | 451cm | 280   | 45600 | 49120 | 49120 | 45600 |

wattage: 60.5 W/m

Το φωτιστικό είναι διαθέσιμο σε μήκος πολλαπλάσιο των 14 εκατοστών

The illuminant is available in lengths that are multiples of 14 centimeters.

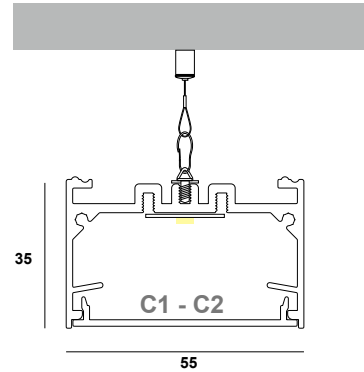

# S5535 - XX - XXX - X - XX - XX - X

|                                  |                       |                 |  |                                     |                  |  |
|----------------------------------|-----------------------|-----------------|--|-------------------------------------|------------------|--|
| (a)                              | (b)                   | (c)             | (d)  | (e)                                 | (f)              | (g)                                    |
| Κωδικός Γραμμικού<br>Linear Code | Κατηγορία<br>Category | Μήκος<br>Length | Θερμοκρασία<br>φωτός<br>Color<br>Temperature | Χρώμα<br>προφίλ<br>Profile<br>color | Κάλυμμα<br>Cover | Αυξομείωση<br>έντασης φωτός<br>Dimming |

### Παράδειγμα κωδικού / Code example

LENA 55×35 SUSPENDED 85cm 1A 3000K Black with Diffuser Dimmable (Hidden power supply)

SKU: S5535-1A-85-3-BL-C1-D-PS3

| material           | pcb details                | CRI                      | lumen output / W |
|--------------------|----------------------------|--------------------------|------------------|
| Extruded aluminium | Zhaga-Compliant Dimensions | Ra>80 (Ra>90 on request) | up to 195 Lm/W   |

| covers                           | profile color | CCT                           | dimming options (D) |
|----------------------------------|---------------|-------------------------------|---------------------|
| Acrylic Diffuser<br>(-C1-)       | Anodised (AN) | 3000K (3)                     | Push                |
|                                  | Black (BL)    | 4000K (4)                     | DALI                |
|                                  | White (WH)    | 5000K (5)                     | TRIAC 0/1-10V       |
| Acrylic Microprismatic<br>(-C2-) | RAL (RL)      | 6500K (6)                     | CASAMBI             |
|                                  |               | TUNABLE<br>2700K - 6500K (TN) | Analog 0/1-10V      |

| power supply installation   |  |  |  |
|---|--|--|--|
| <p>Πάνω στο προφίλ με ροζέτα<br/>On the profile with rosette</p> <p>(-PS1-)</p> | <p>Δίπλα στο προφίλ με ροζέτα<br/>To the side of the profile with rosette</p> <p>(-PS2-)</p> | <p>Σε ροζέτα στην οροφή<br/>In rosette on the ceiling</p> <p>(-PS3-)</p> | <p>Κρυφό με πρόσβαση στο τροφοδοτικό<br/>Hidden with access to the power supply</p> <p>(-PS4-)</p> |



SUSPENDED

## LENA 55×35 SUSPENDED / Lumen output tables

|                        | code         | length | watt | lumens<br>3000K | lumens<br>4000K | lumens<br>5000K | lumens<br>6500K |
|------------------------|--------------|--------|------|-----------------|-----------------|-----------------|-----------------|
| CATEGORY 1A 350mA (1A) | S5535-1A-57  | 57cm   | 7.8  | 1390            | 1470            | 1470            | 1440            |
|                        | S5535-1A-85  | 85cm   | 11.7 | 2085            | 2205            | 2205            | 2160            |
|                        | S5535-1A-113 | 113cm  | 15.6 | 2780            | 2940            | 2940            | 2880            |
|                        | S5535-1A-141 | 141cm  | 19.5 | 3475            | 3675            | 3675            | 3600            |
|                        | S5535-1A-169 | 169cm  | 23.4 | 4170            | 4410            | 4410            | 4320            |
|                        | S5535-1A-197 | 197cm  | 27.3 | 4865            | 5145            | 5145            | 5040            |
|                        | S5535-1A-225 | 225cm  | 31.2 | 5560            | 5880            | 5880            | 5760            |
|                        | S5535-1A-253 | 253cm  | 35.1 | 6255            | 6615            | 6615            | 6480            |
|                        | S5535-1A-281 | 281cm  | 39   | 6950            | 7350            | 7350            | 7200            |
|                        | S5535-1A-309 | 309cm  | 42.9 | 7645            | 8085            | 8085            | 7920            |
|                        | S5535-1A-337 | 337cm  | 46.8 | 8340            | 8820            | 8820            | 8640            |
|                        | S5535-1A-365 | 365cm  | 50.7 | 9035            | 9555            | 9555            | 9360            |
|                        | S5535-1A-393 | 393cm  | 54.6 | 9730            | 10290           | 10290           | 10080           |
|                        | S5535-1A-421 | 421cm  | 58.5 | 10425           | 11025           | 11025           | 10800           |
|                        | S5535-1A-449 | 449cm  | 62.4 | 11120           | 11760           | 11760           | 11520           |

wattage: 13.5 W/m

|                        |              |       |      |       |       |       |       |
|------------------------|--------------|-------|------|-------|-------|-------|-------|
| CATEGORY 1B 500mA (1B) | S5535-1B-57  | 57cm  | 11.6 | 1960  | 2070  | 2070  | 2020  |
|                        | S5535-1B-85  | 85cm  | 17.4 | 2940  | 3105  | 3105  | 3030  |
|                        | S5535-1B-113 | 113cm | 23.2 | 3920  | 4140  | 4140  | 4040  |
|                        | S5535-1B-141 | 141cm | 29   | 4900  | 5175  | 5175  | 5050  |
|                        | S5535-1B-169 | 169cm | 34.8 | 5880  | 6210  | 6210  | 6060  |
|                        | S5535-1B-197 | 197cm | 40.6 | 6860  | 7245  | 7245  | 7070  |
|                        | S5535-1B-225 | 225cm | 46.4 | 7840  | 8280  | 8280  | 8080  |
|                        | S5535-1B-253 | 253cm | 52.2 | 8820  | 9315  | 9315  | 9090  |
|                        | S5535-1B-281 | 281cm | 58   | 9800  | 10350 | 10350 | 10100 |
|                        | S5535-1B-309 | 309cm | 63.8 | 10780 | 11385 | 11385 | 11110 |
|                        | S5535-1B-337 | 337cm | 69.6 | 11760 | 12420 | 12420 | 12120 |
|                        | S5535-1B-365 | 365cm | 75.4 | 12740 | 13455 | 13455 | 13130 |
|                        | S5535-1B-393 | 393cm | 81.2 | 13720 | 14490 | 14490 | 14140 |
|                        | S5535-1B-421 | 421cm | 87   | 14700 | 15525 | 15525 | 15150 |
|                        | S5535-1B-449 | 449cm | 92.8 | 15680 | 16560 | 16560 | 16160 |

wattage: 20 W/m

Το φωτιστικό είναι διαθέσιμο σε μήκος πολλαπλάσιο των 14 εκατοστών

The illuminant is available in lengths that are multiples of 14 centimeters.

## LENA 55×35 SUSPENDED / Lumen output tables

| CATEGORY 2A 350mA (2A) | code         | length | watt  | lumens<br>3000K | lumens<br>4000K | lumens<br>5000K | lumens<br>6500K |
|------------------------|--------------|--------|-------|-----------------|-----------------|-----------------|-----------------|
|                        | S5535-2A-57  | 57cm   | 23.6  | 4080            | 4380            | 4380            | 4080            |
|                        | S5535-2A-85  | 85cm   | 35.4  | 6120            | 6570            | 6570            | 6120            |
|                        | S5535-2A-113 | 113cm  | 47.2  | 8160            | 8760            | 8760            | 8160            |
|                        | S5535-2A-141 | 141cm  | 59    | 10200           | 10950           | 10950           | 10200           |
|                        | S5535-2A-169 | 169cm  | 70.8  | 12240           | 13140           | 13140           | 12240           |
|                        | S5535-2A-197 | 197cm  | 82.6  | 14280           | 15330           | 15330           | 14280           |
|                        | S5535-2A-225 | 225cm  | 94.4  | 16320           | 17520           | 17520           | 16320           |
|                        | S5535-2A-253 | 253cm  | 106.2 | 18360           | 19710           | 19710           | 18360           |
|                        | S5535-2A-281 | 281cm  | 118   | 20400           | 21900           | 21900           | 20400           |
|                        | S5535-2A-309 | 309cm  | 129.8 | 22440           | 24090           | 24090           | 22440           |
|                        | S5535-2A-337 | 337cm  | 141.6 | 24480           | 26280           | 26280           | 24480           |
|                        | S5535-2A-365 | 365cm  | 153.4 | 26520           | 28470           | 28470           | 26520           |
|                        | S5535-2A-393 | 393cm  | 165.2 | 28560           | 30660           | 30660           | 28560           |
|                        | S5535-2A-421 | 421cm  | 177   | 30600           | 32850           | 32850           | 30600           |
| S5535-2A-449           | 449cm        | 188.8  | 32640 | 35040           | 35040           | 32640           |                 |

wattage: 40.5 W/m

|              |       |       |       |       |       |       |
|--------------|-------|-------|-------|-------|-------|-------|
| S5535-2B-57  | 57cm  | 35    | 5700  | 6140  | 6140  | 5700  |
| S5535-2B-85  | 85cm  | 52.5  | 8550  | 9210  | 9210  | 8550  |
| S5535-2B-113 | 113cm | 70    | 11400 | 12280 | 12280 | 11400 |
| S5535-2B-141 | 141cm | 87.5  | 14250 | 15350 | 15350 | 14250 |
| S5535-2B-169 | 169cm | 105   | 17100 | 18420 | 18420 | 17100 |
| S5535-2B-197 | 197cm | 122.5 | 19950 | 21490 | 21490 | 19950 |
| S5535-2B-225 | 225cm | 140   | 22800 | 24560 | 24560 | 22800 |
| S5535-2B-253 | 253cm | 157.5 | 25650 | 27630 | 27630 | 25650 |
| S5535-2B-281 | 281cm | 175   | 28500 | 30700 | 30700 | 28500 |
| S5535-2B-309 | 309cm | 192.5 | 31350 | 33770 | 33770 | 31350 |
| S5535-2B-337 | 337cm | 210   | 34200 | 36840 | 36840 | 34200 |
| S5535-2B-365 | 365cm | 227.5 | 37050 | 39910 | 39910 | 37050 |
| S5535-2B-393 | 393cm | 245   | 39900 | 42980 | 42980 | 39900 |
| S5535-2B-421 | 421cm | 262.5 | 42750 | 46050 | 46050 | 42750 |
| S5535-2B-449 | 449cm | 280   | 45600 | 49120 | 49120 | 45600 |

wattage: 60.5 W/m

Το φωτιστικό είναι διαθέσιμο σε μήκος πολλαπλάσιο των 14 εκατοστών

The illuminant is available in lengths that are multiples of 14 centimeters.

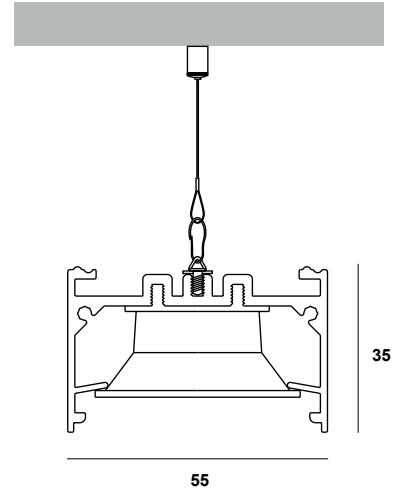

# SD5535 - XX - XXX - X - XXX - XX - X - X - XXX

| (a)                              | (b)                   | (c)             | (d)  | (e)                        | (f)                                 | (g)                                       | (h)                                       | (i)  |
|----------------------------------|-----------------------|-----------------|--|----------------------------|-------------------------------------|---|---|--|
| Κωδικός Γραμμικού<br>Linear Code | Κατηγορία<br>Category | Μήκος<br>Length | Θερμοκρασία<br>φωτός<br>Color<br>Temperature | Γωνία Δέσμης<br>Beam Angle | Χρώμα<br>προφίλ<br>Profile<br>Color | Χρώμα<br>Ρεφλέκτορα<br>Reflector<br>Color | Αυξομείωση<br>έντασης<br>φωτός<br>Dimming | Τοποθέτηση<br>τροφοδοτικού<br>Power supply<br>installation |

## Παράδειγμα κωδικού / Code example

DARK LENA 55×35 SUSPENDED 1A 84.5cm 3000K 65° Black with Black Reflector Dimmable (Hidden power supply)

SKU: SD5535-1A-85-3-60D-BL-1-D-PS3

| material                     | pcb details          | CRI                      | lumen output / W |
|------------------------------|----------------------|--------------------------|------------------|
| Extruded aluminium / Plastic | SMD light & dark 7×1 | Ra>90 (Ra>80 on request) | up to 205 Lm/W   |

| CCT                           | beam angle       | profile color | reflector color | dimming options (D) |
|-------------------------------|------------------|---------------|-----------------|---------------------|
| 3000K (3)                     | Medium 65° (60D) | Anodised (AN) | Black (1)       | Push                |
| 4000K (4)                     | Wide 90° (90D)   | Black (BL)    | White (2)       | DALI                |
| TUNABLE<br>2700K - 6500K (TN) |                  | White (WH)    |                 | TRIAC 0/1-10V       |
|                               |                  | RAL (RL)      |                 | CASAMBI             |
|                               |                  |               |                 | Analog 0/1-10V      |

| power supply installation   |  |  |  |
|---|--|--|--|
| <p>Πάνω στο προφίλ με ροζέτα<br/>On the profile with rosette</p> <p>(-PS1-)</p> | <p>Δίπλα στο προφίλ με ροζέτα<br/>To the side of the profile with rosette</p> <p>(-PS2-)</p> | <p>Σε ροζέτα στην οροφή<br/>In rosette on the ceiling</p> <p>(-PS3-)</p> | <p>Κρυφό με πρόσβαση στο τροφοδοτικό<br/>Hidden with access to the power supply</p> <p>(-PS4-)</p> |

## DARK LENA 55×35 SUSPENDED / Lumen output tables

| CATEGORY 1A 350mA (1A) | code            | length  | watt  | lumens<br>3000K (65°) | lumens<br>3000K (90°) | lumens<br>4000K (65°) | lumens<br>4000K (90°) |
|------------------------|-----------------|---------|-------|-----------------------|-----------------------|-----------------------|-----------------------|
|                        | SD5535-1A-56.5  | 56.5cm  | 13.4  | 1702                  | 1680                  | 1774                  | 1752                  |
|                        | SD5535-1A-84.5  | 84.5cm  | 20.1  | 2553                  | 2520                  | 2661                  | 2628                  |
|                        | SD5535-1A-112.5 | 112.5cm | 26.8  | 3404                  | 3360                  | 3548                  | 3504                  |
|                        | SD5535-1A-140.5 | 140.5cm | 33.5  | 4255                  | 4200                  | 4435                  | 4380                  |
|                        | SD5535-1A-168.5 | 168.5cm | 40.2  | 5106                  | 5040                  | 5322                  | 5256                  |
|                        | SD5535-1A-196.5 | 196.5cm | 46.9  | 5957                  | 5880                  | 6209                  | 6132                  |
|                        | SD5535-1A-224.5 | 224.5cm | 53.6  | 6808                  | 6720                  | 7096                  | 7008                  |
|                        | SD5535-1A-252.5 | 252.5cm | 60.3  | 7659                  | 7560                  | 7983                  | 7884                  |
|                        | SD5535-1A-280.5 | 280.5cm | 67    | 8510                  | 8400                  | 8870                  | 8760                  |
|                        | SD5535-1A-308.5 | 308.5cm | 73.7  | 9361                  | 9240                  | 9757                  | 9636                  |
|                        | SD5535-1A-36.5  | 336.5cm | 80.4  | 10212                 | 10080                 | 10644                 | 10512                 |
|                        | SD5535-1A-364.5 | 364.5cm | 87.1  | 11063                 | 10920                 | 11531                 | 11388                 |
|                        | SD5535-1A-392.5 | 392.5cm | 93.8  | 11914                 | 11760                 | 12418                 | 12264                 |
|                        | SD5535-1A-420.5 | 420.5cm | 100.5 | 12765                 | 12600                 | 13305                 | 13140                 |
|                        | SD5535-1A-448.5 | 448.5cm | 107.2 | 13616                 | 13440                 | 14192                 | 14016                 |

wattage: 23 W/m

|                 |         |       |       |       |       |       |
|-----------------|---------|-------|-------|-------|-------|-------|
| SD5535-1B-56.5  | 56.5cm  | 19.8  | 2398  | 2368  | 2512  | 2480  |
| SD5535-1B-84.5  | 84.5cm  | 29.7  | 3597  | 3552  | 3768  | 3720  |
| SD5535-1B-112.5 | 112.5cm | 39.6  | 4796  | 4736  | 5024  | 4960  |
| SD5535-1B-140.5 | 140.5cm | 49.5  | 5995  | 5920  | 6280  | 6200  |
| SD5535-1B-168.5 | 168.5cm | 59.4  | 7194  | 7104  | 7536  | 7440  |
| SD5535-1B-196.5 | 196.5cm | 69.3  | 8393  | 8288  | 8792  | 8680  |
| SD5535-1B-224.5 | 224.5cm | 79.2  | 9592  | 9472  | 10048 | 9920  |
| SD5535-1B-252.5 | 252.5cm | 89.1  | 10791 | 10656 | 11304 | 11160 |
| SD5535-1B-280.5 | 280.5cm | 99    | 11990 | 11840 | 12560 | 12400 |
| SD5535-1B-308.5 | 308.5cm | 108.9 | 13189 | 13024 | 13816 | 13640 |
| SD5535-1B-36.5  | 336.5cm | 118.8 | 14388 | 14208 | 15072 | 14880 |
| SD5535-1B-364.5 | 364.5cm | 128.7 | 15587 | 15392 | 16328 | 16120 |
| SD5535-1B-392.5 | 392.5cm | 138.6 | 16786 | 16576 | 17584 | 17360 |
| SD5535-1B-420.5 | 420.5cm | 148.5 | 17985 | 17760 | 18840 | 18600 |
| SD5535-1B-448.5 | 448.5cm | 158.4 | 19184 | 18944 | 20096 | 19840 |

wattage: 34 W/m

Το φωτιστικό είναι διαθέσιμο σε μήκος πολλαπλάσιο των 28 εκατοστών

The illuminant is available in lengths that are multiples of 28 centimeters.



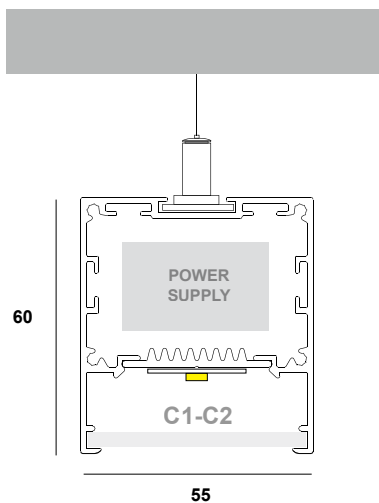

S5560 - XX - XXX - X - XX - XX - X

- (a)  
Κωδικός Γραμμικού  
Linear Code
- (b)  
Κατηγορία  
Category
- (c)  
Μήκος  
Length
- (d)  
Θερμοκρασία  
φωτός  
Color  
Temperature
- (e)  
Χρώμα  
Color
- (f)  
Κάλυμμα  
Cover
- (g)  
Αυξομείωση  
έντασης φωτός  
Dimming

**Παράδειγμα κωδικού / Code example**

GANGES 55×60 SUSPENDED 85cm 1A 3000K Black with Diffuser Dimmable  
 SKU: S5560-1A-85-3-BL-C1-D

| material           | pcb details                | CRI                      | lumen output / W |
|--------------------|----------------------------|--------------------------|------------------|
| Extruded aluminium | Zhaga-Compliant Dimensions | Ra>80 (Ra>90 on request) | up to 195 Lm/W   |

| covers                    | profile color | CCT                        | dimming options (D) |
|---------------------------|---------------|----------------------------|---------------------|
| Diffuser 3mm (-C1-)       | Anodised (AN) | 3000K (3)                  | Push                |
|                           | Black (BL)    | 4000K (4)                  | DALI                |
|                           | White (WH)    | 5000K (5)                  | TRIAC 0/1-10V       |
| Microprismatic 3mm (-C2-) | RAL (RL)      | 6500K (6)                  | CASAMBI             |
|                           |               | TUNABLE 2700K - 6500K (TN) | Analog 0/1-10V      |

## GANGES 55×60 SUSPENDED / Lumen output tables

| CATEGORY 1A 350mA (1A) | code         | length | watt  | lumens<br>3000K | lumens<br>4000K | lumens<br>5000K | lumens<br>6500K |
|------------------------|--------------|--------|-------|-----------------|-----------------|-----------------|-----------------|
|                        | S5560-1A-57  | 57cm   | 7.8   | 1390            | 1470            | 1470            | 1440            |
|                        | S5560-1A-85  | 85cm   | 11.7  | 2085            | 2205            | 2205            | 2160            |
|                        | S5560-1A-113 | 113cm  | 15.6  | 2780            | 2940            | 2940            | 2880            |
|                        | S5560-1A-141 | 141cm  | 19.5  | 3475            | 3675            | 3675            | 3600            |
|                        | S5560-1A-169 | 169cm  | 23.4  | 4170            | 4410            | 4410            | 4320            |
|                        | S5560-1A-197 | 197cm  | 27.3  | 4865            | 5145            | 5145            | 5040            |
|                        | S5560-1A-225 | 225cm  | 31.2  | 5560            | 5880            | 5880            | 5760            |
|                        | S5560-1A-253 | 253cm  | 35.1  | 6255            | 6615            | 6615            | 6480            |
|                        | S5560-1A-281 | 281cm  | 39    | 6950            | 7350            | 7350            | 7200            |
|                        | S5560-1A-309 | 309cm  | 42.9  | 7645            | 8085            | 8085            | 7920            |
|                        | S5560-1A-337 | 337cm  | 46.8  | 8340            | 8820            | 8820            | 8640            |
|                        | S5560-1A-365 | 365cm  | 50.7  | 9035            | 9555            | 9555            | 9360            |
|                        | S5560-1A-393 | 393cm  | 54.6  | 9730            | 10290           | 10290           | 10080           |
|                        | S5560-1A-421 | 421cm  | 58.5  | 10425           | 11025           | 11025           | 10800           |
| S5560-1A-449           | 449cm        | 62.4   | 11120 | 11760           | 11760           | 11520           |                 |

wattage: 13.5 W/m

|              |       |      |       |       |       |       |
|--------------|-------|------|-------|-------|-------|-------|
| S5560-1B-57  | 57cm  | 11.6 | 1960  | 2070  | 2070  | 2020  |
| S5560-1B-85  | 85cm  | 17.4 | 2940  | 3105  | 3105  | 3030  |
| S5560-1B-113 | 113cm | 23.2 | 3920  | 4140  | 4140  | 4040  |
| S5560-1B-141 | 141cm | 29   | 4900  | 5175  | 5175  | 5050  |
| S5560-1B-169 | 169cm | 34.8 | 5880  | 6210  | 6210  | 6060  |
| S5560-1B-197 | 197cm | 40.6 | 6860  | 7245  | 7245  | 7070  |
| S5560-1B-225 | 225cm | 46.4 | 7840  | 8280  | 8280  | 8080  |
| S5560-1B-253 | 253cm | 52.2 | 8820  | 9315  | 9315  | 9090  |
| S5560-1B-281 | 281cm | 58   | 9800  | 10350 | 10350 | 10100 |
| S5560-1B-309 | 309cm | 63.8 | 10780 | 11385 | 11385 | 11110 |
| S5560-1B-337 | 337cm | 69.6 | 11760 | 12420 | 12420 | 12120 |
| S5560-1B-365 | 365cm | 75.4 | 12740 | 13455 | 13455 | 13130 |
| S5560-1B-393 | 393cm | 81.2 | 13720 | 14490 | 14490 | 14140 |
| S5560-1B-421 | 421cm | 87   | 14700 | 15525 | 15525 | 15150 |
| S5560-1B-449 | 449cm | 92.8 | 15680 | 16560 | 16560 | 16160 |

wattage: 20 W/m

Το φωτιστικό είναι διαθέσιμο σε μήκος πολλαπλάσιο των 14 εκατοστών

The illuminant is available in lengths that are multiples of 14 centimeters.

## GANGES 55×60 SUSPENDED / Lumen output tables

|                        | code         | length | watt  | lumens<br>3000K | lumens<br>4000K | lumens<br>5000K | lumens<br>6500K |
|------------------------|--------------|--------|-------|-----------------|-----------------|-----------------|-----------------|
| CATEGORY 2A 350mA (2A) | S5560-2A-57  | 57cm   | 23.6  | 4080            | 4380            | 4380            | 4080            |
|                        | S5560-2A-85  | 85cm   | 35.4  | 6120            | 6570            | 6570            | 6120            |
|                        | S5560-2A-113 | 113cm  | 47.2  | 8160            | 8760            | 8760            | 8160            |
|                        | S5560-2A-141 | 141cm  | 59    | 10200           | 10950           | 10950           | 10200           |
|                        | S5560-2A-169 | 169cm  | 70.8  | 12240           | 13140           | 13140           | 12240           |
|                        | S5560-2A-197 | 197cm  | 82.6  | 14280           | 15330           | 15330           | 14280           |
|                        | S5560-2A-225 | 225cm  | 94.4  | 16320           | 17520           | 17520           | 16320           |
|                        | S5560-2A-253 | 253cm  | 106.2 | 18360           | 19710           | 19710           | 18360           |
|                        | S5560-2A-281 | 281cm  | 118   | 20400           | 21900           | 21900           | 20400           |
|                        | S5560-2A-309 | 309cm  | 129.8 | 22440           | 24090           | 24090           | 22440           |
|                        | S5560-2A-337 | 337cm  | 141.6 | 24480           | 26280           | 26280           | 24480           |
|                        | S5560-2A-365 | 365cm  | 153.4 | 26520           | 28470           | 28470           | 26520           |
|                        | S5560-2A-393 | 393cm  | 165.2 | 28560           | 30660           | 30660           | 28560           |
|                        | S5560-2A-421 | 421cm  | 177   | 30600           | 32850           | 32850           | 30600           |
|                        | S5560-2A-449 | 449cm  | 188.8 | 32640           | 35040           | 35040           | 32640           |

wattage: 40.5 W/m

|                        |              |       |       |       |       |       |       |
|------------------------|--------------|-------|-------|-------|-------|-------|-------|
| CATEGORY 2B 500mA (2B) | S5560-2B-57  | 57cm  | 35    | 5700  | 6140  | 6140  | 5700  |
|                        | S5560-2B-85  | 85cm  | 52.5  | 8550  | 9210  | 9210  | 8550  |
|                        | S5560-2B-113 | 113cm | 70    | 11400 | 12280 | 12280 | 11400 |
|                        | S5560-2B-141 | 141cm | 87.5  | 14250 | 15350 | 15350 | 14250 |
|                        | S5560-2B-169 | 169cm | 105   | 17100 | 18420 | 18420 | 17100 |
|                        | S5560-2B-197 | 197cm | 122.5 | 19950 | 21490 | 21490 | 19950 |
|                        | S5560-2B-225 | 225cm | 140   | 22800 | 24560 | 24560 | 22800 |
|                        | S5560-2B-253 | 253cm | 157.5 | 25650 | 27630 | 27630 | 25650 |
|                        | S5560-2B-281 | 281cm | 175   | 28500 | 30700 | 30700 | 28500 |
|                        | S5560-2B-309 | 309cm | 192.5 | 31350 | 33770 | 33770 | 31350 |
|                        | S5560-2B-337 | 337cm | 210   | 34200 | 36840 | 36840 | 34200 |
|                        | S5560-2B-365 | 365cm | 227.5 | 37050 | 39910 | 39910 | 37050 |
|                        | S5560-2B-393 | 393cm | 245   | 39900 | 42980 | 42980 | 39900 |
|                        | S5560-2B-421 | 421cm | 262.5 | 42750 | 46050 | 46050 | 42750 |
|                        | S5560-2B-449 | 449cm | 280   | 45600 | 49120 | 49120 | 45600 |

wattage: 60.5 W/m

Το φωτιστικό είναι διαθέσιμο σε μήκος πολλαπλάσιο των 14 εκατοστών

The illuminant is available in lengths that are multiples of 14 centimeters.



SUSPENDED

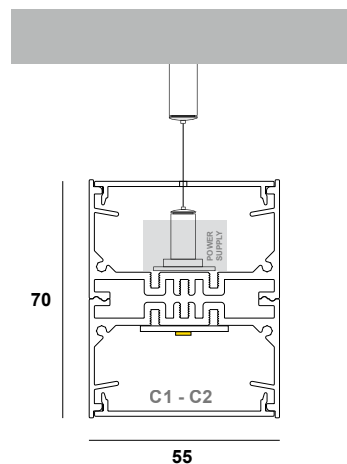

S5570 - XX - XXX - X - XX - XX - X

- (a)  
Κωδικός Γραμμικού  
Linear Code
- (b)  
Κατηγορία  
Category
- (c)  
Μήκος  
Length
- (d)  
Θερμοκρασία  
φωτός  
Color  
Temperature
- (e)  
Χρώμα  
προφίλ  
Profile  
color
- (f)  
Κάλυμμα  
Cover
- (g)  
Αυξομείωση  
έντασης φωτός  
Dimming

**Παράδειγμα κωδικού / Code example**

LINEAR 55×70 SUSPENDED 85cm 1A 3000K Black with Diffuser Dimmable

SKU: S5570-1A-85-3-BL-C1-D

| material           | pcb details                | CRI                      | lumen output / W |
|--------------------|----------------------------|--------------------------|------------------|
| Extruded aluminium | Zhaga-Compliant Dimensions | Ra>80 (Ra>90 on request) | up to 195 Lm/W   |

| covers                        | profile color | CCT                           | dimming options (D) |
|-------------------------------|---------------|-------------------------------|---------------------|
| Acrylic Diffuser (-C1-)       | Anodised (AN) | 3000K (3)                     | Push                |
|                               | Black (BL)    | 4000K (4)                     | DALI                |
|                               | White (WH)    | 5000K (5)                     | TRIAC 0/1-10V       |
| Acrylic Microprismatic (-C2-) | RAL (RL)      | 6500K (6)                     | CASAMBI             |
|                               |               | TUNABLE<br>2700K - 6500K (TN) | Analog 0/1-10V      |

## LINEAR 55×70 SUSPENDED / Lumen output tables

| CATEGORY 1A 350mA (1A) | code         | length | watt  | lumens<br>3000K | lumens<br>4000K | lumens<br>5000K | lumens<br>6500K |
|------------------------|--------------|--------|-------|-----------------|-----------------|-----------------|-----------------|
|                        | S5570-1A-57  | 57cm   | 7.8   | 1390            | 1470            | 1470            | 1440            |
|                        | S5570-1A-85  | 85cm   | 11.7  | 2085            | 2205            | 2205            | 2160            |
|                        | S5570-1A-113 | 113cm  | 15.6  | 2780            | 2940            | 2940            | 2880            |
|                        | S5570-1A-141 | 141cm  | 19.5  | 3475            | 3675            | 3675            | 3600            |
|                        | S5570-1A-169 | 169cm  | 23.4  | 4170            | 4410            | 4410            | 4320            |
|                        | S5570-1A-197 | 197cm  | 27.3  | 4865            | 5145            | 5145            | 5040            |
|                        | S5570-1A-225 | 225cm  | 31.2  | 5560            | 5880            | 5880            | 5760            |
|                        | S5570-1A-253 | 253cm  | 35.1  | 6255            | 6615            | 6615            | 6480            |
|                        | S5570-1A-281 | 281cm  | 39    | 6950            | 7350            | 7350            | 7200            |
|                        | S5570-1A-309 | 309cm  | 42.9  | 7645            | 8085            | 8085            | 7920            |
|                        | S5570-1A-337 | 337cm  | 46.8  | 8340            | 8820            | 8820            | 8640            |
|                        | S5570-1A-365 | 365cm  | 50.7  | 9035            | 9555            | 9555            | 9360            |
|                        | S5570-1A-393 | 393cm  | 54.6  | 9730            | 10290           | 10290           | 10080           |
|                        | S5570-1A-421 | 421cm  | 58.5  | 10425           | 11025           | 11025           | 10800           |
| S5570-1A-449           | 449cm        | 62.4   | 11120 | 11760           | 11760           | 11520           |                 |

wattage: 13.5 W/m

|              |       |      |       |       |       |       |
|--------------|-------|------|-------|-------|-------|-------|
| S5570-1B-57  | 57cm  | 11.6 | 1960  | 2070  | 2070  | 2020  |
| S5570-1B-85  | 85cm  | 17.4 | 2940  | 3105  | 3105  | 3030  |
| S5570-1B-113 | 113cm | 23.2 | 3920  | 4140  | 4140  | 4040  |
| S5570-1B-141 | 141cm | 29   | 4900  | 5175  | 5175  | 5050  |
| S5570-1B-169 | 169cm | 34.8 | 5880  | 6210  | 6210  | 6060  |
| S5570-1B-197 | 197cm | 40.6 | 6860  | 7245  | 7245  | 7070  |
| S5570-1B-225 | 225cm | 46.4 | 7840  | 8280  | 8280  | 8080  |
| S5570-1B-253 | 253cm | 52.2 | 8820  | 9315  | 9315  | 9090  |
| S5570-1B-281 | 281cm | 58   | 9800  | 10350 | 10350 | 10100 |
| S5570-1B-309 | 309cm | 63.8 | 10780 | 11385 | 11385 | 11110 |
| S5570-1B-337 | 337cm | 69.6 | 11760 | 12420 | 12420 | 12120 |
| S5570-1B-365 | 365cm | 75.4 | 12740 | 13455 | 13455 | 13130 |
| S5570-1B-393 | 393cm | 81.2 | 13720 | 14490 | 14490 | 14140 |
| S5570-1B-421 | 421cm | 87   | 14700 | 15525 | 15525 | 15150 |
| S5570-1B-449 | 449cm | 92.8 | 15680 | 16560 | 16560 | 16160 |

wattage: 20 W/m

Το φωτιστικό είναι διαθέσιμο σε μήκος πολλαπλάσιο των 14 εκατοστών  
 The illuminant is available in lengths that are multiples of 14 centimeters.



## LINEAR 55×70 SUSPENDED / Lumen output tables

| CATEGORY 2A 350mA (2A) | code         | length | watt  | lumens 3000K | lumens 4000K | lumens 5000K | lumens 6500K |
|------------------------|--------------|--------|-------|--------------|--------------|--------------|--------------|
|                        | S5570-2A-57  | 57cm   | 23.6  | 4080         | 4380         | 4380         | 4080         |
|                        | S5570-2A-85  | 85cm   | 35.4  | 6120         | 6570         | 6570         | 6120         |
|                        | S5570-2A-113 | 113cm  | 47.2  | 8160         | 8760         | 8760         | 8160         |
|                        | S5570-2A-141 | 141cm  | 59    | 10200        | 10950        | 10950        | 10200        |
|                        | S5570-2A-169 | 169cm  | 70.8  | 12240        | 13140        | 13140        | 12240        |
|                        | S5570-2A-197 | 197cm  | 82.6  | 14280        | 15330        | 15330        | 14280        |
|                        | S5570-2A-225 | 225cm  | 94.4  | 16320        | 17520        | 17520        | 16320        |
|                        | S5570-2A-253 | 253cm  | 106.2 | 18360        | 19710        | 19710        | 18360        |
|                        | S5570-2A-281 | 281cm  | 118   | 20400        | 21900        | 21900        | 20400        |
|                        | S5570-2A-309 | 309cm  | 129.8 | 22440        | 24090        | 24090        | 22440        |
|                        | S5570-2A-337 | 337cm  | 141.6 | 24480        | 26280        | 26280        | 24480        |
|                        | S5570-2A-365 | 365cm  | 153.4 | 26520        | 28470        | 28470        | 26520        |
|                        | S5570-2A-393 | 393cm  | 165.2 | 28560        | 30660        | 30660        | 28560        |
|                        | S5570-2A-421 | 421cm  | 177   | 30600        | 32850        | 32850        | 30600        |
| S5570-2A-449           | 449cm        | 188.8  | 32640 | 35040        | 35040        | 32640        |              |

wattage: 40.5 W/m

| CATEGORY 2B 500mA (2B) | code         | length | watt  | lumens 3000K | lumens 4000K | lumens 5000K | lumens 6500K |
|------------------------|--------------|--------|-------|--------------|--------------|--------------|--------------|
|                        | S5570-2B-57  | 57cm   | 35    | 5700         | 6140         | 6140         | 5700         |
|                        | S5570-2B-85  | 85cm   | 52.5  | 8550         | 9210         | 9210         | 8550         |
|                        | S5570-2B-113 | 113cm  | 70    | 11400        | 12280        | 12280        | 11400        |
|                        | S5570-2B-141 | 141cm  | 87.5  | 14250        | 15350        | 15350        | 14250        |
|                        | S5570-2B-169 | 169cm  | 105   | 17100        | 18420        | 18420        | 17100        |
|                        | S5570-2B-197 | 197cm  | 122.5 | 19950        | 21490        | 21490        | 19950        |
|                        | S5570-2B-225 | 225cm  | 140   | 22800        | 24560        | 24560        | 22800        |
|                        | S5570-2B-253 | 253cm  | 157.5 | 25650        | 27630        | 27630        | 25650        |
|                        | S5570-2B-281 | 281cm  | 175   | 28500        | 30700        | 30700        | 28500        |
|                        | S5570-2B-309 | 309cm  | 192.5 | 31350        | 33770        | 33770        | 31350        |
|                        | S5570-2B-337 | 337cm  | 210   | 34200        | 36840        | 36840        | 34200        |
|                        | S5570-2B-365 | 365cm  | 227.5 | 37050        | 39910        | 39910        | 37050        |
|                        | S5570-2B-393 | 393cm  | 245   | 39900        | 42980        | 42980        | 39900        |
|                        | S5570-2B-421 | 421cm  | 262.5 | 42750        | 46050        | 46050        | 42750        |
| S5570-2B-449           | 449cm        | 280    | 45600 | 49120        | 49120        | 45600        |              |

wattage: 60.5 W/m

Το φωτιστικό είναι διαθέσιμο σε μήκος πολλαπλάσιο των 14 εκατοστών

The illuminant is available in lengths that are multiples of 14 centimeters.

DARK LINEAR 55×70 SUSPENDED (SD5570-)

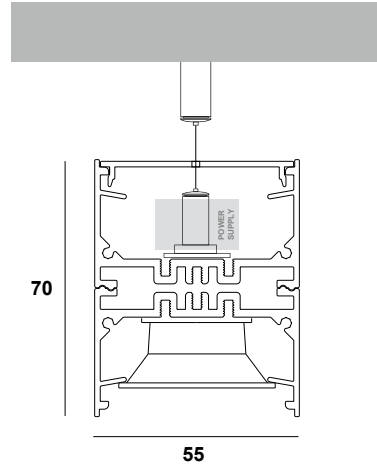
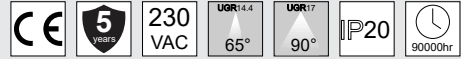

SD5570 - XX - XXX - X - XXX - XX - X - X

|                                  |                       |                 |  |                            |                                     |   |   |
|----------------------------------|-----------------------|-----------------|--|----------------------------|-------------------------------------|---|---|
| (a)                              | (b)                   | (c)             | (d)  | (e)                        | (f)                                 | (g)                                       | (h)                                       |
| Κωδικός Γραμμικού<br>Linear Code | Κατηγορία<br>Category | Μήκος<br>Length | Θερμοκρασία<br>φωτός<br>Color<br>Temperature | Γωνία Δέσμης<br>Beam Angle | Χρώμα<br>προφίλ<br>Profile<br>Color | Χρώμα<br>Ρεφλέκτορα<br>Reflector<br>Color | Αυξομείωση<br>έντασης<br>φωτός<br>Dimming |

Παράδειγμα κωδικού / Code example

DARK LINEAR 55×70 SUSPENDED 1A 84.5cm 3000K 65° Black with Black Reflector Dimmable

SKU: SD5570-1A-85-3-60D-BL-1-D

| material                     | pcb details          | CRI                      | lumen output / W |
|------------------------------|----------------------|--------------------------|------------------|
| Extruded aluminium / Plastic | SMD light & dark 7×1 | Ra>90 (Ra>80 on request) | up to 205 Lm/W   |

| CCT                           | beam angle       | profile color | reflector color | dimming options (D) |
|-------------------------------|------------------|---------------|-----------------|---------------------|
| 3000K (3)                     | Medium 65° (60D) | Anodised (AN) | Black (1)       | Push                |
| 4000K (4)                     | Wide 90° (90D)   | Black (BL)    | White (2)       | DALI                |
| TUNABLE<br>2700K - 6500K (TN) |                  | White (WH)    |                 | TRIAC 0/1-10V       |
|                               |                  | RAL (RL)      |                 | CASAMBI             |
|                               |                  |               |                 | Analog 0/1-10V      |



## DARK LINEAR 55×70 SUSPENDED / Lumen output tables

| CATEGORY 1A 350mA (1A) | code          | length | watt  | lumens<br>3000K (65°) | lumens<br>3000K (90°) | lumens<br>4000K (65°) | lumens<br>4000K (90°) |
|------------------------|---------------|--------|-------|-----------------------|-----------------------|-----------------------|-----------------------|
|                        | SD5570-1A-57  | 57cm   | 13.4  | 1702                  | 1680                  | 1774                  | 1752                  |
|                        | SD5570-1A-85  | 85cm   | 20.1  | 2553                  | 2520                  | 2661                  | 2628                  |
|                        | SD5570-1A-113 | 113cm  | 26.8  | 3404                  | 3360                  | 3548                  | 3504                  |
|                        | SD5570-1A-141 | 141cm  | 33.5  | 4255                  | 4200                  | 4435                  | 4380                  |
|                        | SD5570-1A-169 | 169cm  | 40.2  | 5106                  | 5040                  | 5322                  | 5256                  |
|                        | SD5570-1A-197 | 197cm  | 46.9  | 5957                  | 5880                  | 6209                  | 6132                  |
|                        | SD5570-1A-225 | 225cm  | 53.6  | 6808                  | 6720                  | 7096                  | 7008                  |
|                        | SD5570-1A-253 | 253cm  | 60.3  | 7659                  | 7560                  | 7983                  | 7884                  |
|                        | SD5570-1A-281 | 281cm  | 67    | 8510                  | 8400                  | 8870                  | 8760                  |
|                        | SD5570-1A-309 | 309cm  | 73.7  | 9361                  | 9240                  | 9757                  | 9636                  |
|                        | SD5570-1A-337 | 337m   | 80.4  | 10212                 | 10080                 | 10644                 | 10512                 |
|                        | SD5570-1A-365 | 365m   | 87.1  | 11063                 | 10920                 | 11531                 | 11388                 |
|                        | SD5570-1A-393 | 393cm  | 93.8  | 11914                 | 11760                 | 12418                 | 12264                 |
|                        | SD5570-1A-421 | 421cm  | 100.5 | 12765                 | 12600                 | 13305                 | 13140                 |
|                        | SD5570-1A-449 | 449cm  | 107.2 | 13616                 | 13440                 | 14192                 | 14016                 |

wattage: 23 W/m

| CATEGORY 1B 500mA (1B) | code          | length | watt  | lumens<br>3000K (65°) | lumens<br>3000K (90°) | lumens<br>4000K (65°) | lumens<br>4000K (90°) |
|------------------------|---------------|--------|-------|-----------------------|-----------------------|-----------------------|-----------------------|
|                        | SD5570-1B-57  | 57cm   | 19.8  | 2398                  | 2368                  | 2512                  | 2480                  |
|                        | SD5570-1B-85  | 85cm   | 29.7  | 3597                  | 3552                  | 3768                  | 3720                  |
|                        | SD5570-1B-113 | 113cm  | 39.6  | 4796                  | 4736                  | 5024                  | 4960                  |
|                        | SD5570-1B-141 | 141cm  | 49.5  | 5995                  | 5920                  | 6280                  | 6200                  |
|                        | SD5570-1B-169 | 169cm  | 59.4  | 7194                  | 7104                  | 7536                  | 7440                  |
|                        | SD5570-1B-197 | 197cm  | 69.3  | 8393                  | 8288                  | 8792                  | 8680                  |
|                        | SD5570-1B-225 | 225cm  | 79.2  | 9592                  | 9472                  | 10048                 | 9920                  |
|                        | SD5570-1B-253 | 253cm  | 89.1  | 10791                 | 10656                 | 11304                 | 11160                 |
|                        | SD5570-1B-281 | 281cm  | 99    | 11990                 | 11840                 | 12560                 | 12400                 |
|                        | SD5570-1B-309 | 309cm  | 108.9 | 13189                 | 13024                 | 13816                 | 13640                 |
|                        | SD5570-1B-337 | 337m   | 118.8 | 14388                 | 14208                 | 15072                 | 14880                 |
|                        | SD5570-1B-365 | 365m   | 128.7 | 15587                 | 15392                 | 16328                 | 16120                 |
|                        | SD5570-1B-393 | 393cm  | 138.6 | 16786                 | 16576                 | 17584                 | 17360                 |
|                        | SD5570-1B-421 | 421cm  | 148.5 | 17985                 | 17760                 | 18840                 | 18600                 |
|                        | SD5570-1B-449 | 449cm  | 158.4 | 19184                 | 18944                 | 20096                 | 19840                 |

wattage: 34 W/m

Το φωτιστικό είναι διαθέσιμο σε μήκος πολλαπλάσιο των 28 εκατοστών

The illuminant is available in lengths that are multiples of 28 centimeters.



SUSPENDED

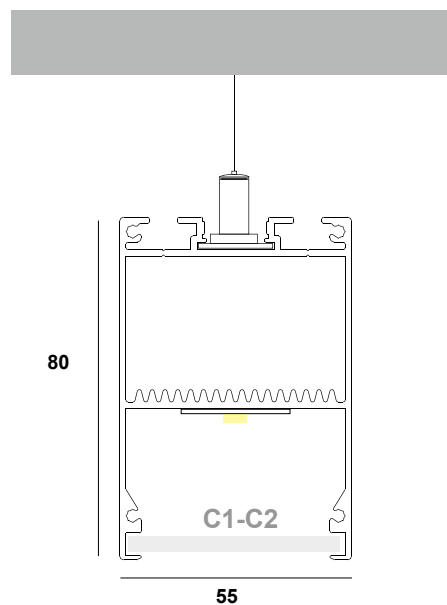



S5580 - XX - XXX - X - XX - XX - X

- (a)**  
Κωδικός Γραμμικού  
Linear Code
- (b)**  
Κατηγορία  
Category
- (c)**  
Μήκος  
Length
- (d)**  
Θερμοκρασία  
φωτός  
Color  
Temperature
- (e)**  
Χρώμα  
προφίλ  
Profile  
color
- (f)**  
Κάλυμμα  
Cover
- (g)**  
Αυξομείωση  
έντασης φωτός  
Dimming

**Παράδειγμα κωδικού / Code example**

NILE 55×80 SUSPENDED 87cm 1A 3000K Black with Diffuser Dimmable  
**SKU:** S5580-1A-87-3-BL-C1-D

| material           | pcb details                | CRI                                 | lumen output / W |
|--------------------|----------------------------|-------------------------------------|------------------|
| Extruded aluminium | Zhaga-Compliant Dimensions | Ra>80 ( <b>Ra&gt;90</b> on request) | up to 195 Lm/W   |

| covers  | profile color          | CCT                                    | dimming options (D) |
|---|------------------------|--|---------------------|
| Diffuser 3mm (-C1-)        | Anodised ( <b>AN</b> ) | 3000K ( <b>3</b> )                     | Push                |
|   | Black ( <b>BL</b> )    | 4000K ( <b>4</b> )                     | DALI                |
|   | White ( <b>WH</b> )    | 5000K ( <b>5</b> )                     | TRIAC 0/1-10V       |
| Microprismatic 3mm (-C2-)  | RAL ( <b>RL</b> )      | 6500K ( <b>6</b> )                     | CASAMBI             |
|   |                        | TUNABLE<br>2700K - 6500K ( <b>TN</b> ) | Analog 0/1-10V      |

## NILE 55×80 SUSPENDED / Lumen output tables

| CATEGORY 1A 350mA (1A) | code         | length | watt  | lumens 3000K | lumens 4000K | lumens 5000K | lumens 6500K |
|------------------------|--------------|--------|-------|--------------|--------------|--------------|--------------|
|                        | S5580-1A-59  | 59cm   | 7.8   | 1390         | 1470         | 1470         | 1440         |
|                        | S5580-1A-87  | 87cm   | 11.7  | 2085         | 2205         | 2205         | 2160         |
|                        | S5580-1A-115 | 115cm  | 15.6  | 2780         | 2940         | 2940         | 2880         |
|                        | S5580-1A-143 | 143cm  | 19.5  | 3475         | 3675         | 3675         | 3600         |
|                        | S5580-1A-171 | 171cm  | 23.4  | 4170         | 4410         | 4410         | 4320         |
|                        | S5580-1A-199 | 199cm  | 27.3  | 4865         | 5145         | 5145         | 5040         |
|                        | S5580-1A-227 | 227cm  | 31.2  | 5560         | 5880         | 5880         | 5760         |
|                        | S5580-1A-255 | 255cm  | 35.1  | 6255         | 6615         | 6615         | 6480         |
|                        | S5580-1A-283 | 283cm  | 39    | 6950         | 7350         | 7350         | 7200         |
|                        | S5580-1A-311 | 311cm  | 42.9  | 7645         | 8085         | 8085         | 7920         |
|                        | S5580-1A-339 | 339cm  | 46.8  | 8340         | 8820         | 8820         | 8640         |
|                        | S5580-1A-367 | 367cm  | 50.7  | 9035         | 9555         | 9555         | 9360         |
|                        | S5580-1A-395 | 395cm  | 54.6  | 9730         | 10290        | 10290        | 10080        |
|                        | S5580-1A-423 | 423cm  | 58.5  | 10425        | 11025        | 11025        | 10800        |
| S5580-1A-451           | 451cm        | 62.4   | 11120 | 11760        | 11760        | 11520        |              |

wattage: 13.5 W/m

|              |       |      |       |       |       |       |
|--------------|-------|------|-------|-------|-------|-------|
| S5580-1B-59  | 59cm  | 11.6 | 1960  | 2070  | 2070  | 2020  |
| S5580-1B-87  | 87cm  | 17.4 | 2940  | 3105  | 3105  | 3030  |
| S5580-1B-115 | 115cm | 23.2 | 3920  | 4140  | 4140  | 4040  |
| S5580-1B-143 | 143cm | 29   | 4900  | 5175  | 5175  | 5050  |
| S5580-1B-171 | 171cm | 34.8 | 5880  | 6210  | 6210  | 6060  |
| S5580-1B-199 | 199cm | 40.6 | 6860  | 7245  | 7245  | 7070  |
| S5580-1B-227 | 227cm | 46.4 | 7840  | 8280  | 8280  | 8080  |
| S5580-1B-255 | 255cm | 52.2 | 8820  | 9315  | 9315  | 9090  |
| S5580-1B-283 | 283cm | 58   | 9800  | 10350 | 10350 | 10100 |
| S5580-1B-311 | 311cm | 63.8 | 10780 | 11385 | 11385 | 11110 |
| S5580-1B-339 | 339cm | 69.6 | 11760 | 12420 | 12420 | 12120 |
| S5580-1B-367 | 367cm | 75.4 | 12740 | 13455 | 13455 | 13130 |
| S5580-1B-395 | 395cm | 81.2 | 13720 | 14490 | 14490 | 14140 |
| S5580-1B-423 | 423cm | 87   | 14700 | 15525 | 15525 | 15150 |
| S5580-1B-451 | 451cm | 92.8 | 15680 | 16560 | 16560 | 16160 |

wattage: 20 W/m

Το φωτιστικό είναι διαθέσιμο σε μήκος πολλαπλάσιο των 14 εκατοστών  
 The illuminant is available in lengths that are multiples of 14 centimeters.

## NILE 55×80 SUSPENDED / Lumen output tables

|                        | code         | length | watt  | lumens<br>3000K | lumens<br>4000K | lumens<br>5000K | lumens<br>6500K |
|------------------------|--------------|--------|-------|-----------------|-----------------|-----------------|-----------------|
| CATEGORY 2A 350mA (2A) | S5580-2A-59  | 59cm   | 23.6  | 4080            | 4380            | 4380            | 4080            |
|                        | S5580-2A-87  | 87cm   | 35.4  | 6120            | 6570            | 6570            | 6120            |
|                        | S5580-2A-115 | 115cm  | 47.2  | 8160            | 8760            | 8760            | 8160            |
|                        | S5580-2A-143 | 143cm  | 59    | 10200           | 10950           | 10950           | 10200           |
|                        | S5580-2A-171 | 171cm  | 70.8  | 12240           | 13140           | 13140           | 12240           |
|                        | S5580-2A-199 | 199cm  | 82.6  | 14280           | 15330           | 15330           | 14280           |
|                        | S5580-2A-227 | 227cm  | 94.4  | 16320           | 17520           | 17520           | 16320           |
|                        | S5580-2A-255 | 255cm  | 106.2 | 18360           | 19710           | 19710           | 18360           |
|                        | S5580-2A-283 | 283cm  | 118   | 20400           | 21900           | 21900           | 20400           |
|                        | S5580-2A-311 | 311cm  | 129.8 | 22440           | 24090           | 24090           | 22440           |
|                        | S5580-2A-339 | 339cm  | 141.6 | 24480           | 26280           | 26280           | 24480           |
|                        | S5580-2A-367 | 367cm  | 153.4 | 26520           | 28470           | 28470           | 26520           |
|                        | S5580-2A-395 | 395cm  | 165.2 | 28560           | 30660           | 30660           | 28560           |
|                        | S5580-2A-423 | 423cm  | 177   | 30600           | 32850           | 32850           | 30600           |
| S5580-2A-451           | 451cm        | 188.8  | 32640 | 35040           | 35040           | 32640           |                 |

wattage: 40.5 W/m

|                        |              |       |       |       |       |       |       |
|------------------------|--------------|-------|-------|-------|-------|-------|-------|
| CATEGORY 2B 500mA (2B) | S5580-2B-59  | 59cm  | 35    | 5700  | 6140  | 6140  | 5700  |
|                        | S5580-2B-87  | 87cm  | 52.5  | 8550  | 9210  | 9210  | 8550  |
|                        | S5580-2B-115 | 115cm | 70    | 11400 | 12280 | 12280 | 11400 |
|                        | S5580-2B-143 | 143cm | 87.5  | 14250 | 15350 | 15350 | 14250 |
|                        | S5580-2B-171 | 171cm | 105   | 17100 | 18420 | 18420 | 17100 |
|                        | S5580-2B-199 | 199cm | 122.5 | 19950 | 21490 | 21490 | 19950 |
|                        | S5580-2B-227 | 227cm | 140   | 22800 | 24560 | 24560 | 22800 |
|                        | S5580-2B-255 | 255cm | 157.5 | 25650 | 27630 | 27630 | 25650 |
|                        | S5580-2B-283 | 283cm | 175   | 28500 | 30700 | 30700 | 28500 |
|                        | S5580-2B-311 | 311cm | 192.5 | 31350 | 33770 | 33770 | 31350 |
|                        | S5580-2B-339 | 339cm | 210   | 34200 | 36840 | 36840 | 34200 |
|                        | S5580-2B-367 | 367cm | 227.5 | 37050 | 39910 | 39910 | 37050 |
|                        | S5580-2B-395 | 395cm | 245   | 39900 | 42980 | 42980 | 39900 |
|                        | S5580-2B-423 | 423cm | 262.5 | 42750 | 46050 | 46050 | 42750 |
| S5580-2B-451           | 451cm        | 280   | 45600 | 49120 | 49120 | 45600 |       |

wattage: 60.5 W/m

Το φωτιστικό είναι διαθέσιμο σε μήκος πολλαπλάσιο των 14 εκατοστών

The illuminant is available in lengths that are multiples of 14 centimeters.





SUSPENDED





UPDOWN

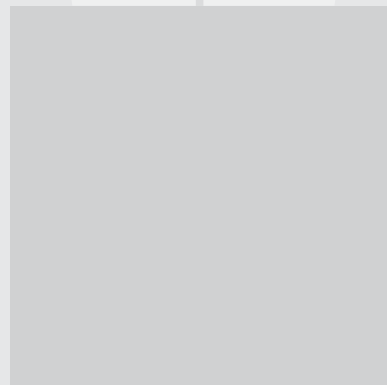

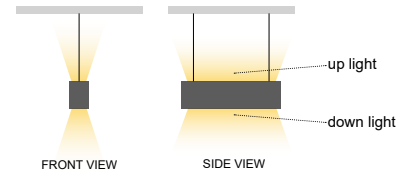
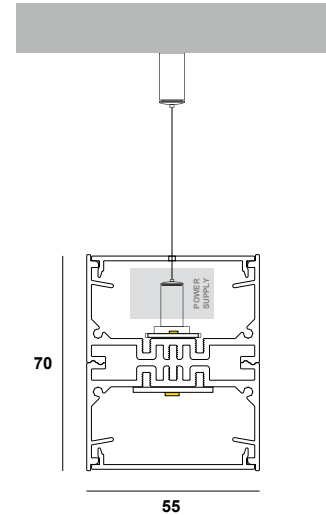

U5570 - XX - XX - XXX - XX - XX - XX - XX - X

- (a) Κωδικός Γραμμικού  
Linear Code
- (b) Κατηγορία downlight  
Category downlight
- (c) Ισχύς uplight  
Wattage uplight
- (d) Μήκος  
Length
- (e) CCT downlight
- (f) CCT uplight
- (g) Χρώμα προφίλ  
Profile color
- (h) Κάλυμμα  
Cover
- (i) Αυτομείωση έντασης φωτός  
Dimming

**Παράδειγμα κωδικού / Code example**

LINEAR 55×70 UPDOWN 1A + 6W/m Uplight 85cm 3000K Downlight 3000K Uplight Black with Diffuser Dimmable  
SKU: U5570-1A-6W-85-3-3-BL-C1-D

| material           | Pcb details                | CRI                         | lumen output / W | Dimming options  |
|--------------------|----------------------------|-----------------------------|------------------|--|
| Extruded aluminium | Zhaga-Compliant Dimensions | Ra>80<br>(Ra>90 on request) | up to 195 Lm/W   | Push<br>DALI<br>TRIAC 0/1-10V<br>CASAMBI<br>Analog 0/1-10V |

| CCT down lighting          | wattage up lighting | CCT up lighting                     | profile color | covers for down lighting       |
|----------------------------|---------------------|-------------------------------------|---------------|--------------------------------|
| 3000K (3)                  | 6 W/m White (6W)    | 3000K (3) for up lighting 6W 9W 12W | Anodised (AN) | Acrylic Diffuser ( -C1-)       |
| 4000K (4)                  | 9 W/m White (9W)    | 4000K (4) for up lighting 6W 9W 12W | Black (BL)    |                                |
| 5000K (5)                  | 12 W/m White (12W)  | 5000K (5) for up lighting 6W 9W 12W | White (WH)    |                                |
| 6500K (6)                  | 12 W/m RGBW (12C)   | 6500K (6) for up lighting 6W 9W 12W | RAL (RL)      | Acrylic Microprismatic ( -C2-) |
| TUNABLE 2700K - 6500K (TN) | 16 W/m RGB (16C)    | RGBCW (C2) for up lighting 12C      |               |                                |
|                            |                     | RGBWW (C3) for up lighting 12C      |               |                                |
|                            |                     | RGB for up lighting 16C             |               |                                |

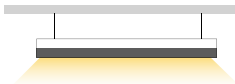

## DOWN LIGHT WATTAGE - LUMENS TABLE

| CATEGORY 1A 350mA (1A) | code            | length | watt | lumens 3000K | lumens 4000K | lumens 5000K | lumens 6500K |
|------------------------|-----------------|--------|------|--------------|--------------|--------------|--------------|
|                        | U5570-1A-__-57  | 57cm   | 7.8  | 1390         | 1470         | 1470         | 1440         |
|                        | U5570-1A-__-85  | 85cm   | 11.7 | 2085         | 2205         | 2205         | 2160         |
|                        | U5570-1A-__-113 | 113cm  | 15.6 | 2780         | 2940         | 2940         | 2880         |
|                        | U5570-1A-__-141 | 141cm  | 19.5 | 3475         | 3675         | 3675         | 3600         |
|                        | U5570-1A-__-169 | 169cm  | 23.4 | 4170         | 4410         | 4410         | 4320         |
|                        | U5570-1A-__-197 | 197cm  | 27.3 | 4865         | 5145         | 5145         | 5040         |
|                        | U5570-1A-__-225 | 225cm  | 31.2 | 5560         | 5880         | 5880         | 5760         |
|                        | U5570-1A-__-253 | 253cm  | 35.1 | 6255         | 6615         | 6615         | 6480         |
|                        | U5570-1A-__-281 | 281cm  | 39   | 6950         | 7350         | 7350         | 7200         |
|                        | U5570-1A-__-309 | 309cm  | 42.9 | 7645         | 8085         | 8085         | 7920         |
|                        | U5570-1A-__-337 | 337cm  | 46.8 | 8340         | 8820         | 8820         | 8640         |
|                        | U5570-1A-__-365 | 365cm  | 50.7 | 9035         | 9555         | 9555         | 9360         |
|                        | U5570-1A-__-393 | 393cm  | 54.6 | 9730         | 10290        | 10290        | 10080        |
|                        | U5570-1A-__-421 | 421cm  | 58.5 | 10425        | 11025        | 11025        | 10800        |
|                        | U5570-1A-__-449 | 449cm  | 62.4 | 11120        | 11760        | 11760        | 11520        |

| CATEGORY 1B 500mA (1B) | code            | length | watt | lumens 3000K | lumens 4000K | lumens 5000K | lumens 6500K |
|------------------------|-----------------|--------|------|--------------|--------------|--------------|--------------|
|                        | U5570-1B-__-57  | 57cm   | 11.6 | 1960         | 2070         | 2070         | 2020         |
|                        | U5570-1B-__-85  | 85cm   | 17.4 | 2940         | 3105         | 3105         | 3030         |
|                        | U5570-1B-__-113 | 113cm  | 23.2 | 3920         | 4140         | 4140         | 4040         |
|                        | U5570-1B-__-141 | 141cm  | 29   | 4900         | 5175         | 5175         | 5050         |
|                        | U5570-1B-__-169 | 169cm  | 34.8 | 5880         | 6210         | 6210         | 6060         |
|                        | U5570-1B-__-197 | 197cm  | 40.6 | 6860         | 7245         | 7245         | 7070         |
|                        | U5570-1B-__-225 | 225cm  | 46.4 | 7840         | 8280         | 8280         | 8080         |
|                        | U5570-1B-__-253 | 253cm  | 52.2 | 8820         | 9315         | 9315         | 9090         |
|                        | U5570-1B-__-281 | 281cm  | 58   | 9800         | 10350        | 10350        | 10100        |
|                        | U5570-1B-__-309 | 309cm  | 63.8 | 10780        | 11385        | 11385        | 11110        |
|                        | U5570-1B-__-337 | 337cm  | 69.6 | 11760        | 12420        | 12420        | 12120        |
|                        | U5570-1B-__-365 | 365cm  | 75.4 | 12740        | 13455        | 13455        | 13130        |
|                        | U5570-1B-__-393 | 393cm  | 81.2 | 13720        | 14490        | 14490        | 14140        |
|                        | U5570-1B-__-421 | 421cm  | 87   | 14700        | 15525        | 15525        | 15150        |
|                        | U5570-1B-__-449 | 449cm  | 92.8 | 15680        | 16560        | 16560        | 16160        |

| CATEGORY 2A 350mA (2A) | code            | length | watt  | lumens 3000K | lumens 4000K | lumens 5000K | lumens 6500K |
|------------------------|-----------------|--------|-------|--------------|--------------|--------------|--------------|
|                        | U5570-2A-__-57  | 57cm   | 23.6  | 4080         | 4380         | 4380         | 4080         |
|                        | U5570-2A-__-85  | 85cm   | 35.4  | 6120         | 6570         | 6570         | 6120         |
|                        | U5570-2A-__-113 | 113cm  | 47.2  | 8160         | 8760         | 8760         | 8160         |
|                        | U5570-2A-__-141 | 141cm  | 59    | 10200        | 10950        | 10950        | 10200        |
|                        | U5570-2A-__-169 | 169cm  | 70.8  | 12240        | 13140        | 13140        | 12240        |
|                        | U5570-2A-__-197 | 197cm  | 82.6  | 14280        | 15330        | 15330        | 14280        |
|                        | U5570-2A-__-225 | 225cm  | 94.4  | 16320        | 17520        | 17520        | 16320        |
|                        | U5570-2A-__-253 | 253cm  | 106.2 | 18360        | 19710        | 19710        | 18360        |
|                        | U5570-2A-__-281 | 281cm  | 118   | 20400        | 21900        | 21900        | 20400        |
|                        | U5570-2A-__-309 | 309cm  | 129.8 | 22440        | 24090        | 24090        | 22440        |
|                        | U5570-2A-__-337 | 337cm  | 141.6 | 24480        | 26280        | 26280        | 24480        |
|                        | U5570-2A-__-365 | 365cm  | 153.4 | 26520        | 28470        | 28470        | 26520        |
|                        | U5570-2A-__-393 | 393cm  | 165.2 | 28560        | 30660        | 30660        | 28560        |
|                        | U5570-2A-__-421 | 421cm  | 177   | 30600        | 32850        | 32850        | 30600        |
|                        | U5570-2A-__-449 | 449cm  | 188.8 | 32640        | 35040        | 35040        | 32640        |

| CATEGORY 2B 500mA (2B) | code            | length | watt  | lumens 3000K | lumens 4000K | lumens 5000K | lumens 6500K |
|------------------------|-----------------|--------|-------|--------------|--------------|--------------|--------------|
|                        | U5570-2B-__-57  | 57cm   | 35    | 5700         | 6140         | 6140         | 5700         |
|                        | U5570-2B-__-85  | 85cm   | 52.5  | 8550         | 9210         | 9210         | 8550         |
|                        | U5570-2B-__-113 | 113cm  | 70    | 11400        | 12280        | 12280        | 11400        |
|                        | U5570-2B-__-141 | 141cm  | 87.5  | 14250        | 15350        | 15350        | 14250        |
|                        | U5570-2B-__-169 | 169cm  | 105   | 17100        | 18420        | 18420        | 17100        |
|                        | U5570-2B-__-197 | 197cm  | 122.5 | 19950        | 21490        | 21490        | 19950        |
|                        | U5570-2B-__-225 | 225cm  | 140   | 22800        | 24560        | 24560        | 22800        |
|                        | U5570-2B-__-253 | 253cm  | 157.5 | 25650        | 27630        | 27630        | 25650        |
|                        | U5570-2B-__-281 | 281cm  | 175   | 28500        | 30700        | 30700        | 28500        |
|                        | U5570-2B-__-309 | 309cm  | 192.5 | 31350        | 33770        | 33770        | 31350        |
|                        | U5570-2B-__-337 | 337cm  | 210   | 34200        | 36840        | 36840        | 34200        |
|                        | U5570-2B-__-365 | 365cm  | 227.5 | 37050        | 39910        | 39910        | 37050        |
|                        | U5570-2B-__-393 | 393cm  | 245   | 39900        | 42980        | 42980        | 39900        |
|                        | U5570-2B-__-421 | 421cm  | 262.5 | 42750        | 46050        | 46050        | 42750        |
|                        | U5570-2B-__-449 | 449cm  | 280   | 45600        | 49120        | 49120        | 45600        |

Το φωτιστικό είναι διαθέσιμο σε μήκος πολλαπλάσιο των 14 εκατοστών  
 The illuminant is available in lengths that are multiples of 14 centimeters.

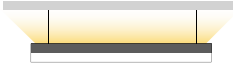

## UP LIGHT OPTIONS

## White

| LED STRIP 6W/m White (6W) | length | watt | CCT uplighting                                   |
|---------------------------|--------|------|--|
|                           | 57cm   | 3.6  | 3000K (3)<br>4000K (4)<br>5000K (5)<br>6500K (6) |
|                           | 85cm   | 5.3  |  |
|                           | 113cm  | 7    |  |
|                           | 141cm  | 8.6  |  |
|                           | 169cm  | 10.3 |  |
|                           | 197cm  | 12   |  |
|                           | 225cm  | 13.7 |  |
|                           | 253cm  | 15.4 |  |
|                           | 281cm  | 17   |  |
|                           | 309cm  | 18.7 |  |
|                           | 337cm  | 20.4 |  |
|                           | 365cm  | 22.1 |  |
|                           | 393cm  | 23.8 |  |
|                           | 421cm  | 25.4 |  |
| 449cm                     | 28.6   |      |  |

| LED STRIP 9W/m White (9W) | length | wattage | CCT uplighting                                   |
|---------------------------|--------|---------|--|
|                           | 57cm   | 5.4     | 3000K (3)<br>4000K (4)<br>5000K (5)<br>6500K (6) |
|                           | 85cm   | 7.9     |  |
|                           | 113cm  | 10.4    |  |
|                           | 141cm  | 13      |  |
|                           | 169cm  | 15.5    |  |
|                           | 197cm  | 18      |  |
|                           | 225cm  | 20.5    |  |
|                           | 253cm  | 23      |  |
|                           | 281cm  | 25.6    |  |
|                           | 309cm  | 28.1    |  |
|                           | 337cm  | 30.6    |  |
|                           | 365cm  | 33.1    |  |
|                           | 393cm  | 35.6    |  |
|                           | 421cm  | 38.2    |  |
| 449cm                     | 42.8   |         |  |

| LED STRIP 12W/m White (12W) | length | wattage | CCT uplighting                                   |
|-----------------------------|--------|---------|--|
|                             | 57cm   | 7.2     | 3000K (3)<br>4000K (4)<br>5000K (5)<br>6500K (6) |
|                             | 85cm   | 10.6    |  |
|                             | 113cm  | 13.9    |  |
|                             | 141cm  | 17.3    |  |
|                             | 169cm  | 20.6    |  |
|                             | 197cm  | 24      |  |
|                             | 225cm  | 27.4    |  |
|                             | 253cm  | 30.7    |  |
|                             | 281cm  | 34.1    |  |
|                             | 309cm  | 37.4    |  |
|                             | 337cm  | 40.8    |  |
|                             | 365cm  | 44.2    |  |
|                             | 393cm  | 47.5    |  |
|                             | 421cm  | 50.9    |  |
| 449cm                       | 57.1   |         |  |

## Colors

| LED STRIP 12W/m RGBW (12C) | length | wattage | CCT uplighting                       |
|----------------------------|--------|---------|--------------------------------------|
|                            | 57cm   | 7.2     | RGB + 6500K (C2)<br>RGB + 3000K (C3) |
|                            | 85cm   | 10.6    |                                      |
|                            | 113cm  | 13.9    |                                      |
|                            | 141cm  | 17.3    |                                      |
|                            | 169cm  | 20.6    |                                      |
|                            | 197cm  | 24      |                                      |
|                            | 225cm  | 27.4    |                                      |
|                            | 253cm  | 30.7    |                                      |
|                            | 281cm  | 34.1    |                                      |
|                            | 309cm  | 37.4    |                                      |
|                            | 337cm  | 40.8    |                                      |
|                            | 365cm  | 44.2    |                                      |
|                            | 393cm  | 47.5    |                                      |
|                            | 421cm  | 50.8    |                                      |
| 449cm                      | 57.1   |         |                                      |

| LED STRIP 16W/m RGB (16C) | length | wattage | CCT uplighting |
|---------------------------|--------|---------|----------------|
|                           | 57cm   | 9.6     | RGB            |
|                           | 85cm   | 14.1    |                |
|                           | 113cm  | 18.6    |                |
|                           | 141cm  | 23      |                |
|                           | 169cm  | 27.5    |                |
|                           | 197cm  | 32      |                |
|                           | 225cm  | 36.5    |                |
|                           | 253cm  | 41      |                |
|                           | 281cm  | 45.4    |                |
|                           | 309cm  | 49.9    |                |
|                           | 337cm  | 54.4    |                |
|                           | 365cm  | 58.9    |                |
|                           | 393cm  | 63.4    |                |
|                           | 421cm  | 67.8    |                |
| 449cm                     | 76.2   |         |                |

Το φωτιστικό είναι διαθέσιμο σε μήκος πολλαπλάσιο των 14 εκατοστών

The illuminant is available in lengths that are multiples of 14 centimeters.



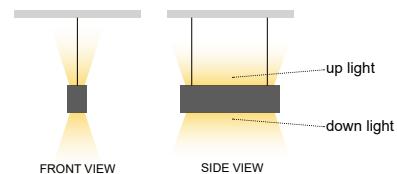
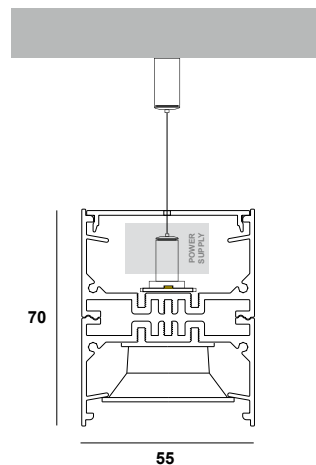

UD5570 - XX - XX - XXX - XX - XX - XX - XX - X - X

| (a)                              | (b)   | (c)                                    | (d)             | (e)              | (f)            | (g)                              | (h)                                 | (i)                                       | (j)                                       |
|----------------------------------|---|--|-----------------|------------------|----------------|----------------------------------|-------------------------------------|---|---|
| Κωδικός Γραμμικού<br>Linear Code | Κατηγορία<br>downlight<br>Category<br>downlight | Ισχύς<br>uplight<br>Wattage<br>uplight | Μήκος<br>Length | CCT<br>downlight | CCT<br>uplight | Γωνία<br>δέσμης<br>Beam<br>angle | Χρώμα<br>προφίλ<br>Profile<br>color | Χρώμα<br>Ρεφλέκτορα<br>Reflector<br>color | Αυξομείωση<br>έντασης<br>φωτός<br>Dimming |

**Παράδειγμα κωδικού / Code example**

DARK LINEAR 55×70 UPDOWN 1A + 6W/m Uplight 84.5cm 3000K (Down) 3000K (Up) 65° Black with Black Reflector Dimmable  
**SKU:** UD5570-1A-6W-85-3-3-60D-BL-1-D

| material                     | profile color | reflector color | Pcb details          | Dimming options |
|------------------------------|---------------|-----------------|----------------------|-----------------|
| Extruded aluminium / Plastic | Anodised (AN) | Black (1)       | SMD light & dark 7x1 | Push            |
|                              | Black (BL)    | White (1)       |                      | DALI            |
|                              | White (WH)    |                 |                      | TRIAC 0/1-10V   |
|                              | RAL (RL)      |                 |                      | CASAMBI         |
|                              |               |                 |                      | Analog 0/1-10V  |

| CCT down lighting          | beam angle down lighting | CRI                      | lumen output / W | wattage up lighting     | CCT up lighting                     |
|----------------------------|--------------------------|--------------------------|------------------|-------------------------|-------------------------------------|
| 3000K (3)                  | Medium 65° (60D)         | Ra>90 (Ra>80 on request) | up to 205 Lm/W   | 6 W/m White (6W)        | 3000K (3) for up lighting 6W 9W 12W |
| 4000K (4)                  | Wide 90° (90D)           |                          |                  | 9 W/m White (9W)        | 4000K (4) for up lighting 6W 9W 12W |
| 5000K (5)                  |                          |                          |                  | 12 W/m White (12W)      | 5000K (5) for up lighting 6W 9W 12W |
| 6500K (6)                  |                          |                          |                  | 12 W/m RGBW (12C)       | 6500K (6) for up lighting 6W 9W 12W |
| TUNABLE 2700K - 6500K (TN) |                          |                          |                  | 16 W/m RGB (16C)        | RGBCW (C2) for up lighting 12C      |
|                            |                          |                          |                  |                         | RGBWW (C3) for up lighting 12C      |
|                            |                          |                          |                  | RGB for up lighting 16C |                                     |



## DOWN LIGHT WATTAGE - LUMENS TABLE

| CATEGORY 1A 350mA (1A) | code              | length  | watt  | lumens 3000K (65°) | lumens 3000K (90°) | lumens 4000K (65°) | lumens 4000K (90°) |
|------------------------|-------------------|---------|-------|--------------------|--------------------|--------------------|--------------------|
|                        | UD5570-1A-_-56.5  | 56.5cm  | 13.4  | 1702               | 1680               | 1774               | 1752               |
|                        | UD5570-1A-_-84.5  | 84.5cm  | 20.1  | 2553               | 2520               | 2661               | 2628               |
|                        | UD5570-1A-_-112.5 | 112.5cm | 26.8  | 3404               | 3360               | 3548               | 3504               |
|                        | UD5570-1A-_-140.5 | 140.5cm | 33.5  | 4255               | 4200               | 4435               | 4380               |
|                        | UD5570-1A-_-168.5 | 168.5cm | 40.2  | 5106               | 5040               | 5322               | 5256               |
|                        | UD5570-1A-_-196.5 | 196.5cm | 46.9  | 5957               | 5880               | 6209               | 6132               |
|                        | UD5570-1A-_-224.5 | 224.5cm | 53.6  | 6808               | 6720               | 7096               | 7008               |
|                        | UD5570-1A-_-252.5 | 252.5cm | 60.3  | 7659               | 7560               | 7983               | 7884               |
|                        | UD5570-1A-_-280.5 | 280.5cm | 67    | 8510               | 8400               | 8870               | 8760               |
|                        | UD5570-1A-_-308.5 | 308.5cm | 73.7  | 9361               | 9240               | 9757               | 9636               |
|                        | UD5570-1A-_-336.5 | 336.5cm | 80.4  | 10212              | 10080              | 10644              | 10512              |
|                        | UD5570-1A-_-364.5 | 364.5cm | 87.1  | 11063              | 10920              | 11531              | 11388              |
|                        | UD5570-1A-_-392.5 | 392.5cm | 93.8  | 11914              | 11760              | 12418              | 12264              |
|                        | UD5570-1A-_-420.5 | 420.5cm | 100.5 | 12765              | 12600              | 13305              | 13140              |
|                        | UD5570-1A-_-448.5 | 448.5cm | 107.2 | 13616              | 13440              | 14192              | 14016              |

| CATEGORY 1B 500mA (1B) | code              | length  | watt  | lumens 3000K (65°) | lumens 3000K (90°) | lumens 4000K (65°) | lumens 4000K (90°) |
|------------------------|-------------------|---------|-------|--------------------|--------------------|--------------------|--------------------|
|                        | UD5570-1B-_-56.5  | 56.5cm  | 19.8  | 2398               | 2368               | 2512               | 2480               |
|                        | UD5570-1B-_-84.5  | 84.5cm  | 29.7  | 3597               | 3552               | 3768               | 3720               |
|                        | UD5570-1B-_-112.5 | 112.5cm | 39.6  | 4796               | 4736               | 5024               | 4960               |
|                        | UD5570-1B-_-140.5 | 140.5cm | 49.5  | 5995               | 5920               | 6280               | 6200               |
|                        | UD5570-1B-_-168.5 | 168.5cm | 59.4  | 7194               | 7104               | 7536               | 7440               |
|                        | UD5570-1B-_-196.5 | 196.5cm | 69.3  | 8393               | 8288               | 8792               | 8680               |
|                        | UD5570-1B-_-224.5 | 224.5cm | 79.2  | 9592               | 9472               | 10048              | 9920               |
|                        | UD5570-1B-_-252.5 | 252.5cm | 89.1  | 10791              | 10656              | 11304              | 11160              |
|                        | UD5570-1B-_-280.5 | 280.5cm | 99    | 11990              | 11840              | 12560              | 12400              |
|                        | UD5570-1B-_-308.5 | 308.5cm | 108.9 | 13189              | 13024              | 13816              | 13640              |
|                        | UD5570-1B-_-336.5 | 336.5cm | 118.8 | 14388              | 14208              | 15072              | 14880              |
|                        | UD5570-1B-_-364.5 | 364.5cm | 128.7 | 15587              | 15392              | 16328              | 16120              |
|                        | UD5570-1B-_-392.5 | 392.5cm | 138.6 | 16786              | 16576              | 17584              | 17360              |
|                        | UD5570-1B-_-420.5 | 420.5cm | 148.5 | 17985              | 17760              | 18840              | 18600              |
|                        | UD5570-1B-_-448.5 | 448.5cm | 158.4 | 19184              | 18944              | 20096              | 19840              |

Το φωτιστικό είναι διαθέσιμο σε μήκος πολλαπλάσιο των 28 εκατοστών

The illuminant is available in lengths that are multiples of 28 centimeters.





UP LIGHT OPTIONS

White

| LED STRIP 6W/m White (6W) | length  | watt | CCT uplighting                                   |
|---------------------------|---------|------|--|
|                           | 56.5cm  | 3.6  | 3000K (3)<br>4000K (4)<br>5000K (5)<br>6500K (6) |
|                           | 84.5cm  | 5.3  |  |
|                           | 112.5cm | 7    |  |
|                           | 140.5cm | 8.6  |  |
|                           | 168.5cm | 10.3 |  |
|                           | 196.5cm | 12   |  |
|                           | 224.5cm | 13.7 |  |
|                           | 252.5cm | 15.4 |  |
|                           | 280.5cm | 17   |  |
|                           | 308.5cm | 18.7 |  |
|                           | 336.5cm | 20.4 |  |
|                           | 364.5cm | 22.1 |  |
|                           | 392.5cm | 23.8 |  |
|                           | 420.5cm | 25.4 |  |
| 448.5cm                   | 28.6    |      |  |

| LED STRIP 9W/m White (9W) | length  | wattage | CCT uplighting                                   |
|---------------------------|---------|---------|--|
|                           | 56.5cm  | 5.4     | 3000K (3)<br>4000K (4)<br>5000K (5)<br>6500K (6) |
|                           | 84.5cm  | 7.9     |  |
|                           | 112.5cm | 10.4    |  |
|                           | 140.5cm | 13      |  |
|                           | 168.5cm | 15.5    |  |
|                           | 196.5cm | 18      |  |
|                           | 224.5cm | 20.5    |  |
|                           | 252.5cm | 23      |  |
|                           | 280.5cm | 25.6    |  |
|                           | 308.5cm | 28.1    |  |
|                           | 336.5cm | 30.6    |  |
|                           | 364.5cm | 33.1    |  |
|                           | 392.5cm | 35.6    |  |
|                           | 420.5cm | 38.2    |  |
| 448.5cm                   | 42.8    |         |  |

| LED STRIP 12W/m White (12W) | length  | wattage | CCT uplighting                                   |
|-----------------------------|---------|---------|--|
|                             | 56.5cm  | 7.2     | 3000K (3)<br>4000K (4)<br>5000K (5)<br>6500K (6) |
|                             | 84.5cm  | 10.6    |  |
|                             | 112.5cm | 13.9    |  |
|                             | 140.5cm | 17.3    |  |
|                             | 168.5cm | 20.6    |  |
|                             | 196.5cm | 24      |  |
|                             | 224.5cm | 27.4    |  |
|                             | 252.5cm | 30.7    |  |
|                             | 280.5cm | 34.1    |  |
|                             | 308.5cm | 37.4    |  |
|                             | 336.5cm | 40.8    |  |
|                             | 364.5cm | 44.2    |  |
|                             | 392.5cm | 47.5    |  |
|                             | 420.5cm | 50.9    |  |
| 448.5cm                     | 57.1    |         |  |

Colors

| LED STRIP 12W/m RGBW (12C) | length  | wattage | CCT uplighting                       |
|----------------------------|---------|---------|--------------------------------------|
|                            | 56.5cm  | 7.2     | RGB + 6500K (C2)<br>RGB + 3000K (C3) |
|                            | 84.5cm  | 10.6    |                                      |
|                            | 112.5cm | 13.9    |                                      |
|                            | 140.5cm | 17.3    |                                      |
|                            | 168.5cm | 20.6    |                                      |
|                            | 196.5cm | 24      |                                      |
|                            | 224.5cm | 27.4    |                                      |
|                            | 252.5cm | 30.7    |                                      |
|                            | 280.5cm | 34.1    |                                      |
|                            | 308.5cm | 37.4    |                                      |
|                            | 336.5cm | 40.8    |                                      |
|                            | 364.5cm | 44.2    |                                      |
|                            | 392.5cm | 47.5    |                                      |
|                            | 420.5cm | 50.8    |                                      |
| 448.5cm                    | 57.1    |         |                                      |

| LED STRIP 16W/m RGB (16C) | length  | wattage | CCT uplighting |
|---------------------------|---------|---------|----------------|
|                           | 56.5cm  | 9.6     | RGB            |
|                           | 84.5cm  | 14.1    |                |
|                           | 112.5cm | 18.6    |                |
|                           | 140.5cm | 23      |                |
|                           | 168.5cm | 27.5    |                |
|                           | 196.5cm | 32      |                |
|                           | 224.5cm | 36.5    |                |
|                           | 252.5cm | 41      |                |
|                           | 280.5cm | 45.4    |                |
|                           | 308.5cm | 49.9    |                |
|                           | 336.5cm | 54.4    |                |
|                           | 364.5cm | 58.9    |                |
|                           | 392.5cm | 63.4    |                |
|                           | 420.5cm | 67.8    |                |
| 448.5cm                   | 76.2    |         |                |

Το φωτιστικό είναι διαθέσιμο σε μήκος πολλαπλάσιο των 28 εκατοστών  
 The illuminant is available in lengths that are multiples of 28 centimeters.



SUSPENDED



# CURVE

LIGHTING SYSTEMS



# CIRCLES

Τα Circle® είναι ιδανικά για το φωτισμό μεγάλων επιφανειών. Μπορούν να χρησιμοποιηθούν σε δημόσια πολιτιστικά κτίρια, μουσεία και γκαλερί. Είναι ένα φωτιστικό που χρησιμοποιείται κυρίως από τους σχεδιαστές φωτισμού για να αναδείξουν επιφάνειες κτιρίων ή αρχιτεκτονικές κατασκευές. Αναζητώντας συνεχώς απλούστερους και πρακτικούς τρόπους για τη δημιουργία προφίλ φωτιστικών που να εφαρμόζουν όσο πιο εύκολα γίνεται, η **BARISLIGHT®** κατέληξε σε μια καινοτόμα ιδέα κυκλικών φωτιστικών που μπορεί να προσφέρει εξαιρετική φωτεινότητα και στυλ στο χώρο.

---

Circle® are ideal for lighting large surfaces. They can be used in public cultural buildings, museums and galleries. It is a luminaire mainly used by lighting designers to highlight building surfaces or architectural structures. Constantly looking for simpler and more practical ways to create lighting profiles that fit as easily as possible, **BARISLIGHT®** has come up with an innovative concept of circular lighting that can provide exceptional brightness and style to the space.

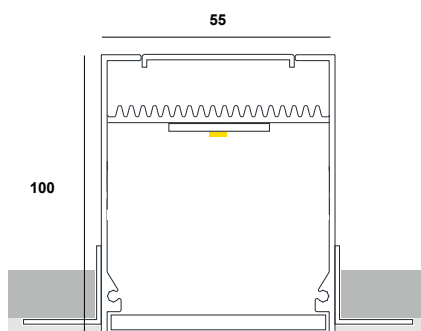

# TC55100 - XX - XXX - X - X

- (a)**  
Κωδικός Γραμμικού  
Linear Code
- (b)**  
Κατηγορία  
Category
- (c)**  
Διάμετρος  
Diameter
- (d)**  
Θερμοκρασία  
φωτός  
Color  
Temperature
- (f)**  
Αυξομείωση  
έντασης φωτός  
Dimming

**Παράδειγμα κωδικού / Code example**

LINEAR 30×15 TRIMLESS 1A 90cm 3000K Dimmable  
SKU: T3015-1A-90-3-D

| material           | pcb details                | CRI                                 | lumen output / W |
|--------------------|----------------------------|-------------------------------------|------------------|
| Extruded aluminium | Zhaga-Compliant Dimensions | Ra>80 ( <b>Ra&gt;90</b> on request) | up to 195 Lm/W   |

| covers  | CCT                        | dimming options (D) |
|---|----------------------------|---------------------|
| <br>Diffuser 5mm | 3000K (3)                  | Push                |
|   | 4000K (4)                  | DALI                |
|   | 5000K (5)                  | TRIAC 0/1-10V       |
|   | 6500K (6)                  | CASAMBI             |
|   | TUNABLE 2700K - 6500K (TN) | Analog 0/1-10V      |

CIRCLES



**CIRCLE 55×100 TRIMLESS / Lumen output tables**

| CATEGORY 1A 350mA (1A) | code           | diameter | watt  | lumens 3000K | lumens 4000K | lumens 5000K | lumens 6500K |
|------------------------|----------------|----------|-------|--------------|--------------|--------------|--------------|
|                        | TC55100-1A-50  | 50cm     | 18    | 3150         | 3330         | 3330         | 3240         |
|                        | TC55100-1A-60  | 60cm     | 22    | 3850         | 4070         | 4070         | 3960         |
|                        | TC55100-1A-70  | 70cm     | 28    | 4900         | 5180         | 5180         | 5040         |
|                        | TC55100-1A-80  | 80cm     | 32    | 5600         | 5920         | 5920         | 5760         |
|                        | TC55100-1A-90  | 90cm     | 36    | 6300         | 6660         | 6660         | 6480         |
|                        | TC55100-1A-100 | 100cm    | 40    | 7000         | 7400         | 7400         | 7200         |
|                        | TC55100-1A-110 | 110cm    | 44    | 7700         | 8140         | 8140         | 7920         |
|                        | TC55100-1A-120 | 120cm    | 48    | 8400         | 8880         | 8880         | 8640         |
|                        | TC55100-1A-130 | 130cm    | 52    | 9100         | 9620         | 9620         | 9360         |
|                        | TC55100-1A-140 | 140cm    | 56    | 9800         | 10360        | 10360        | 10080        |
|                        | TC55100-1A-150 | 150cm    | 64    | 11200        | 11840        | 11840        | 11520        |
|                        | TC55100-1A-160 | 160cm    | 68    | 11900        | 12580        | 12580        | 12240        |
|                        | TC55100-1A-170 | 170cm    | 72    | 12600        | 13320        | 13320        | 12960        |
| TC55100-1A-180         | 180cm          | 76       | 13300 | 14060        | 14060        | 13680        |              |

|                        |                |       |       |       |       |       |       |
|------------------------|----------------|-------|-------|-------|-------|-------|-------|
| CATEGORY 1B 500mA (1B) | TC55100-1B-50  | 50cm  | 26.1  | 4410  | 4680  | 4680  | 4545  |
|                        | TC55100-1B-60  | 60cm  | 31.9  | 5390  | 5720  | 5720  | 5555  |
|                        | TC55100-1B-70  | 70cm  | 40.6  | 6860  | 7280  | 7280  | 7070  |
|                        | TC55100-1B-80  | 80cm  | 46.4  | 7840  | 8320  | 8320  | 8080  |
|                        | TC55100-1B-90  | 90cm  | 52.2  | 8820  | 9360  | 9360  | 9090  |
|                        | TC55100-1B-100 | 100cm | 58    | 9800  | 10400 | 10400 | 10100 |
|                        | TC55100-1B-110 | 110cm | 63.8  | 10780 | 11440 | 11440 | 11110 |
|                        | TC55100-1B-120 | 120cm | 69.6  | 11760 | 12480 | 12480 | 12120 |
|                        | TC55100-1B-130 | 130cm | 75.4  | 12740 | 13520 | 13520 | 13130 |
|                        | TC55100-1B-140 | 140cm | 81.2  | 13720 | 14560 | 14560 | 14140 |
|                        | TC55100-1B-150 | 150cm | 92.8  | 15680 | 16640 | 16640 | 16160 |
|                        | TC55100-1B-160 | 160cm | 98.6  | 16660 | 17680 | 17680 | 17170 |
|                        | TC55100-1B-170 | 170cm | 104.4 | 17640 | 18720 | 18720 | 18180 |
|                        | TC55100-1B-180 | 180cm | 110.2 | 18620 | 19760 | 19760 | 19190 |



**CIRCLE 55×100 TRIMLESS / Lumen output tables**

|                        | code           | diameter | watt | lumens<br>3000K | lumens<br>4000K | lumens<br>5000K | lumens<br>6500K |
|------------------------|----------------|----------|------|-----------------|-----------------|-----------------|-----------------|
| CATEGORY 2A 350mA (2A) | TC55100-2A-50  | 50cm     | 36   | 6300            | 6660            | 6660            | 6480            |
|                        | TC55100-2A-60  | 60cm     | 44   | 7700            | 8140            | 8140            | 7920            |
|                        | TC55100-2A-70  | 70cm     | 56   | 9800            | 10360           | 10360           | 10080           |
|                        | TC55100-2A-80  | 80cm     | 64   | 11200           | 11840           | 11840           | 11520           |
|                        | TC55100-2A-90  | 90cm     | 72   | 12600           | 13320           | 13320           | 12960           |
|                        | TC55100-2A-100 | 100cm    | 80   | 14000           | 14800           | 14800           | 14400           |
|                        | TC55100-2A-110 | 110cm    | 88   | 15400           | 16280           | 16280           | 15840           |
|                        | TC55100-2A-120 | 120cm    | 96   | 16800           | 17760           | 17760           | 17280           |
|                        | TC55100-2A-130 | 130cm    | 104  | 18200           | 19240           | 19240           | 18720           |
|                        | TC55100-2A-140 | 140cm    | 112  | 19600           | 20720           | 20720           | 20160           |
|                        | TC55100-2A-150 | 150cm    | 128  | 22400           | 23680           | 23680           | 23040           |
|                        | TC55100-2A-160 | 160cm    | 136  | 23800           | 25160           | 25160           | 24480           |
|                        | TC55100-2A-170 | 170cm    | 144  | 25200           | 26640           | 26640           | 25920           |
|                        | TC55100-2A-180 | 180cm    | 152  | 26600           | 28120           | 28120           | 27360           |

|                        |                |       |       |       |       |       |       |
|------------------------|----------------|-------|-------|-------|-------|-------|-------|
| CATEGORY 2B 500mA (2B) | TC55100-2B-50  | 50cm  | 52.2  | 8820  | 9360  | 9360  | 9090  |
|                        | TC55100-2B-60  | 60cm  | 63.8  | 10780 | 11440 | 11440 | 11110 |
|                        | TC55100-2B-70  | 70cm  | 81.2  | 13720 | 14560 | 14560 | 14140 |
|                        | TC55100-2B-80  | 80cm  | 92.8  | 15680 | 16640 | 16640 | 16160 |
|                        | TC55100-2B-90  | 90cm  | 104.4 | 17640 | 18720 | 18720 | 18180 |
|                        | TC55100-2B-100 | 100cm | 116   | 19600 | 20800 | 20800 | 20200 |
|                        | TC55100-2B-110 | 110cm | 127.6 | 21560 | 22880 | 22880 | 22220 |
|                        | TC55100-2B-120 | 120cm | 139.2 | 23520 | 24960 | 24960 | 24240 |
|                        | TC55100-2B-130 | 130cm | 150.8 | 25480 | 27040 | 27040 | 26260 |
|                        | TC55100-2B-140 | 140cm | 162.4 | 27440 | 29120 | 29120 | 28280 |
|                        | TC55100-2B-150 | 150cm | 185.6 | 31360 | 33280 | 33280 | 32320 |
|                        | TC55100-2B-160 | 160cm | 197.2 | 33320 | 35360 | 35360 | 34340 |
|                        | TC55100-2B-170 | 170cm | 208.8 | 35280 | 37440 | 37440 | 36360 |
|                        | TC55100-2B-180 | 180cm | 220.4 | 37240 | 39520 | 39520 | 38380 |

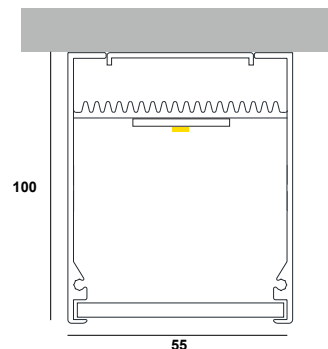

C55100 - XX - XXX - X - XX - X - XXX





- (a)  
Κωδικός Γραμμικού  
Linear Code
- (b)  
Κατηγορία  
Category
- (c)  
Διάμετρος  
Diameter
- (d)  
Θερμοκρασία  
φωτός  
Color  
Temperature
- (e)  
Χρώμα  
προφίλ  
Profile  
color
- (f)  
Αυξομείωση  
έντασης φωτός  
Dimming
- (g)  
Τοποθέτηση  
τροφοδοτικού  
Power supply  
placement

Παράδειγμα κωδικού / Code example

CIRCLE 55×100 1A Ø90cm 3000K Black Dimmable (Hidden Power supply)  
SKU: C55100-1A-90-3-BL-D-HP

| material           | pcb details                | CRI                      | lumen output / W |
|--------------------|----------------------------|--------------------------|------------------|
| Extruded aluminium | Zhaga-Compliant Dimensions | Ra>80 (Ra>90 on request) | up to 195 Lm/W   |

| covers  | CCT                           | profile color | dimming options (D) |
|---|-------------------------------|---------------|---------------------|
| <br>Diffuser 5mm | 3000K (3)                     | Anodised (AN) | Push                |
|   | 4000K (4)                     | Black (BL)    | DALI                |
|   | 5000K (5)                     | White (WH)    | TRIAC 0/1-10V       |
|   | 6500K (6)                     | RAL (RL)      | CASAMBI             |
|   | TUNABLE<br>2700K - 6500K (TN) |               | Analog 0/1-10V      |

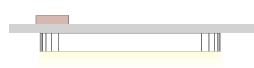
| power supply installation   |  |
|---|--|
| <p>Μέσα σε ροζέτα<br/>Inside a rosette</p>  <ul style="list-style-type: none"> <li> Κυκλική ροζέτα Ø400×40mm<br/>Circular rosette Ø400×40mm<br/><b>(-RP4-)</b></li> <li> Ορθογώνια ροζέτα 400×60×35mm<br/>Rectangular rosette 400×60×35mm<br/><b>(-RP5-)</b></li> <li> Ορθογώνια ροζέτα 600×80×35mm<br/>Rectangular rosette 600×80×35mm<br/><b>(-RP6-)</b></li> </ul> | <p>Κρυφό με πρόσβαση στο τροφοδοτικό<br/>Hidden with access to the power supply</p> <br><b>(-HP-)</b> |



CIRCLES

**CIRCLE 55×100** / Lumen output tables

| CATEGORY 1A 350mA (1A) | code          | diameter | watt  | lumens 3000K | lumens 4000K | lumens 5000K | lumens 6500K |
|------------------------|---------------|----------|-------|--------------|--------------|--------------|--------------|
|                        | C55100-1A-50  | 50cm     | 18    | 3150         | 3330         | 3330         | 3240         |
|                        | C55100-1A-60  | 60cm     | 22    | 3850         | 4070         | 4070         | 3960         |
|                        | C55100-1A-70  | 70cm     | 28    | 4900         | 5180         | 5180         | 5040         |
|                        | C55100-1A-80  | 80cm     | 32    | 5600         | 5920         | 5920         | 5760         |
|                        | C55100-1A-90  | 90cm     | 36    | 6300         | 6660         | 6660         | 6480         |
|                        | C55100-1A-100 | 100cm    | 40    | 7000         | 7400         | 7400         | 7200         |
|                        | C55100-1A-110 | 110cm    | 44    | 7700         | 8140         | 8140         | 7920         |
|                        | C55100-1A-120 | 120cm    | 48    | 8400         | 8880         | 8880         | 8640         |
|                        | C55100-1A-130 | 130cm    | 52    | 9100         | 9620         | 9620         | 9360         |
|                        | C55100-1A-140 | 140cm    | 56    | 9800         | 10360        | 10360        | 10080        |
|                        | C55100-1A-150 | 150cm    | 64    | 11200        | 11840        | 11840        | 11520        |
|                        | C55100-1A-160 | 160cm    | 68    | 11900        | 12580        | 12580        | 12240        |
|                        | C55100-1A-170 | 170cm    | 72    | 12600        | 13320        | 13320        | 12960        |
| C55100-1A-180          | 180cm         | 76       | 13300 | 14060        | 14060        | 13680        |              |

|               |       |       |       |       |       |       |
|---------------|-------|-------|-------|-------|-------|-------|
| C55100-1B-50  | 50cm  | 26.1  | 4410  | 4680  | 4680  | 4545  |
| C55100-1B-60  | 60cm  | 31.9  | 5390  | 5720  | 5720  | 5555  |
| C55100-1B-70  | 70cm  | 40.6  | 6860  | 7280  | 7280  | 7070  |
| C55100-1B-80  | 80cm  | 46.4  | 7840  | 8320  | 8320  | 8080  |
| C55100-1B-90  | 90cm  | 52.2  | 8820  | 9360  | 9360  | 9090  |
| C55100-1B-100 | 100cm | 58    | 9800  | 10400 | 10400 | 10100 |
| C55100-1B-110 | 110cm | 63.8  | 10780 | 11440 | 11440 | 11110 |
| C55100-1B-120 | 120cm | 69.6  | 11760 | 12480 | 12480 | 12120 |
| C55100-1B-130 | 130cm | 75.4  | 12740 | 13520 | 13520 | 13130 |
| C55100-1B-140 | 140cm | 81.2  | 13720 | 14560 | 14560 | 14140 |
| C55100-1B-150 | 150cm | 92.8  | 15680 | 16640 | 16640 | 16160 |
| C55100-1B-160 | 160cm | 98.6  | 16660 | 17680 | 17680 | 17170 |
| C55100-1B-170 | 170cm | 104.4 | 17640 | 18720 | 18720 | 18180 |
| C55100-1B-180 | 180cm | 110.2 | 18620 | 19760 | 19760 | 19190 |

**CIRCLE 55×100 / Lumen output tables**

| CATEGORY 2A 350mA (2A) | code          | diameter | watt  | lumens 3000K | lumens 4000K | lumens 5000K | lumens 6500K |
|------------------------|---------------|----------|-------|--------------|--------------|--------------|--------------|
|                        | C55100-2A-50  | 50cm     | 36    | 6300         | 6660         | 6660         | 6480         |
|                        | C55100-2A-60  | 60cm     | 44    | 7700         | 8140         | 8140         | 7920         |
|                        | C55100-2A-70  | 70cm     | 56    | 9800         | 10360        | 10360        | 10080        |
|                        | C55100-2A-80  | 80cm     | 64    | 11200        | 11840        | 11840        | 11520        |
|                        | C55100-2A-90  | 90cm     | 72    | 12600        | 13320        | 13320        | 12960        |
|                        | C55100-2A-100 | 100cm    | 80    | 14000        | 14800        | 14800        | 14400        |
|                        | C55100-2A-110 | 110cm    | 88    | 15400        | 16280        | 16280        | 15840        |
|                        | C55100-2A-120 | 120cm    | 96    | 16800        | 17760        | 17760        | 17280        |
|                        | C55100-2A-130 | 130cm    | 104   | 18200        | 19240        | 19240        | 18720        |
|                        | C55100-2A-140 | 140cm    | 112   | 19600        | 20720        | 20720        | 20160        |
|                        | C55100-2A-150 | 150cm    | 128   | 22400        | 23680        | 23680        | 23040        |
|                        | C55100-2A-160 | 160cm    | 136   | 23800        | 25160        | 25160        | 24480        |
|                        | C55100-2A-170 | 170cm    | 144   | 25200        | 26640        | 26640        | 25920        |
| C55100-2A-180          | 180cm         | 152      | 26600 | 28120        | 28120        | 27360        |              |

|               |       |       |       |       |       |       |
|---------------|-------|-------|-------|-------|-------|-------|
| C55100-2B-50  | 50cm  | 52.2  | 8820  | 9360  | 9360  | 9090  |
| C55100-2B-60  | 60cm  | 63.8  | 10780 | 11440 | 11440 | 11110 |
| C55100-2B-70  | 70cm  | 81.2  | 13720 | 14560 | 14560 | 14140 |
| C55100-2B-80  | 80cm  | 92.8  | 15680 | 16640 | 16640 | 16160 |
| C55100-2B-90  | 90cm  | 104.4 | 17640 | 18720 | 18720 | 18180 |
| C55100-2B-100 | 100cm | 116   | 19600 | 20800 | 20800 | 20200 |
| C55100-2B-110 | 110cm | 127.6 | 21560 | 22880 | 22880 | 22220 |
| C55100-2B-120 | 120cm | 139.2 | 23520 | 24960 | 24960 | 24240 |
| C55100-2B-130 | 130cm | 150.8 | 25480 | 27040 | 27040 | 26260 |
| C55100-2B-140 | 140cm | 162.4 | 27440 | 29120 | 29120 | 28280 |
| C55100-2B-150 | 150cm | 185.6 | 31360 | 33280 | 33280 | 32320 |
| C55100-2B-160 | 160cm | 197.2 | 33320 | 35360 | 35360 | 34340 |
| C55100-2B-170 | 170cm | 208.8 | 35280 | 37440 | 37440 | 36360 |
| C55100-2B-180 | 180cm | 220.4 | 37240 | 39520 | 39520 | 38380 |

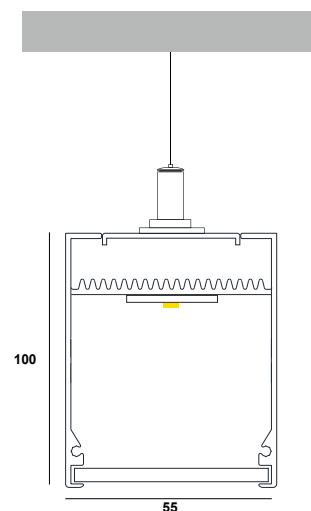
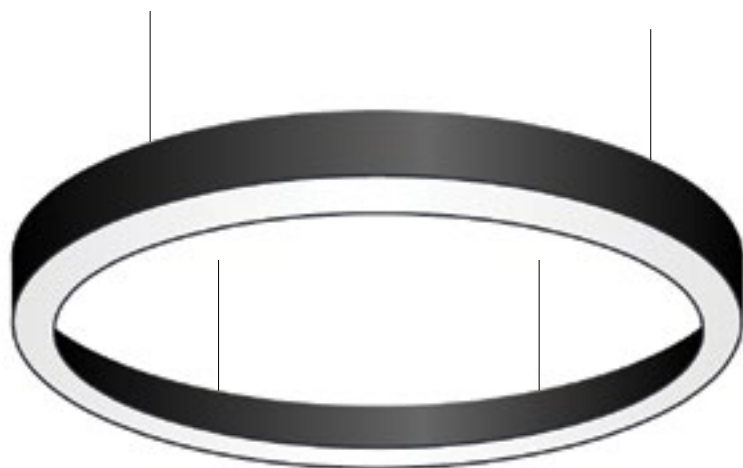

SC55100 - XX - XXX - X - XX - X - XXX



|                                  |                       |                       |  |                                     |  |   |
|----------------------------------|-----------------------|-----------------------|--|-------------------------------------|--|---|
| (a)                              | (b)                   | (c)                   | (d)  | (e)                                 | (f)                                    | (g)   |
| Κωδικός Γραμμικού<br>Linear Code | Κατηγορία<br>Category | Διάμετρος<br>Diameter | Θερμοκρασία<br>φωτός<br>Color<br>Temperature | Χρώμα<br>προφίλ<br>Profile<br>color | Αυξομείωση<br>έντασης φωτός<br>Dimming | Τοποθέτηση<br>τροφοδοτικού<br>Power supply<br>placement |

Παράδειγμα κωδικού / Code example

CIRCLE 55×100 SUSPENDED 1A Ø90cm 3000K Black Dimmable (Hidden Power supply)  
SKU: SC55100-1A-90-3-BL-D-HP

| material           | pcb details                | CRI                      | lumen output / W |
|--------------------|----------------------------|--------------------------|------------------|
| Extruded aluminium | Zhaga-Compliant Dimensions | Ra>80 (Ra>90 on request) | up to 195 Lm/W   |

| covers  | CCT                           | profile color | dimming options (D) |
|---|-------------------------------|---------------|---------------------|
|  <p>Diffuser 5mm</p> | 3000K (3)                     | Anodised (AN) | Push                |
|   | 4000K (4)                     | Black (BL)    | DALI                |
|   | 5000K (5)                     | White (WH)    | TRIAC 0/1-10V       |
|   | 6500K (6)                     | RAL (RL)      | CASAMBI             |
|   | TUNABLE<br>2700K - 6500K (TN) |               | Analog 0/1-10V      |

| power supply installation  |  |
|--|--|
| <p>Μέσα σε ροζέτα<br/>Inside a rosette</p>  | <p>Κυκλική ροζέτα Ø400×40mm<br/>Circular rosette Ø400×40mm<br/>(-RP4-)</p> <p>Ορθογώνια ροζέτα 400×60×35mm<br/>Rectangular rosette 400×60×35mm<br/>(-RP5-)</p> <p>Ορθογώνια ροζέτα 600×80×35mm<br/>Rectangular rosette 600×80×35mm<br/>(-RP6-)</p> |
|  | <p>Κρυφό με πρόσβαση στο τροφοδοτικό<br/>Hidden with access to the power supply</p>  <p>(-HP-)</p>  |





CIRCLES



**CIRCLE 55×100 SUSPENDED / Lumen output tables**

| CATEGORY 1A 350mA (1A) | code           | diameter | watt  | lumens 3000K | lumens 4000K | lumens 5000K | lumens 6500K |
|------------------------|----------------|----------|-------|--------------|--------------|--------------|--------------|
|                        | SC55100-1A-50  | 50cm     | 18    | 3150         | 3330         | 3330         | 3240         |
|                        | SC55100-1A-60  | 60cm     | 22    | 3850         | 4070         | 4070         | 3960         |
|                        | SC55100-1A-70  | 70cm     | 28    | 4900         | 5180         | 5180         | 5040         |
|                        | SC55100-1A-80  | 80cm     | 32    | 5600         | 5920         | 5920         | 5760         |
|                        | SC55100-1A-90  | 90cm     | 36    | 6300         | 6660         | 6660         | 6480         |
|                        | SC55100-1A-100 | 100cm    | 40    | 7000         | 7400         | 7400         | 7200         |
|                        | SC55100-1A-110 | 110cm    | 44    | 7700         | 8140         | 8140         | 7920         |
|                        | SC55100-1A-120 | 120cm    | 48    | 8400         | 8880         | 8880         | 8640         |
|                        | SC55100-1A-130 | 130cm    | 52    | 9100         | 9620         | 9620         | 9360         |
|                        | SC55100-1A-140 | 140cm    | 56    | 9800         | 10360        | 10360        | 10080        |
|                        | SC55100-1A-150 | 150cm    | 64    | 11200        | 11840        | 11840        | 11520        |
|                        | SC55100-1A-160 | 160cm    | 68    | 11900        | 12580        | 12580        | 12240        |
|                        | SC55100-1A-170 | 170cm    | 72    | 12600        | 13320        | 13320        | 12960        |
| SC55100-1A-180         | 180cm          | 76       | 13300 | 14060        | 14060        | 13680        |              |

|                        |                |       |       |       |       |       |       |
|------------------------|----------------|-------|-------|-------|-------|-------|-------|
| CATEGORY 1B 500mA (1B) | SC55100-1B-50  | 50cm  | 26.1  | 4410  | 4680  | 4680  | 4545  |
|                        | SC55100-1B-60  | 60cm  | 31.9  | 5390  | 5720  | 5720  | 5555  |
|                        | SC55100-1B-70  | 70cm  | 40.6  | 6860  | 7280  | 7280  | 7070  |
|                        | SC55100-1B-80  | 80cm  | 46.4  | 7840  | 8320  | 8320  | 8080  |
|                        | SC55100-1B-90  | 90cm  | 52.2  | 8820  | 9360  | 9360  | 9090  |
|                        | SC55100-1B-100 | 100cm | 58    | 9800  | 10400 | 10400 | 10100 |
|                        | SC55100-1B-110 | 110cm | 63.8  | 10780 | 11440 | 11440 | 11110 |
|                        | SC55100-1B-120 | 120cm | 69.6  | 11760 | 12480 | 12480 | 12120 |
|                        | SC55100-1B-130 | 130cm | 75.4  | 12740 | 13520 | 13520 | 13130 |
|                        | SC55100-1B-140 | 140cm | 81.2  | 13720 | 14560 | 14560 | 14140 |
|                        | SC55100-1B-150 | 150cm | 92.8  | 15680 | 16640 | 16640 | 16160 |
|                        | SC55100-1B-160 | 160cm | 98.6  | 16660 | 17680 | 17680 | 17170 |
|                        | SC55100-1B-170 | 170cm | 104.4 | 17640 | 18720 | 18720 | 18180 |
|                        | SC55100-1B-180 | 180cm | 110.2 | 18620 | 19760 | 19760 | 19190 |

**CIRCLE 55×100 SUSPENDED / Lumen output tables**

|                        | code           | diameter | watt | lumens<br>3000K | lumens<br>4000K | lumens<br>5000K | lumens<br>6500K |
|------------------------|----------------|----------|------|-----------------|-----------------|-----------------|-----------------|
| CATEGORY 2A 350mA (2A) | SC55100-2A-50  | 50cm     | 36   | 6300            | 6660            | 6660            | 6480            |
|                        | SC55100-2A-60  | 60cm     | 44   | 7700            | 8140            | 8140            | 7920            |
|                        | SC55100-2A-70  | 70cm     | 56   | 9800            | 10360           | 10360           | 10080           |
|                        | SC55100-2A-80  | 80cm     | 64   | 11200           | 11840           | 11840           | 11520           |
|                        | SC55100-2A-90  | 90cm     | 72   | 12600           | 13320           | 13320           | 12960           |
|                        | SC55100-2A-100 | 100cm    | 80   | 14000           | 14800           | 14800           | 14400           |
|                        | SC55100-2A-110 | 110cm    | 88   | 15400           | 16280           | 16280           | 15840           |
|                        | SC55100-2A-120 | 120cm    | 96   | 16800           | 17760           | 17760           | 17280           |
|                        | SC55100-2A-130 | 130cm    | 104  | 18200           | 19240           | 19240           | 18720           |
|                        | SC55100-2A-140 | 140cm    | 112  | 19600           | 20720           | 20720           | 20160           |
|                        | SC55100-2A-150 | 150cm    | 128  | 22400           | 23680           | 23680           | 23040           |
|                        | SC55100-2A-160 | 160cm    | 136  | 23800           | 25160           | 25160           | 24480           |
|                        | SC55100-2A-170 | 170cm    | 144  | 25200           | 26640           | 26640           | 25920           |
|                        | SC55100-2A-180 | 180cm    | 152  | 26600           | 28120           | 28120           | 27360           |

|                        |                |       |       |       |       |       |       |
|------------------------|----------------|-------|-------|-------|-------|-------|-------|
| CATEGORY 2B 500mA (2B) | SC55100-2B-50  | 50cm  | 52.2  | 8820  | 9360  | 9360  | 9090  |
|                        | SC55100-2B-60  | 60cm  | 63.8  | 10780 | 11440 | 11440 | 11110 |
|                        | SC55100-2B-70  | 70cm  | 81.2  | 13720 | 14560 | 14560 | 14140 |
|                        | SC55100-2B-80  | 80cm  | 92.8  | 15680 | 16640 | 16640 | 16160 |
|                        | SC55100-2B-90  | 90cm  | 104.4 | 17640 | 18720 | 18720 | 18180 |
|                        | SC55100-2B-100 | 100cm | 116   | 19600 | 20800 | 20800 | 20200 |
|                        | SC55100-2B-110 | 110cm | 127.6 | 21560 | 22880 | 22880 | 22220 |
|                        | SC55100-2B-120 | 120cm | 139.2 | 23520 | 24960 | 24960 | 24240 |
|                        | SC55100-2B-130 | 130cm | 150.8 | 25480 | 27040 | 27040 | 26260 |
|                        | SC55100-2B-140 | 140cm | 162.4 | 27440 | 29120 | 29120 | 28280 |
|                        | SC55100-2B-150 | 150cm | 185.6 | 31360 | 33280 | 33280 | 32320 |
|                        | SC55100-2B-160 | 160cm | 197.2 | 33320 | 35360 | 35360 | 34340 |
|                        | SC55100-2B-170 | 170cm | 208.8 | 35280 | 37440 | 37440 | 36360 |
|                        | SC55100-2B-180 | 180cm | 220.4 | 37240 | 39520 | 39520 | 38380 |

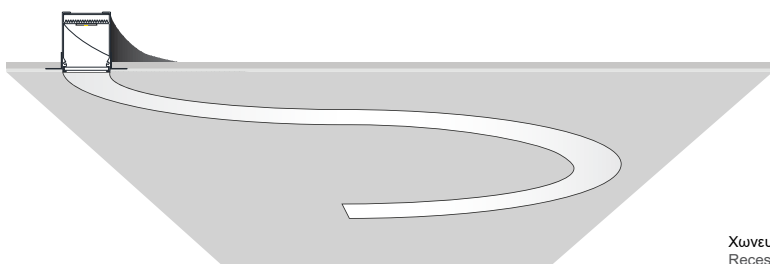

Χωνευτή τοποθέτηση  
Recessed Installation

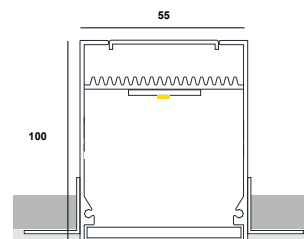

Επίτοιχη τοποθέτηση  
Surface mounted installation

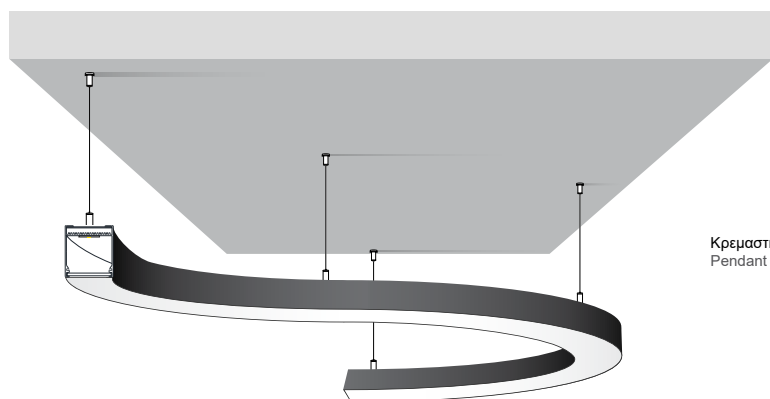
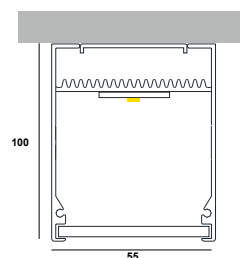

Κρεμαστή τοποθέτηση  
Pendant Installation

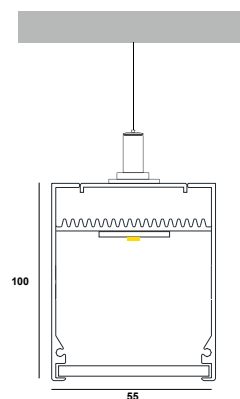

| material           | pcb details                | CRI                      | lumen output / W |
|--------------------|----------------------------|--------------------------|------------------|
| Extruded aluminium | Zhaga-Compliant Dimensions | Ra>80 (Ra>90 on request) | up to 195 Lm/W   |

| covers  | CCT                           | profile color | dimming options (D) |
|---|-------------------------------|---------------|---------------------|
| <br>Diffuser 5mm | 3000K (3)                     | Anodised (AN) | Push                |
|   | 4000K (4)                     | Black (BL)    | DALI                |
|   | 5000K (5)                     | White (WH)    | TRIAC 0/1-10V       |
|   | 6500K (6)                     | RAL (RL)      | CASAMBI             |
|   | TUNABLE<br>2700K - 6500K (TN) |               | Analog 0/1-10V      |



SPECIAL CONSTRUCTIONS

## How to build your custom-made Curves

Στην **BARISLIGHT®** μπορείτε να δημιουργήσετε μοναδικά και μοντέρνα καμπύλα φωτιστικά χώρου, χωνευτά, επίτοιχα ή κρεμαστά. Επιλέξτε ανάμεσα στις διαστάσεις που παρέχουμε, προσαρμόστε τα τεχνικά χαρακτηριστικά σύμφωνα με τις ανάγκες του χώρου σας, και δημιουργήστε μοναδικά σχέδια

At **BARISLIGHT®** you can create unique and modern curved lights, recessed, wall-mounted or suspended. Choose between the dimensions we provide, adapt the technical features according to the needs of your space, and create unique designs

### Ακτίνες κύκλου / Circle Radius

Το καμπύλο προφίλ μας μπορεί να καμφθεί σύμφωνα με τις παρακάτω ακτίνες.  
Our curved profile can be bent according to the following radius

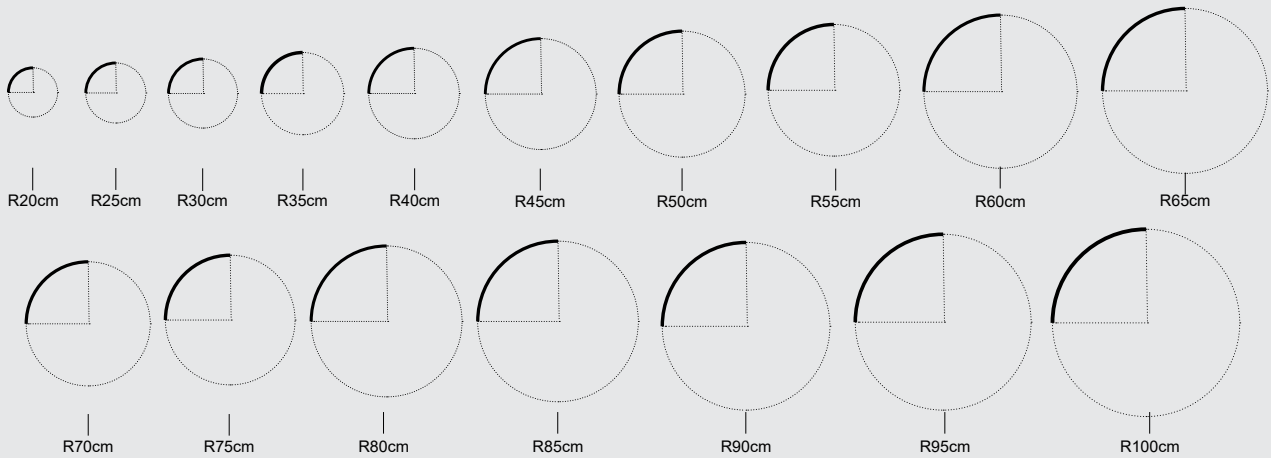

Σε συνεννόηση με την έμπειρη κατασκευαστική μας ομάδα, υπάρχουν αμέτρητες επιλογές για να δημιουργήσετε.  
In consultation with our experienced construction team, there are countless options for you to create.

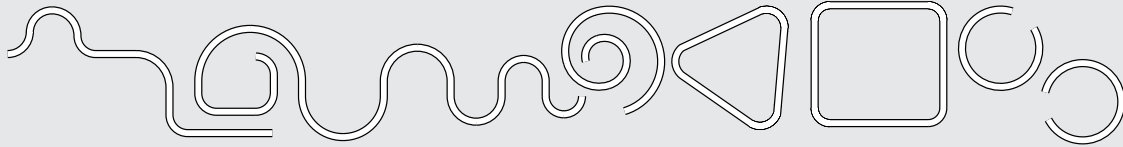

### Χρώμα / Color

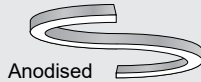
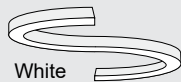
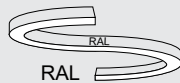

### Κατηγορία απόδοσης lumen / Lumen output class



### Θερμοκρασία φωτός / Kelvin

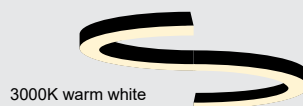



SPECIAL CONSTRUCTIONS



Επικοινωνώντας με την κατασκευαστική ομάδα της BarisLight, μπορείτε να δημιουργήσετε τον ιδανικό Γραμμικό φωτισμό για το χώρο σας, συνδυάζοντας τους αντιθαμβωτικούς φακούς Dark με κάλυμμα διάχυσης, δημιουργώντας εναλλαγές ανάλογα με τον φωτισμό που θέλετε να πετύχετε. Η ομάδα μας είναι έτοιμη να συζητήσει για τις ανάγκες του χώρου σας, και να σας προτείνει την ιδανική λύση.

By contacting the BarisLight manufacturing team, you can create the ideal Linear lighting for your space, combining the Dark anti-glare lenses with a diffusion cover, creating changes depending on the lighting you want to achieve. Our team is ready to discuss the needs of your space, and suggest the ideal solution.



DON 44x51mm  
Dark / Diffuse



LENA 55x35mm  
Dark / Diffuse



NILE RECESSED 55x80mm  
Dark / Diffuse

Τα γραμμικά μας DON 44x51, LENA 55x35 (χωνευτά / επίτοιχα / κρεμαστά), LINEAR 55x70 και NILE recessed 55x80 είναι σχεδιασμένα έτσι ώστε να υποδέχονται τόσο το κάλυμμα διάχυσης, όσο και τους αντιθαμβωτικούς φακούς Dark της BarisLight.

Our linear DON 44x51, LENA 55x35 (recessed / wall mounted / pendant), LINEAR 55x70 and NILE recessed 55x80 are designed to accept both the diffusion cover and the anti-glare Dark lenses of BarisLight







SPECIAL CONSTRUCTIONS

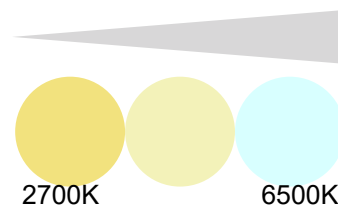

Η BarisLight® σας προσφέρει τη δυνατότητα να προσαρμόσετε το γραμμικό φωτισμό σας σύμφωνα με τις ανάγκες του χώρου σας όσο καλύτερα γίνεται. Με τα νέα μας γραμμικά Tunable 2700K - 6500K, μπορείτε να ελέγχετε απόλυτα το φωτισμό του χώρου σας και να τον προσαρμόζετε στις ανάγκες της εκάστοτε στιγμής. Επιλέγοντας 2700K, δημιουργείτε μια ζεστή ατμόσφαιρα ιδανική για χαλάρωση και φιλοξενία. Αντίθετα, επιλέγοντας 6500K, αναζωογονείτε το χώρο σας με ένα φως παρόμοιο με αυτό της ημέρας, ιδανικό για εργασία ή ανάγνωση.

BarisLight® offers you the possibility to customize your linear lighting according to the needs of your space as best as possible. With our new Linears Tunable 2700K - 6500K, you can have total control over the lighting of your space and adapt it to the needs of the moment. By choosing 2700K, you create a warm atmosphere ideal for relaxation and hospitality. On the other hand, by choosing 6500K, you brighten up your space with a light similar to daylight, ideal for working or reading.

Είτε πρόκειται για τα Dark γραμμικά μας, είτε για τα Diffuse, μπορείτε να επιλέξετε τις κατηγορίες **1A Tunable 2700K-6500K (T1)** ή **1B Tunable 2700K-6500K (T2)** και να ελέγξετε τον φωτισμό σας στο έπακρο.

Whether it's our Dark linear or Diffuse, you can choose **1A Tunable 2700K-6500K (T1)** or **1B Tunable 2700K-6500K (T2)** and control your lighting to the fullest.

|                                   | length | wattage | lumens |       |
|-----------------------------------|--------|---------|--------|-------|
|                                   |        |         | 2700K  | 6500K |
| 1A TUNABLE 2700K-6500K 350mA (T1) | 60cm   | 11.8    | 1990   | 2070  |
|                                   | 90cm   | 17.6    | 2985   | 3105  |
|                                   | 120cm  | 23.5    | 3980   | 4140  |
|                                   | 150cm  | 29.4    | 4975   | 5175  |
|                                   | 180cm  | 35.3    | 5970   | 6210  |
|                                   | 210cm  | 41.2    | 6965   | 7245  |
|                                   | 240cm  | 47.0    | 7960   | 8280  |
|                                   | 270cm  | 52.9    | 8955   | 9315  |
|                                   | 300cm  | 58.8    | 9950   | 10350 |
|                                   | 330cm  | 64.7    | 10945  | 11385 |
|                                   | 360cm  | 70.6    | 11940  | 12420 |
|                                   | 390cm  | 76.4    | 12935  | 13455 |
|                                   | 420cm  | 82.3    | 13930  | 14490 |
|                                   | 450cm  | 88.2    | 14925  | 15525 |
| 480cm                             | 94.1   | 15920   | 16560  |       |

- Color dynamic from 2700K to 6500K
- Long service lifetime: >60000hrs
- Highly efficient: up to 175 Lm/W
- 300mm cutting length
- PUSH BUTTON / DALI

|                                   | length | wattage | lumens |       |
|-----------------------------------|--------|---------|--------|-------|
|                                   |        |         | 2700K  | 6500K |
| 1B TUNABLE 2700K-6500K 500mA (T2) | 60cm   | 17.4    | 2790   | 2890  |
|                                   | 90cm   | 26.0    | 4185   | 4335  |
|                                   | 120cm  | 34.7    | 5580   | 5780  |
|                                   | 150cm  | 43.4    | 6975   | 7225  |
|                                   | 180cm  | 52.1    | 8370   | 8670  |
|                                   | 210cm  | 60.8    | 9765   | 10115 |
|                                   | 240cm  | 69.4    | 11160  | 11560 |
|                                   | 270cm  | 78.1    | 12555  | 13005 |
|                                   | 300cm  | 86.8    | 13950  | 14450 |
|                                   | 330cm  | 95.5    | 15345  | 15895 |
|                                   | 360cm  | 104.2   | 16740  | 17340 |
|                                   | 390cm  | 112.8   | 18135  | 18785 |
|                                   | 420cm  | 121.5   | 19530  | 20230 |
|                                   | 450cm  | 130.2   | 20925  | 21675 |
| 480cm                             | 138.9  | 22320   | 23120  |       |

6500K

4000K

2700K

TUNABLE 2700K - 6500K



Το Blu2Light είναι ένα ασύρματο σύστημα διαχείρισης φωτισμού που βασίζεται στην τεχνολογία Bluetooth®. Επιτρέπει τον βολικό, απλό και ασύρματο έλεγχο του φωτισμού μέσω εφαρμογών με χρήση κινητών συσκευών.

Με αυτόν τον τρόπο, μπορούν να συνδεθούν DALI, DMX, τροφοδοτικά LED, σένσορες και γενικά έλεγχος χώρου. Το σύστημα αυτό, μπορεί να χρησιμοποιηθεί για ένα ευρύ φάσμα εφαρμογών.

Blu2Light is a wireless lighting management system based on Bluetooth® technology. It allows convenient, simple and wireless control of lighting through applications using mobile devices.

In this way, DALI, DMX, LED power supplies, sockets and general room control can be connected. This system can be used for a wide range of applications

# Blu2Light

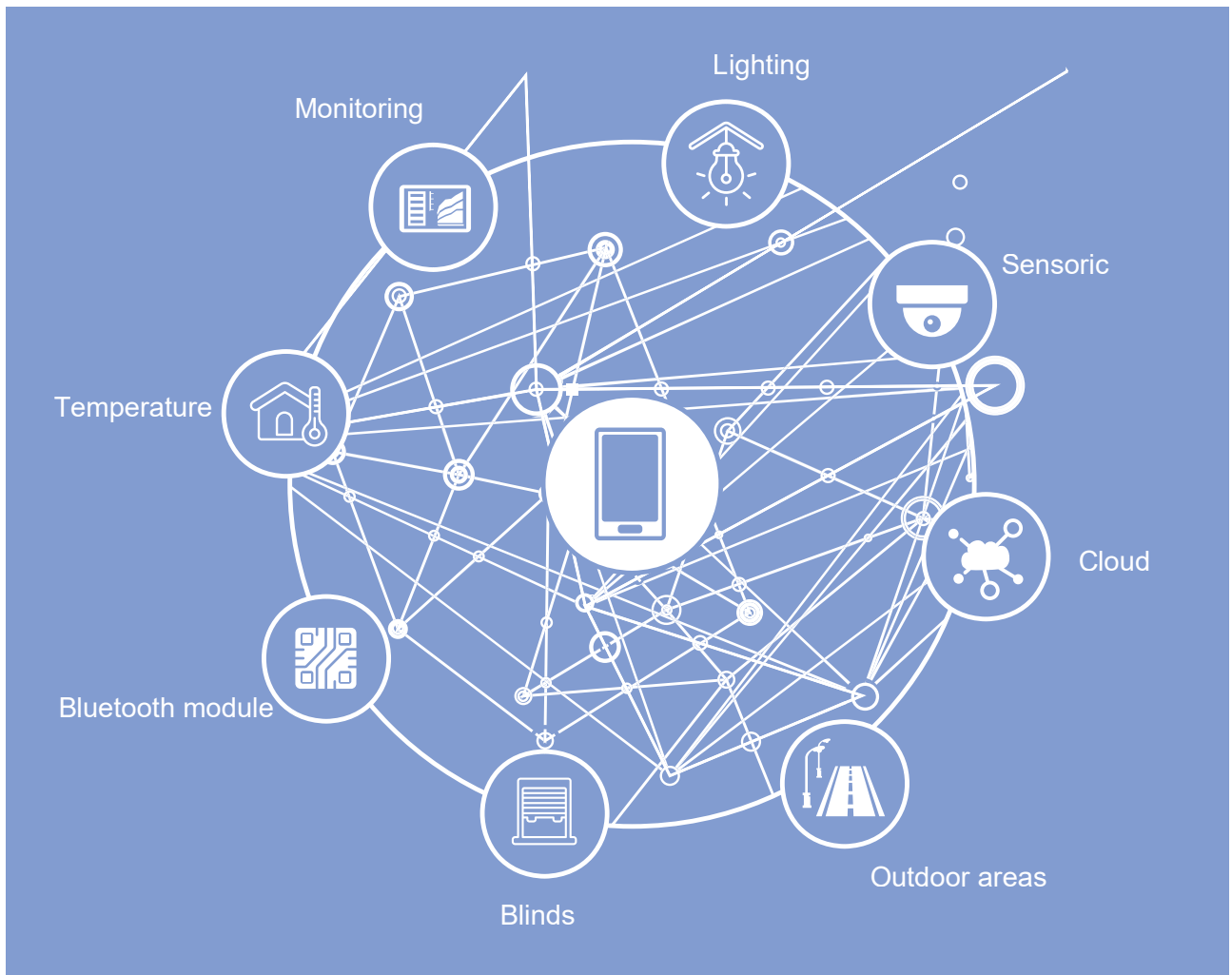
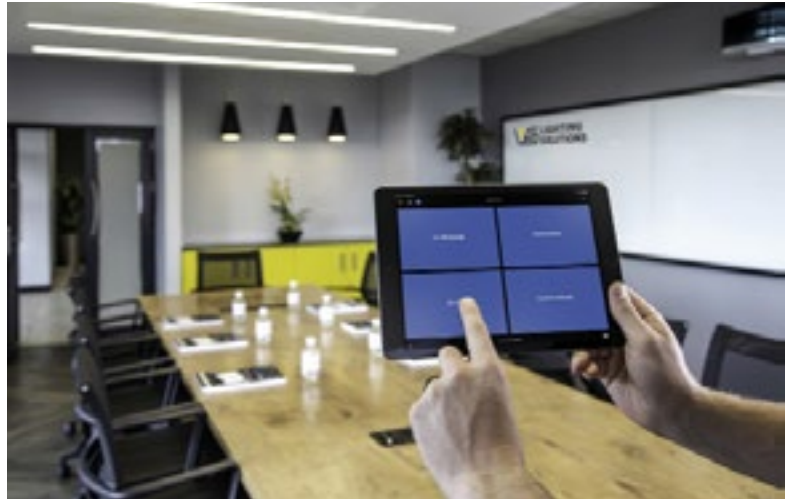



BARISLIGHT



## Όροι εγγύησης

Σε περίπτωση που μια συσκευή παρουσιάσει εντός του συμφωνημένου χρόνου ισχύος της εργοστασιακής εγγύησης της "BARIS LIGHT" σφάλμα υλικού ή κατασκευαστικό ελάττωμα, η συσκευή ή το ελαττωματικό εξάρτημα επισκευάζεται ή αντικαθίσταται από την "BARIS LIGHT" σύμφωνα με την κρίση της. Η "BARIS LIGHT" αναλαμβάνει την πλήρη ή μερική αντικατάσταση των απαραίτητων ανταλλακτικών για την επαναφορά της απρόσκοπτης λειτουργίας. Η "BARIS LIGHT" έχει δικαίωμα να χρησιμοποιεί μεταχειρισμένα, ανακατασκευασμένα ανταλλακτικά. Το εργατικό κόστος ή όποιο άλλο κόστος τρίτου δεν είναι υποχρέωση της "BARIS LIGHT". Η δυσαναλογία κατά την προαναφερόμενη έννοια συνίσταται ιδίως στην περίπτωση που οι απαιτούμενες ενέργειες θα συνεπάγονταν για την "BARIS LIGHT" έξοδα πέραν του ορίου του ανεκτού:

σε σχέση με την τιμή αγοράς ή/και την αξία της συσκευής σε κατάσταση χωρίς ελαττώματα, λαμβάνοντας υπόψη τη σοβαρότητα του ελαττώματος και κατ'εκτίμηση, εάν θα μπορούσαν να εφαρμοστούν εναλλακτικοί τρόποι αποκατάστασης του ελαττώματος χωρίς σημαντικές δυσχέρειες για τον αγοραστή. Επαφίεται ωστόσο στην κρίση της "BARIS LIGHT", να ζητήσει την αποστολή του ελαττωματικού εξαρτήματος για επισκευή ή αντικατάσταση. Η "BARIS LIGHT" έχει μόνο υποχρέωση για αφαίρεση ή τοποθέτηση του εξαρτήματος, εφόσον απαιτούνται ειδικές γνώσεις, τις οποίες δεν κατέχει ή δεν αναμένεται να κατέχει ο αγοραστής, διαφορετικά η υποχρέωση της "BARIS LIGHT" σε σχέση με το ελάττωμα εξαντλείται με την παράδοση του επισκευασμένου ή αντικατεστημένου εξαρτήματος στον αγοραστή.

Στην εργοστασιακή εγγύηση δεν περιλαμβάνονται επιπρόσθετα και τα έξοδα αποστολής, καθώς και ενδεχομένως τα έξοδα μετάβασης και παραμονής του προσωπικού συντήρησης της "BARIS LIGHT" για επιτόπιες επισκευές, κατά την εγκατάσταση συσκευών εντός της Ελλάδας καθώς επίσης και στις παρακάτω χώρες: Αυστρία, Βέλγιο, Βουλγαρία, Γαλλία, Γερμανία, Δημοκρατία της Τσεχίας, Ελβετία, Ελλάδα, Κύπρος, Ηνωμένα Αραβικά Εμιράτα, Ιαπωνία, Ινδία, Ισπανία, Ισραήλ, Ιταλία, Λουξεμβούργο, Μεγάλη Βρετανία, Νότιος Αφρική, Νότιος Κορέα, Ολλανδία, Πορτογαλία, Ταϊλάνδη, Χιλή. Αποκλείονται τελωνειακοί δασμοί, φόροι και λοιπά έξοδα εισαγωγής. Για τη Βόρεια Αμερική ισχύουν ξεχωριστοί όροι εγγύησης.

Αναλώσιμα και εξαρτήματα, που υπόκεινται σε φυσιολογική φθορά, δεν καλύπτονται από την παρούσα εγγύηση (π.χ. Μετασχηματιστές, τροφοδοτικά, πυκνωτές, ασφάλειες, φίλτρα, διατάξεις προστασίας από υπερφόρτιση).

## Έκταση της εργοστασιακής εγγύησης

Προϋπόθεση για την εκτέλεση παροχών εγγύησης χωρίς χρέωση είναι:

Ο αγοραστής οφείλει να γνωστοποιήσει άμεσα στην "BARIS LIGHT" τις διαπιστωμένες ελλείψεις, με μήνυμα με σύντομη περιγραφή του σφάλματος στη γραμμή εξυπηρέτησης "BARIS LIGHT".

Υποβολή ενός αντιγράφου του παραστατικού αγοράς

Η πινακίδα τύπου της συσκευής πρέπει να είναι απόλυτα ευανάγνωστη.

Συνεννόηση για τη διαδικασία με την "BARIS LIGHT" ή τους συνεργάτες σέρβις αυτής.

Για τη διενέργεια των σύμφωνα με την εκτίμηση της "BARIS LIGHT" απαραίτητων επισκευών και παραδόσεων αντικατάστασης, ο πελάτης οφείλει να παράσχει στην "BARIS LIGHT" τον απαιτούμενο χρόνο και την απαιτούμενη ευκαιρία. Τα παλιά, ελαττωματικά εξαρτήματα περιέρχονται στην ιδιοκτησία της "BARIS LIGHT". Η εργοστασιακή εγγύηση δεν καλύπτει ζημιές, που οφείλονται σε:

ζημιές κατά τη μεταφορά

λανθασμένη εγκατάσταση ή θέση σε λειτουργία από τον αγοραστή ή από τρίτους  
επεμβάσεις, τροποποιήσεις ή προσπάθειες επισκευής από τον αγοραστή ή από τρίτους  
παράβλεψη των οδηγιών χρήσης, των προδιαγραφών συντήρησης  
ακατάλληλη χρήση ή αδόκιμη λειτουργία

ανεπαρκή αερισμό της συσκευής (αν κρίνεται απαραίτητο από τις οδηγίες εγκατάστασης του προϊόντος)

ατυχήματα, εξωτερική επίδραση

ανωτέρα βία (π.χ. πτώση κεραυνού, υπέρταση, κακοκαιρία, πυρκαγιά)

Επίσης, δεν καλύπτει ελαττώματα αισθητικού χαρακτήρα ή σημάδια φθοράς, τα οποία δεν επηρεάζουν την τροφοδοσία ενέργειας. Εάν ο αγοραστής απαιτήσει με αυτή την εγγύηση μη απαραίτητες ή αναίτιες επεμβάσεις του σέρβις, η "BARIS LIGHT" έχει δικαίωμα να τον χρεώσει με τα έξοδα που θα προκύψουν. Το ίδιο ισχύει για χρόνους αναμονής, εάν ο αγοραστής δεν παράσχει στο προσωπικό συντήρησης άμεση πρόσβαση στην ελαττωματική συσκευή. Εφόσον δεν προβλέπεται ρητά από το νόμο ευθύνη της "BARIS LIGHT", η εργοστασιακή εγγύηση δεν περιλαμβάνει υποχρεώσεις πέραν των αναφερόμενων στους όρους της εγγύησης, ιδίως δε σε ότι αφορά την κάλυψη ζημιών που προέκυψαν άμεσα ή έμμεσα.

## Terms of Warranty

In the event that a device presents a material or manufacturing defect within the agreed warranty period of "BARIS LIGHT", the appliance or defective component is repaired or replaced by "BARIS LIGHT" at its discretion. "BARIS LIGHT" undertakes the replacement or replacement of the spare parts necessary to restore uninterrupted operation. "BARIS LIGHT" has the right to use used, remanufactured spare parts. The labor costs or any other cost of a third party is not an obligation of "BARIS LIGHT". The imbalance in the above-mentioned concept consists in particular in the event that the required actions would entail costs beyond the tolerable limit for "BARIS LIGHT":

in relation to the purchase price and / or the value of the appliance in a non-defective condition, taking into account the seriousness of the defect and, if so, whether alternative ways of remedying the defect could be applied without significant difficulties for the purchaser.

However, it is up to BARIS LIGHT to ask for the defective part to be repaired or replaced. "BARIS LIGHT" has only the obligation to remove or place the accessory if special knowledge is required which the purchaser does not own or are not expected to own, otherwise the obligation of "BARIS LIGHT" in relation to the defect is depleted by delivering the repaired or replaced component to the buyer.

The factory warranty does not include additionally shipping costs and, where applicable, the cost of travel and subsistence of BARIS LIGHT maintenance personnel for on-site repairs when installing appliances within Greece as well as in the following countries: Austria, Belgium, Bulgaria, France, Germany, Czech Republic, Switzerland, Greece, Cyprus, United Arab Emirates, Japan, India, Spain, Israel, Italy, Luxemburg, Great Britain, South Africa, South Korea, Netherlands, Portugal, Thailand, Chile or. Customs duties, taxes and other import charges are excluded. For North America, separate warranty terms apply.

Consumables and accessories subject to normal wear and tear are not covered by this warranty (eg Transformers, power supplies, capacitors, fuses, filters, overload protection devices).

## Scope of the factory warranty

The condition for the performance of free-of-charge warranty services is:

The buyer must immediately notify BARIS LIGHT of the deficiencies found, with a short description of the error in the service bar "BARIS LIGHT".

Submission of a copy of the purchase receipt

The type plate of the device must be perfectly legible.

Consultation on the procedure with "BARIS LIGHT" or its service partners.

In order to carry out the necessary repairs and replacement deliveries according to the "BARIS LIGHT" estimate, the customer must provide "BARIS LIGHT" with the required time and the required opportunity. The old, defective parts come to the property of "BARIS LIGHT". The factory warranty does not cover damages due to:

damage during transport

incorrect installation or commissioning by the buyer or by third parties

interventions, modifications, or repair efforts by the buyer or by third parties

ignoring instructions for use, maintenance specifications

inappropriate use or inadequate operation

insufficient ventilation of the appliance (if necessary as per the installation instructions for the product)

accidents, external impact

Force majeure (eg lightning strike, hypertension, bad weather, fire)

It also does not cover aesthetic defects or signs of wear, which do not affect the supply energy. If the buyer demands with this guarantee unnecessary or unnecessary service interventions, BARIS LIGHT is entitled to charge it with the costs incurred. The same applies for waiting times if the buyer does not provide maintenance personnel with direct access to the faulty device. As long as the liability of BARIS LIGHT is not expressly provided for by law, the factory warranty does not include obligations other than those specified in the terms of the guarantee, in particular as regards the coverage of losses incurred directly or indirectly.





Το προϊόν έχει ελεγχθεί και θεωρείται ότι πληροί τις ευρωπαϊκές προδιαγραφές ως προς την ασφάλεια και την προστασία της υγείας και του περιβάλλοντος.  
The product has been tested and is considered to meet European standards for safety, health and environmental protection.



Περιορισμός επικίνδυνων ουσιών: Το προϊόν συμμορφώνεται με την οδηγία rOhs και κάθε ομοιογενές υλικό δεν υπερβαίνει τα όρια για τα υλικά που αναφέρονται στην οδηγία RoHS (Pb, Hg, Cd, Cr6+, PBB και PBDE)  
Restriction of Hazardous Substances (RoHS): PRODUCT COMPLIES WITH rOhs directive and each homogenous material does not exceed the limits for materials mentioned under the RoHS directive (Pb, Hg, Cd, Cr6+, PBB and PBDE)



Το προϊόν διαθέτει εγγύηση χρόνων ίση με την αναγραφόμενη τιμή  
The product is guaranteed for a period of time equal to the number indicated.



Τύπος προστασίας: Μονός  
Safety class: One



Τύπος προστασίας: Διπλός  
Safety class: Two



Τύπος προστασίας: Τριπλός  
Safety class: Three



Η διάρκεια ζωής του προϊόντος ισούται με τον αριθμό ωρών που αναγράφονται.  
The lifetime of the product is equal to the number of hours indicated.



Προστασία από εισχώρηση σωμάτων Ø2.5mm  
Protection from ingress of Ø2.5mm elements



Προστασία από εισχώρηση σωμάτων Ø1mm  
Protection from ingress of Ø1mm elements



Προστασία από δυσλειτουργίες λόγω σκόνης και έκθεσης του υλικού στο νερό  
Protection from malfunctions due to dust and water



Πλήρης προστασία από σκόνη και έκθεσης του υλικού στο νερό  
Full protection from dust and exposure to water



Πλήρης προστασία από σκόνη και έκθεσης του υλικού στο νερό υψηλής πίεσης (Jet 12,5 l / min σε απόσταση 2,5 μέτρων από οποιαδήποτε κατεύθυνση)  
Full protection from dust and high pressure water (Jet of 12.5 l/min at a distance of 2.5 metres from any direction)



Πλήρης προστασία από σκόνη και έκθεσης του υλικού στο νερό υψηλής πίεσης (Jet 100l / min σε απόσταση 2,5 μέτρων από οποιαδήποτε κατεύθυνση)  
Full protection from dust and high pressure water (Powerful jets of 100 l/min at a distance of 2.5 metres from any direction)



Πλήρης προστασία από σκόνη και από ασυνεχή βύθιση στο νερό  
Full protection from dust and intermittent submersion in water



Πλήρης προστασία από σκόνη και από συνεχή βύθιση σε νερό σταθερής πίεσης  
Full protection from dust and against constant immersion in water under certain pressure



Το προϊόν προστατεύεται από πρόσκρουση 1 joule  
Product is protected against 1 joule of impact



Το προϊόν προστατεύεται από πρόσκρουση 2 joules  
Product is protected against 2 joules of impact



Το προϊόν προστατεύεται από πρόσκρουση 5 joules  
Product is protected against 5 joules of impact



Το προϊόν προστατεύεται από πρόσκρουση 10 joules  
Product is protected against 10 joules of impact



Το προϊόν προστατεύεται από πρόσκρουση 20 joules  
Product is protected against 20 joules of impact



Το προϊόν είναι ανθεκτικό στην υπεριώδη ακτινοβολία (UV) ή στο ηλιακό φως. Τα προϊόντα που δεν αντέχουν στην υπεριώδη ακτινοβολία μπορούν να υποβαθμιστούν ή να αποχρωματιστούν γρήγορα όταν εκτίθενται σε ακτινοβολία UV  
Product is resistant against ultraviolet (UV) light or sunlight. Non-UV resistant products can degrade or discolor fast when exposed UV light.



Το προϊόν έχει δοκιμαστεί για εφαρμογές walkover  
The product has been tested for walkover applications



Διαστάσεις τετράγωνης οπής (σε mm)  
Dimensions of square fitting opening (mm)



Διαστάσεις στρογγυλής οπής (σε mm)  
Dimensions of round fitting opening (mm)



Το προϊόν προορίζεται για εσωτερικό χώρο  
The product is intended for indoor use



Το προϊόν προορίζεται για εξωτερικό χώρο  
The product is intended for outdoor use



Το προϊόν προορίζεται για εσωτερικό και εξωτερικό χώρο  
The product is intended for both indoor and outdoor use



Το προϊόν προορίζεται για υποβρύχια τοποθέτηση  
The product is intended for underwater application



Επιφάνεια τοποθέτησης προϊόντος: Οροφή  
Product's installation surface: Ceiling



Επιφάνεια τοποθέτησης προϊόντος: Έδαφος  
Product's installation surface: Ground



Επιφάνεια τοποθέτησης προϊόντος: Τοίχος  
Product's installation surface: Wall



Σταθερή τάση 12/24 volt  
Constant Voltage 12/24 Volt



Σταθερή τάση 230VAC  
Constant Voltage 230VAC



Το προϊόν διαθέτει την δυνατότητα αυξομειώσης της φωτεινότητας  
The product is dimmable.



Η γωνία δέσμης του προϊόντος ισούται με την αναγραφόμενη τιμή  
The beam angle of the product is equal to the indicated value



Το προϊόν εκπέμπει διάχυτο φως.  
The product emits diffuse light.



Η γωνία δέσμης του προϊόντος είναι 360°  
The beam angle of the product is 360°



Το προϊόν διαθέτει δυνατότητα περιστροφής ως προς τον οριζόντιο άξονα  
The product can be rotated on the horizontal axis



Το προϊόν διαθέτει δυνατότητα περιστροφής ως προς τον κάθετο άξονα  
The product can be rotated on the vertical axis



Το προϊόν διαθέτει δυνατότητα περιστροφής ως προς τον οριζόντιο και κάθετο άξονα  
The product can be rotated on both horizontal and vertical axis



Ο φακός του Downlight μπορεί να περιστραφεί σύμφωνα με τις αναγραφόμενες μοίρες  
The lens of the Downlight can be rotated according to the indicated degrees



Το προϊόν υποδέχεται λαμπτήρα τύπου GU10  
The product accepts GU10 type bulb



Η κάμψη της λωρίδας LED είναι δυνατή με ακτίνα  $\geq x$  χιλιοστόμετρα στην καθορισμένη κατεύθυνση  
Bending of the Led strip is possible with a radius of  $\geq x$  millimetres in the specified direction



Η ταινία LED διατίθεται σε καρούλι με μήκος όσο η αναγραφόμενη τιμή  
The LED strip is available on a reel with a length equal to the indicated price



Η ταινία LED κάμπτεται Πλάγια  
The LED strip is bent Sideways



Η ταινία LED κάμπτεται Κατακόρυφα  
The LED strip bends Vertically



Η ταινία LED κάμπτεται προς όλες τις κατευθύνσεις  
The LED strip bends in all directions



Η απόδοση Lumen / W του προϊόντος ισούται με την αναγραφόμενη τιμή  
The Lumen/W output of the product is equal to the indicated value



Η τιμή CRI του προϊόντος ισούται με την αναγραφόμενη τιμή  
The CRI rate of the product is equal to the indicated value



Θερμό Λευκό  
Warm White



Φυσικό Λευκό  
Natural White



Ψυχρό Λευκό  
Cold White



Ρυθμιζόμενη θερμοκρασία φωτός από Θερμό Λευκό σε Ψυχρό Λευκό  
Tunable light temperature from Warm White to Cool White



Κόκκινο  
Red



Πράσινο  
Green



Μπλε  
Blue



Πορτοκαλί  
Amber



RGB



RGBWW



RGBCW



[barislight.eu](http://barislight.eu)



[b2b.barislight.eu](http://b2b.barislight.eu)



**Έκθεση:**  
Ελ. Βενιζέλου και Βύρωνος,  
26333 Πάτρα

**Βιοτεχνία:**  
Γλαύκου 83, 26332 Πάτρα



2610 317 313  
2610 317 300



[info@barislight.eu](mailto:info@barislight.eu)



[barislight.eu](http://barislight.eu)  
[b2b.barislight.eu](http://b2b.barislight.eu)



Baris Light