

TITE R40 PVC

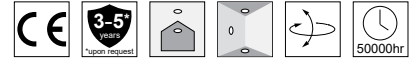

ΠΕΡΙΕΧΟΜΕΝΑ / CONTENTS

DATASHEET	1
General information	1
Options	2
Light distribution	3
MANUAL	4
Application on the surface	4
Connection to the electrical supply	5
Alternative application methods	6
Accessories	7

SKU: TITER40PVC- XX-XX-XX-XX-XX-XX-XX-XX-XX-XX-XX

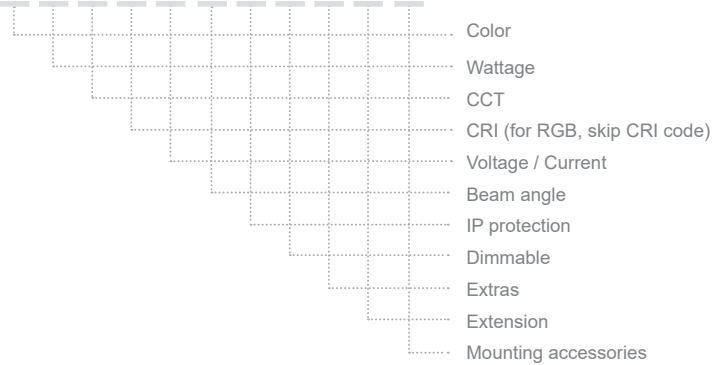

DATASHEET

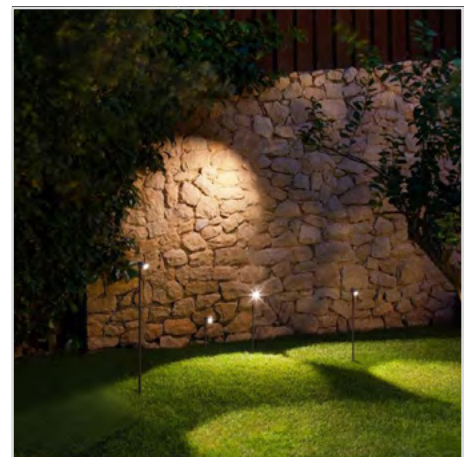
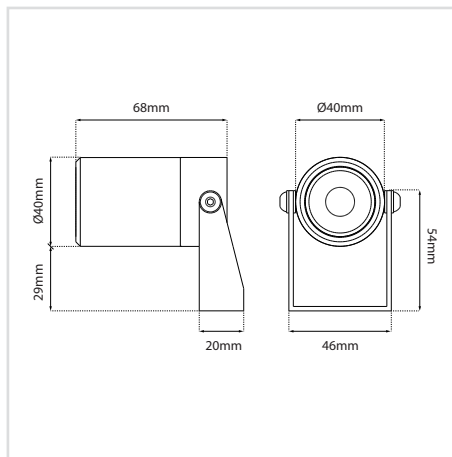

















GENERAL INFORMATION









APPLICATION	Outdoor / Surface mounted
DIRECTION OF MOUNTING	Ceiling / Wall / Ground
MATERIAL	PVC / Inox bracket
COLOR	Dark gray
VISIBLE DIMENSIONS (Ø×L)	Ø40 × 68 mm
INCL. CABLE	Yes
LED TYPE	XTE/XRE/XPE/NICHIA/GU10
LIFE TIME	50000 hours
WARRANTY	3–5 years (*5 years upon request)
ORIGIN	Greece

TITE R40 PVC DATASHEET

SKU: TITER40PVC- XX-XX-XX-XX-XX-XX-XX-XX-XX-XX

COLOR
WATTAGE
CCT
CRI (skip for RGB)
VOLTAGE / CURRENT
BEAM ANGLE
IP PROTECTION
DIMMABLE
EXTRAS
EXTENSION
MOUNTING ACCESSORIES

Color	Wattage*	CCT*	CRI*	Voltage / Current*	Beam Angle*
None (gray) (L) 	0.5W (05W)	2700K (27K) 	Ra80 (80)	12VDC (V1)	Diffuse (DF) 
Patina (PT) 	1W (1W)	3000K (30K) 	Ra90 (90)	24VDC (V2)	8D (8D) 
	2W (2W)	4000K (40K) 		230VAC (V3)	15D (15D) 
	2.5W (25W)	5000K (50K) 		12/24V (V4)	20D (20D) 
	3W (3W)	6000K (60K) 		350mA (V5)	35D (35D) 
	(R) / (G) / (B) / (A) 	RGB (C1) 		500mA (V6)	40D (40D) 
					60D (60D) 
					80D (80D) 

IP*	Dimmable*	Extras	Extension	Extras
IP65 (65)	Yes (D)	Shadow (SH) 	Branch of height 130mm (H13)	Pole Φ10×200mm Brass (PL1) 
IP66 (66)	No (L)	Honeycomb (HC) 	Branch of height 300mm (H30)	Pole Φ10×600mm Brass (PL2) 
IP67 (67)			Branch of height 400mm (H40)	Pole Φ10×1000mm Brass (PL3) 
			Branch of height 500mm (H50)	Spike D32x150mm Aluminium (SP) 
			Branch of height 600mm (H60)	Pole Φ10x200mm Brass with base (PL4) 
			Branch of height 700mm (H70)	Strap-mount for tree branch (TU) 
			Branch of height 800mm (H80)	
			Branch of height 900mm (H90)	
			Branch of height 1000mm (H100)	

* Υποχρεωτική επιλογή / Mandatory option

Δημιουργία Κωδικού προϊόντος / Product Code generator

TITER40PVC- color - wattage - CCT - CRI - voltage - beam angle - IP - dimmable - extras - extension - mounting accessories

EXAMPLE:

TITER40PVC - PT-3W-27K-90-V1-15D-65-D-SH-HC -H30-MB1

for TITE R40 PVC, patina, 3W, 2700K, Ra90, 12VDC, 15°, IP65, dimmable, shadow and honeycomb - branch of height 300mm, base R40x27)

TITE R40 PVC DATASHEET

LIGHT DISTRIBUTION

8D

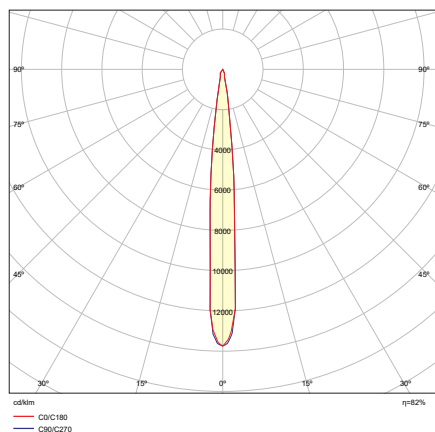

15D

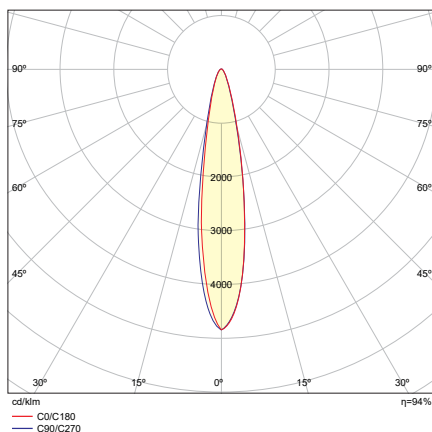

20D

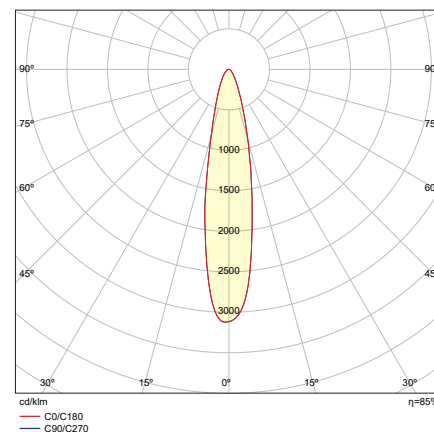

35D

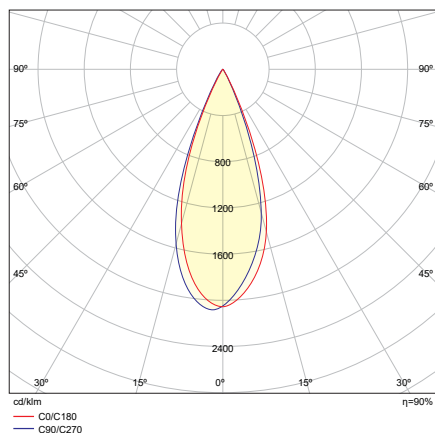

40D

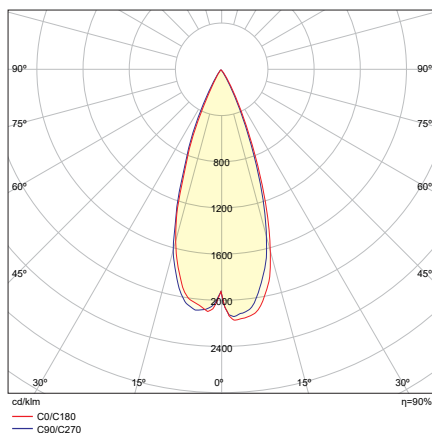

60D

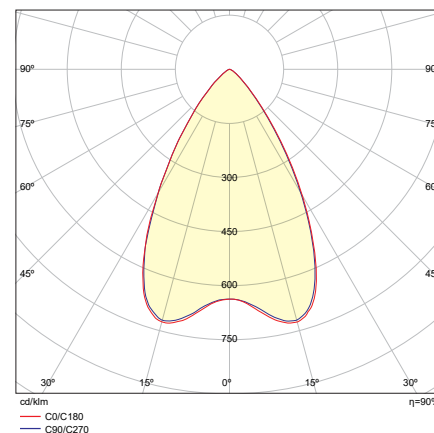

80D

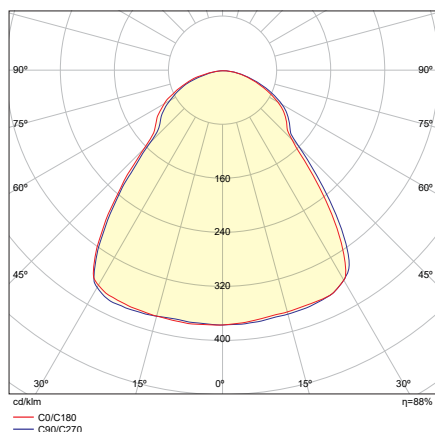

DIFFUSED

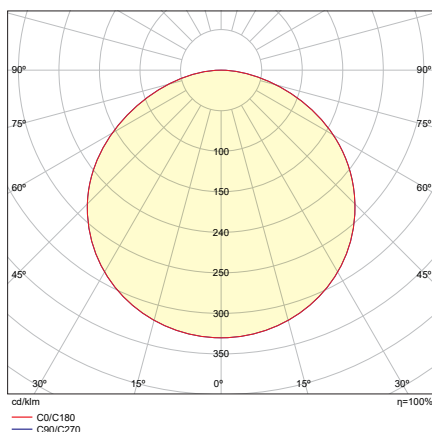

TITE R40 PVC MANUAL

ΟΔΗΓΙΕΣ ΕΓΚΑΤΑΣΤΑΣΗΣ INSTALLATION INSTRUCTIONS

ΣΗΜΑΝΤΙΚΟ:

Αυτό το εξάρτημα πρέπει να εγκατασταθεί από εξειδικευμένο ηλεκτρολόγο.

Η BarisLight δεν φέρει ευθύνη για τυχόν ζητήματα που προκύπτουν από ακατάλληλη εγκατάσταση που δεν συμμορφώνεται με τα τοπικά πρότυπα ασφαλείας.

Παρακαλούμε δώστε ένα αντίγραφο αυτών των οδηγιών στο άτομο που είναι υπεύθυνο για τη συντήρηση της εγκατάστασης.

IMPORTANT:

This luminaire must be installed by a qualified electrician.

Disclaimer:

BarisLight is not liable for any issues arising from improper installation that does not comply with local safety standards.

Instructions:

Please provide a copy of these instructions to the person responsible for maintaining the installation.

Εφαρμογή στην επιφάνεια Application on the surface

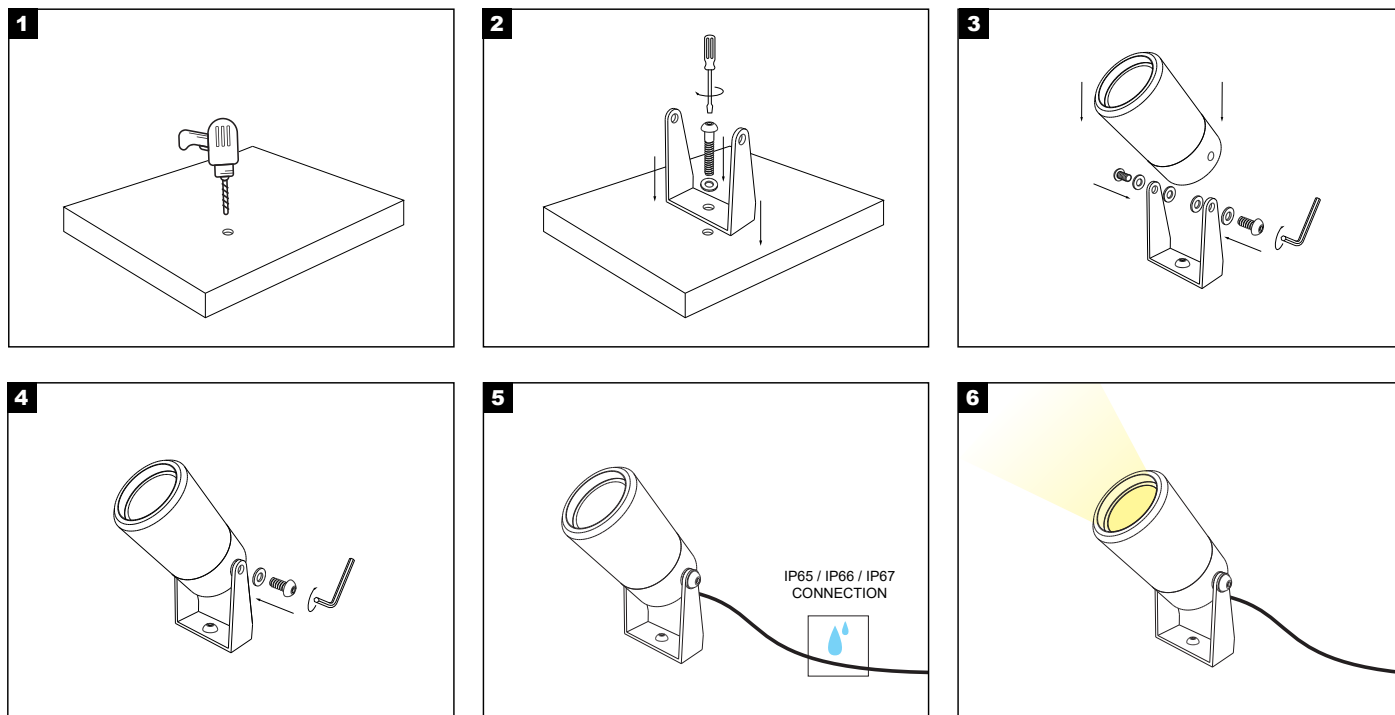

TITE R40 MANUAL

Σύνδεση με την ηλεκτρική παροχή Connection to the electrical supply

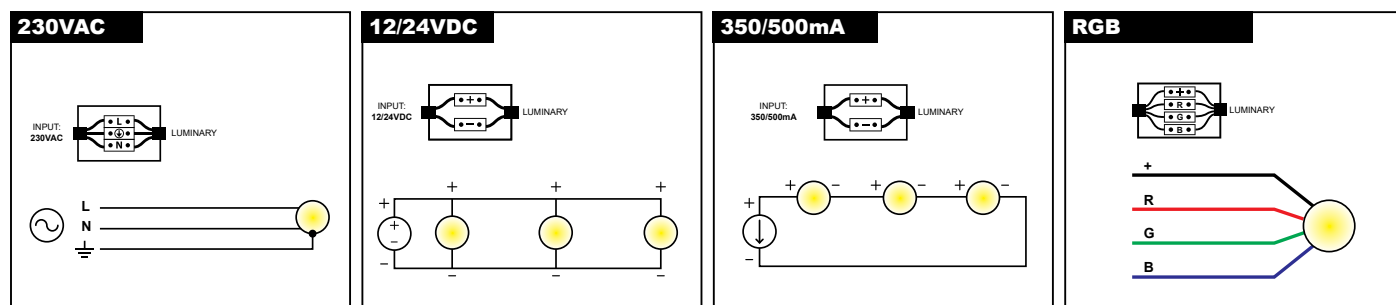

Διαδικασία καλωδίωσης

1. Κλείστε τον κεντρικό διακόπτη ρεύματος.
2. Συνδέστε τα φωτιστικά στη μονάδα παροχής ρεύματος.
3. Συνδέστε τη μονάδα τροφοδοσίας στο ηλεκτρικό δίκτυο.
4. Ενεργοποιήστε τον κεντρικό διακόπτη ρεύματος.

Σημείωση ασφαλείας: Βεβαιωθείτε ότι ο κεντρικός διακόπτης λειτουργίας είναι απενεργοποιημένος κατά τη διάρκεια όλων των διαδικασιών συντήρησης και εγκατάστασης.

Προειδοποίηση: Αποφύγετε τη σύνδεση πάρα πολλών φωτιστικών παράλληλα σε μία μόνο μονάδα τροφοδοσίας για να αποφευχθεί η υπερφόρτωση.

Wiring Procedure

1. Turn off the main power switch.
2. Connect the luminaires to the power supply unit.
3. Connect the power supply unit to the electrical network.
4. Turn on the main power switch.

Safety Notice: Ensure the main power switch is turned off during all maintenance and installation procedures.

Warning: Avoid connecting too many luminaires in parallel to a single power supply unit to prevent overloading.

TITE R40 MANUAL

Εναλλακτικοί τρόποι τοποθέτησης Alternative application methods

Spike D32x150mm Aluminium (SP)

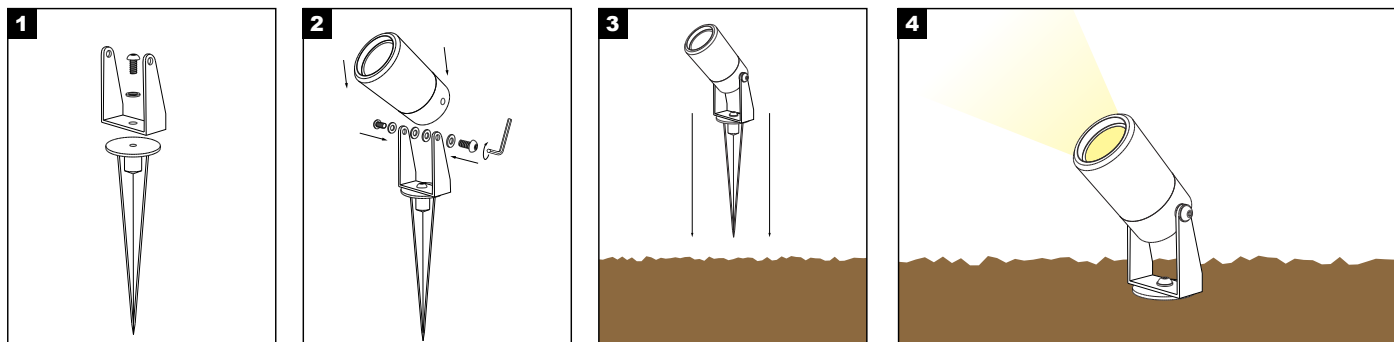

Pole D10x200-1000mm Brass (PL1/ PL2/ PL3)

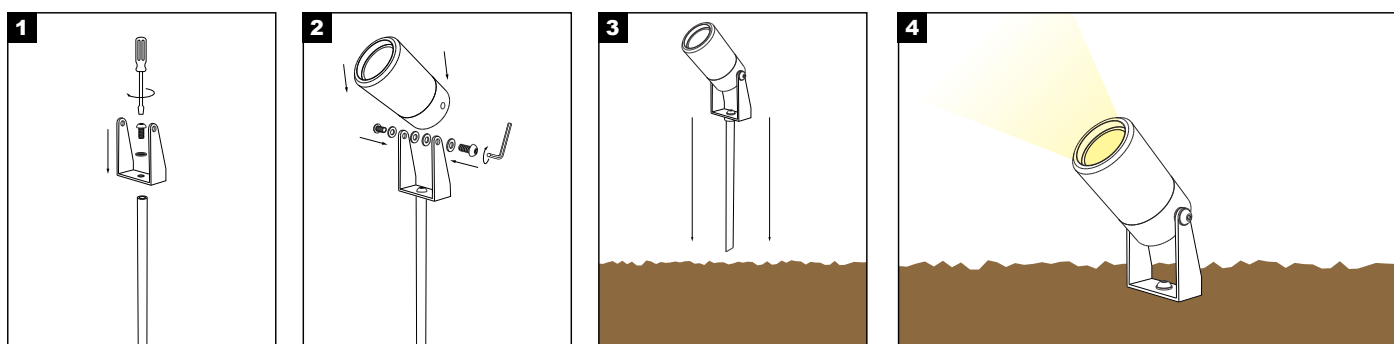

Pole D10x200mm Brass with base (PL4)

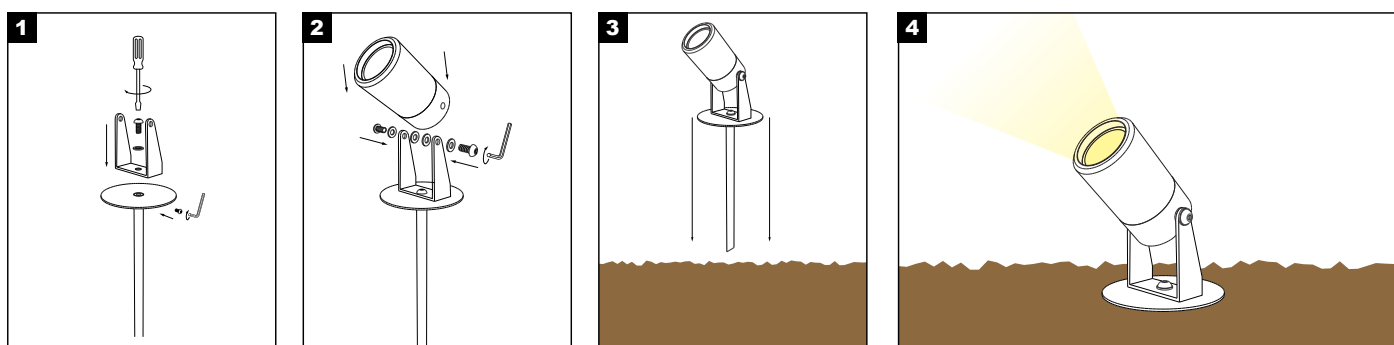

TITE R40 MANUAL

Αξεσουάρ Accessories

Shadow (SH)

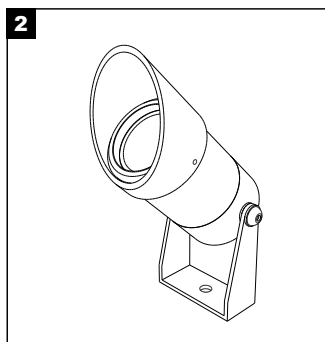
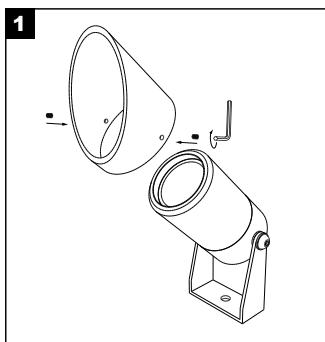

Honeycomb (HC)

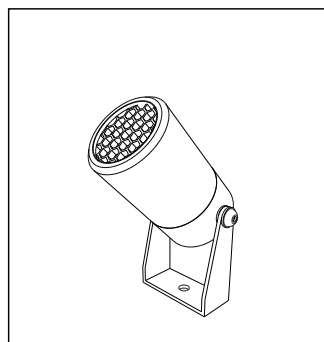

Honeycomb + Shadow (HC-SH)

