



CATALOG 2024

LINEAR LIGHTING SYSTEMS

ΓΡΑΜΜΙΚΑ ΣΥΣΤΗΜΑΤΑ



light. our passion is



**Έκθεση:** Ελ. Βενιζέλου και Βύρωνος, 26333 Πάτρα  
**Βιοτεχνία:** Γλαύκου 83, 26332 Πάτρα



2610 317 313  
2610 317 300



barislight.eu  
b2b.barislight.eu



info@barislight.eu



Baris Light

# Linear lighting systems

ΠΕΡΙΕΧΟΜΕΝΑ / CONTENTS

## χωνευτά / recessed

Linear 30×15mm trimless



Gila 35×35 trimless



Lena 55×35 trimless



Dark Lena 55×35 trimless



Nile 55×80 recessed



Dark Nile 55×80 recessed



## επίτοιχα / surface mounted

Gila 35×35



Lena 55×35



Dark Lena 55×35



Ganges 55×60



Linear 55×70



Dark Linear 55×70



Nile 55×80



## κρεμαστά / suspended

Gila 35×35 suspended



Lena 55×35 suspended



Dark Lena 55×35 suspended



Ganges 55×60 suspended



Linear 55×70  
suspended



pg. 68

Dark Linear 55×70  
suspended



pg. 71

Nile 55×80  
suspended



pg. 74

## Updown

Linear updown 55×70

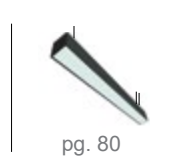

pg. 80

Dark Linear updown 55×70



pg. 84

## κύκλοι / circles

Circle 55×100  
trimless



pg. 90

Circle 55×100



pg. 94

Circle 55×100  
suspended



pg. 98

## Ειδικές κατασκευές / Special constructions

Καμπύλες / Curves

pg. 102

Συνδυασμός Diffuse - Dark / Diffuse - Dark combination

pg. 106

Πλακέτες Tunable 2700K-6500K / Tunable 2700K-6500K modules

pg. 108

**Blu2Light®** wireless light management system

pg. 110

Εγγύηση / Warranty

pg. 112

Σήμανση καταλόγου / Catalogue indication

pg. 114



XΩNEYTA / RECESSED

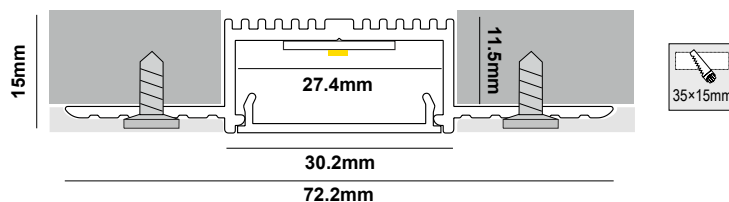

T3015 - XX - XXX - X - X

- (a)  
Κωδικός Γραμμικού  
Linear Code
- (b)  
Κατηγορία  
Category
- (c)  
Μήκος  
Length
- (d)  
CCT
- (f)  
Αυξομείωση  
έντασης φωτός  
Dimming

Παράδειγμα κωδικού / Code example

LINEAR 30×15 TRIMLESS 1A 85cm 3000K Dimmable  
SKU: T3015-1A-85-3-D

material	pcb details	CRI	lumen output / W
Extruded aluminium	Zhaga-Compliant Dimensions	Ra>80 (Ra>90 on request)	up to 195 Lm/W

covers	CCT	dimming options (D)
<p>Click diffuser 1.5mm ( up to 70m reel )</p>	3000K (3)	Push
	4000K (4)	DALI
	5000K (5)	TRIAC 0/1-10V
	6500K (6)	CASAMBI
	TUNABLE 2700K - 6500K (TN)	Analog 0/1-10V



RECESSED TRIMLESS

## LINEAR 30×15 TRIMLESS / Lumen output tables

CATEGORY 1A 350mA (1A)	code	length	watt	lumens 3000K	lumens 4000K	lumens 5000K	lumens 6500K
	T3015-1A-57	57cm	7.8	1390	1470	1470	1440
	T3015-1A-85	85cm	11.7	2085	2205	2205	2160
	T3015-1A-113	113cm	15.6	2780	2940	2940	2880
	T3015-1A-141	141cm	19.5	3475	3675	3675	3600
	T3015-1A-169	57cm	23.4	4170	4410	4410	4320
	T3015-1A-197	85cm	27.3	4865	5145	5145	5040
	T3015-1A-225	113cm	31.2	5560	5880	5880	5760
	T3015-1A-253	141cm	35.1	6255	6615	6615	6480
	T3015-1A-281	281cm	39	6950	7350	7350	7200
	T3015-1A-309	309cm	42.9	7645	8085	8085	7920
	T3015-1A-337	337cm	46.8	8340	8820	8820	8640
	T3015-1A-365	365cm	50.7	9035	9555	9555	9360
	T3015-1A-393	393cm	54.6	9730	10290	10290	10080
	T3015-1A-421	421cm	58.5	10425	11025	11025	10800
T3015-1A-449	449cm	62.4	11120	11760	11760	11520	

wattage: 13.5 W/m

CATEGORY 1B 500mA (1B)	T3015-1B-57	57cm	11.6	1960	2070	2070	2020
	T3015-1B-85	85cm	17.4	2940	3105	3105	3030
	T3015-1B-113	113cm	23.2	3920	4140	4140	4040
	T3015-1B-141	141cm	29	4900	5175	5175	5050
	T3015-1B-169	169cm	34.8	5880	6210	6210	6060
	T3015-1B-197	197cm	40.6	6860	7245	7245	7070
	T3015-1B-225	225cm	46.4	7840	8280	8280	8080
	T3015-1B-253	253cm	52.2	8820	9315	9315	9090
	T3015-1B-281	281cm	58	9800	10350	10350	10100
	T3015-1B-309	309cm	63.8	10780	11385	11385	11110
	T3015-1B-337	337cm	69.6	11760	12420	12420	12120
	T3015-1B-365	365cm	75.4	12740	13455	13455	13130
	T3015-1B-393	393cm	81.2	13720	14490	14490	14140
	T3015-1B-421	421cm	87	14700	15525	15525	15150
	T3015-1B-449	449cm	92.8	15680	16560	16560	16160

wattage: 20 W/m

Το φωτιστικό είναι διαθέσιμο σε μήκος πολλαπλάσιο των 14 εκατοστών

The illuminant is available in lengths that are multiples of 14 centimeters.



## LINEAR 30×15 TRIMLESS / Lumen output tables

CATEGORY 2A 350mA (2A)	code	length	watt	lumens 3000K	lumens 4000K	lumens 5000K	lumens 6500K
	T3015-2A-57	57cm	23.6	4080	4380	4380	4080
	T3015-2A-85	85cm	35.4	6120	6570	6570	6120
	T3015-2A-113	113cm	47.2	8160	8760	8760	8160
	T3015-2A-141	141cm	59	10200	10950	10950	10200
	T3015-2A-169	169cm	70.8	12240	13140	13140	12240
	T3015-2A-197	197cm	82.6	14280	15330	15330	14280
	T3015-2A-225	225cm	94.4	16320	17520	17520	16320
	T3015-2A-253	253cm	106.2	18360	19710	19710	18360
	T3015-2A-281	281cm	118	20400	21900	21900	20400
	T3015-2A-309	309cm	129.8	22440	24090	24090	22440
	T3015-2A-337	337cm	141.6	24480	26280	26280	24480
	T3015-2A-365	365cm	153.4	26520	28470	28470	26520
	T3015-2A-393	393cm	165.2	28560	30660	30660	28560
	T3015-2A-421	421cm	177	30600	32850	32850	30600
T3015-2A-449	449cm	188.8	32640	35040	35040	32640	

wattage: 40.5 W/m

T3015-2B-57	57cm	35	5700	6140	6140	5700
T3015-2B-85	85cm	52.5	8550	9210	9210	8550
T3015-2B-113	113cm	70	11400	12280	12280	11400
T3015-2B-141	141cm	87.5	14250	15350	15350	14250
T3015-2B-169	169cm	105	17100	18420	18420	17100
T3015-2B-197	197cm	122.5	19950	21490	21490	19950
T3015-2B-225	225cm	140	22800	24560	24560	22800
T3015-2B-253	253cm	157.5	25650	27630	27630	25650
T3015-2B-281	281cm	175	28500	30700	30700	28500
T3015-2B-309	309cm	192.5	31350	33770	33770	31350
T3015-2B-337	337cm	210	34200	36840	36840	34200
T3015-2B-365	365cm	227.5	37050	39910	39910	37050
T3015-2B-393	393cm	245	39900	42980	42980	39900
T3015-2B-421	421cm	262.5	42750	46050	46050	42750
T3015-2B-449	449cm	280	45600	49120	49120	45600

wattage: 60.5 W/m

Το φωτιστικό είναι διαθέσιμο σε μήκος πολλαπλάσιο των 14 εκατοστών

The illuminant is available in lengths that are multiples of 14 centimeters.



**(-M-)**  
 χωνευτή τοποθέτηση με  
 γωνιόκρανο αλουμινίου  
 Trimless Installation with  
 aluminium angular

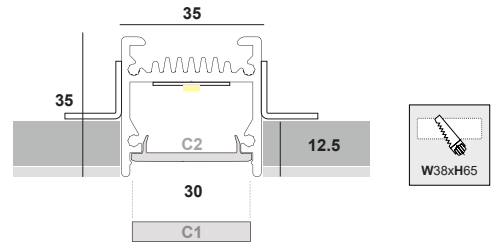

**(-P-)**  
 χωνευτή τοποθέτηση με  
 πλαστικό γωνιόκρανο  
 Trimless Installation with  
 plastic angular

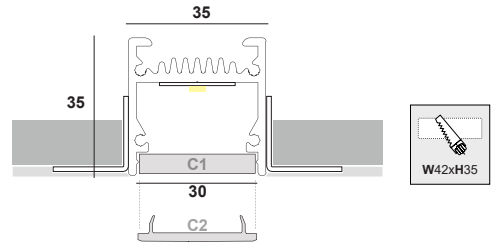

# T35 - XX - XXX - X - XX - X - X

(a)	(b)	(c)	(d)	(e)	(f)	(g)
Κωδικός Γραμμικού Linear Code	Κατηγορία Category	Μήκος Length	Θερμοκρασία φωτός Color Temperature	Κάλυμμα Cover	Αυξομείωση έντασης φωτός Dimming	Χωνευτή τοποθέτηση Trimless installation

## Παράδειγμα κωδικού / Code example

GILA 35×35 TRIMLESS 1A 87cm 3000K Diffuser 1.5m Dimmable with Plastic Angular  
 SKU: T35-1A-87-3-C2-D-P

material	pcb details	CRI	lumen output / W
Extruded aluminium	Zhaga-Compliant Dimensions	Ra>80 ( <b>Ra&gt;90</b> on request)	up to 195 Lm/W

covers	CCT	dimming options (D)
Slide Diffuser 5mm (-C1-)	3000K (3)	Push
	4000K (4)	DALI
Click diffuser 1.5mm ( up to 70m reel ) (-C2-)	5000K (5)	TRIAC 0/1-10V
	6500K (6)	CASAMBI
	TUNABLE 2700K - 6500K (TN)	Analog 0/1-10V



RECESSED TRIMLESS

## GILA 35×35 TRIMLESS / Lumen output tables

CATEGORY 1A 350mA (1A)	code	length	watt	lumens 3000K	lumens 4000K	lumens 5000K	lumens 6500K
	T35-1A-59	59cm	7.8	1390	1470	1470	1440
	T35-1A-87	87cm	11.7	2085	2205	2205	2160
	T35-1A-115	115cm	15.6	2780	2940	2940	2880
	T35-1A-143	143cm	19.5	3475	3675	3675	3600
	T35-1A-171	171cm	23.4	4170	4410	4410	4320
	T35-1A-199	199cm	27.3	4865	5145	5145	5040
	T35-1A-227	227cm	31.2	5560	5880	5880	5760
	T35-1A-255	255cm	35.1	6255	6615	6615	6480
	T35-1A-283	283cm	39	6950	7350	7350	7200
	T35-1A-311	311cm	42.9	7645	8085	8085	7920
	T35-1A-339	339cm	46.8	8340	8820	8820	8640
	T35-1A-367	367cm	50.7	9035	9555	9555	9360
	T35-1A-395	395cm	54.6	9730	10290	10290	10080
	T35-1A-423	423cm	58.5	10425	11025	11025	10800
T35-1A-451	451cm	62.4	11120	11760	11760	11520	

wattage: 13.5 W/m

CATEGORY 1B 500mA (1B)	T35-1B-59	59cm	11.6	1960	2070	2070	2020
	T35-1B-87	87cm	17.4	2940	3105	3105	3030
	T35-1B-115	115cm	23.2	3920	4140	4140	4040
	T35-1B-143	143cm	29	4900	5175	5175	5050
	T35-1B-171	171cm	34.8	5880	6210	6210	6060
	T35-1B-199	199cm	40.6	6860	7245	7245	7070
	T35-1B-227	227cm	46.4	7840	8280	8280	8080
	T35-1B-255	255cm	52.2	8820	9315	9315	9090
	T35-1B-283	283cm	58	9800	10350	10350	10100
	T35-1B-311	311cm	63.8	10780	11385	11385	11110
	T35-1B-339	339cm	69.6	11760	12420	12420	12120
	T35-1B-367	367cm	75.4	12740	13455	13455	13130
	T35-1B-395	395cm	81.2	13720	14490	14490	14140
	T35-1B-423	423cm	87	14700	15525	15525	15150
	T35-1B-451	451cm	92.8	15680	16560	16560	16160

wattage: 20 W/m

Το φωτιστικό είναι διαθέσιμο σε μήκος πολλαπλάσιο των 14 εκατοστών

The illuminant is available in lengths that are multiples of 14 centimeters.

## GILA 35×35 TRIMLESS / Lumen output tables

CATEGORY 2A 350mA (2A)	code	length	watt	lumens 3000K	lumens 4000K	lumens 5000K	lumens 6500K
	T35-2A-59	59cm	23.6	4080	4380	4380	4080
	T35-2A-87	87cm	35.4	6120	6570	6570	6120
	T35-2A-115	115cm	47.2	8160	8760	8760	8160
	T35-2A-143	143cm	59	10200	10950	10950	10200
	T35-2A-171	171cm	70.8	12240	13140	13140	12240
	T35-2A-199	199cm	82.6	14280	15330	15330	14280
	T35-2A-227	227cm	94.4	16320	17520	17520	16320
	T35-2A-255	255cm	106.2	18360	19710	19710	18360
	T35-2A-283	283cm	118	20400	21900	21900	20400
	T35-2A-311	311cm	129.8	22440	24090	24090	22440
	T35-2A-339	339cm	141.6	24480	26280	26280	24480
	T35-2A-367	367cm	153.4	26520	28470	28470	26520
	T35-2A-395	395cm	165.2	28560	30660	30660	28560
T35-2A-423	423cm	177	30600	32850	32850	30600	
T35-2A-451	451cm	188.8	32640	35040	35040	32640	

wattage: 40.5 W/m

T35-2B-59	59cm	35	5700	6140	6140	5700
T35-2B-87	87cm	52.5	8550	9210	9210	8550
T35-2B-115	115cm	70	11400	12280	12280	11400
T35-2B-143	143cm	87.5	14250	15350	15350	14250
T35-2B-171	171cm	105	17100	18420	18420	17100
T35-2B-199	199cm	122.5	19950	21490	21490	19950
T35-2B-227	227cm	140	22800	24560	24560	22800
T35-2B-255	255cm	157.5	25650	27630	27630	25650
T35-2B-283	283cm	175	28500	30700	30700	28500
T35-2B-311	311cm	192.5	31350	33770	33770	31350
T35-2B-339	339cm	210	34200	36840	36840	34200
T35-2B-367	367cm	227.5	37050	39910	39910	37050
T35-2B-395	395cm	245	39900	42980	42980	39900
T35-2B-423	423cm	262.5	42750	46050	46050	42750
T35-2B-451	451cm	280	45600	49120	49120	45600

wattage: 60.5 W/m

Το φωτιστικό είναι διαθέσιμο σε μήκος πολλαπλάσιο των 14 εκατοστών

The illuminant is available in lengths that are multiples of 14 centimeters.

LENA 55x35 TRIMLESS (T5535-)



**(-M-)**  
 χωνευτή τοποθέτηση με  
 γωνιόκρανο αλουμινίου  
 Trimless Installation with  
 aluminium angular

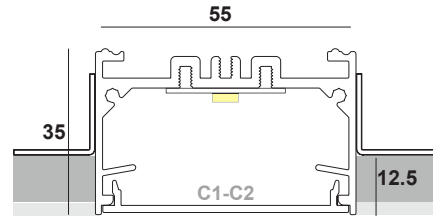

**(-P-)**  
 χωνευτή τοποθέτηση με  
 πλαστικό γωνιόκρανο  
 Trimless Installation with  
 plastic angular

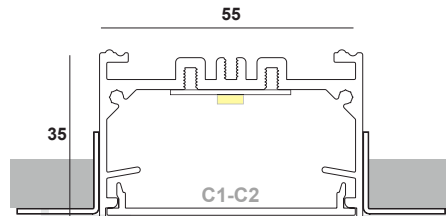

T5535 - XX - XXX - X - XX - X - X

(a)	(b)	(c)	(d)	(e)	(f)	(g)
Κωδικός Γραμμικού Linear Code	Κατηγορία Category	Μήκος Length	Θερμοκρασία φωτός Color Temperature	Κάλυμμα Cover	Αυξομείωση έντασης φωτός Dimming	Χωνευτή τοποθέτηση Trimless installation

**Παράδειγμα κωδικού / Code example**

LENA 55x35 TRIMLESS 1A 85cm 3000K Diffuser Dimmable with Plastic Angular  
**SKU:** T5535-1A-85-3-C2-D-P

material	pcb details	CRI	lumen output / W
Extruded aluminium	Zhaga-Compliant Dimensions	Ra>80 ( <b>Ra&gt;90</b> on request)	up to 195 Lm/W

covers	CCT	dimming options (D)
Acrylic Diffuser (-C1-)	3000K (3)	Push
	4000K (4)	DALI
Acrylic Microprismatic (-C2-)	5000K (5)	TRIAC 0/1-10V
	6500K (6)	CASAMBI
	TUNABLE 2700K - 6500K (TN)	Analog 0/1-10V





RECESSED TRIMLESS

## LENA 55×35 TRIMLESS / Lumen output tables

CATEGORY 1A 350mA (1A)	code	length	watt	lumens 3000K	lumens 4000K	lumens 5000K	lumens 6500K
	T5535-1A-57	57cm	7.8	1390	1470	1470	1440
	T5535-1A-85	85cm	11.7	2085	2205	2205	2160
	T5535-1A-113	113cm	15.6	2780	2940	2940	2880
	T5535-1A-141	141cm	19.5	3475	3675	3675	3600
	T5535-1A-169	169cm	23.4	4170	4410	4410	4320
	T5535-1A-197	197cm	27.3	4865	5145	5145	5040
	T5535-1A-225	225cm	31.2	5560	5880	5880	5760
	T5535-1A-253	253cm	35.1	6255	6615	6615	6480
	T5535-1A-281	281cm	39	6950	7350	7350	7200
	T5535-1A-309	309cm	42.9	7645	8085	8085	7920
	T5535-1A-337	337cm	46.8	8340	8820	8820	8640
	T5535-1A-365	365cm	50.7	9035	9555	9555	9360
	T5535-1A-393	393cm	54.6	9730	10290	10290	10080
	T5535-1A-421	421cm	58.5	10425	11025	11025	10800
T5535-1A-449	449cm	62.4	11120	11760	11760	11520	

wattage: 13.5 W/m

T5535-1B-57	57cm	11.6	1960	2070	2070	2020
T5535-1B-85	85cm	17.4	2940	3105	3105	3030
T5535-1B-113	113cm	23.2	3920	4140	4140	4040
T5535-1B-141	141cm	29	4900	5175	5175	5050
T5535-1B-169	169cm	34.8	5880	6210	6210	6060
T5535-1B-197	197cm	40.6	6860	7245	7245	7070
T5535-1B-225	225cm	46.4	7840	8280	8280	8080
T5535-1B-253	253cm	52.2	8820	9315	9315	9090
T5535-1B-281	281cm	58	9800	10350	10350	10100
T5535-1B-309	309cm	63.8	10780	11385	11385	11110
T5535-1B-337	337cm	69.6	11760	12420	12420	12120
T5535-1B-365	365cm	75.4	12740	13455	13455	13130
T5535-1B-393	393cm	81.2	13720	14490	14490	14140
T5535-1B-421	421cm	87	14700	15525	15525	15150
T5535-1B-449	449cm	92.8	15680	16560	16560	16160

wattage: 20 W/m

Το φωτιστικό είναι διαθέσιμο σε μήκος πολλαπλάσιο των 14 εκατοστών

The illuminant is available in lengths that are multiples of 14 centimeters.



## LENA 55×35 TRIMLESS / Lumen output tables

CATEGORY 2A 350mA (2A)	code	length	watt	lumens 3000K	lumens 4000K	lumens 5000K	lumens 6500K
	T5535-2A-57	57cm	23.6	4080	4380	4380	4080
	T5535-2A-85	85cm	35.4	6120	6570	6570	6120
	T5535-2A-113	113cm	47.2	8160	8760	8760	8160
	T5535-2A-141	141cm	59	10200	10950	10950	10200
	T5535-2A-169	169cm	70.8	12240	13140	13140	12240
	T5535-2A-197	197cm	82.6	14280	15330	15330	14280
	T5535-2A-225	225cm	94.4	16320	17520	17520	16320
	T5535-2A-253	253cm	106.2	18360	19710	19710	18360
	T5535-2A-281	281cm	118	20400	21900	21900	20400
	T5535-2A-309	309cm	129.8	22440	24090	24090	22440
	T5535-2A-337	337cm	141.6	24480	26280	26280	24480
	T5535-2A-365	365cm	153.4	26520	28470	28470	26520
	T5535-2A-393	393cm	165.2	28560	30660	30660	28560
	T5535-2A-421	421cm	177	30600	32850	32850	30600
T5535-2A-449	449cm	188.8	32640	35040	35040	32640	

wattage: 40.5 W/m

T5535-2B-57	57cm	35	5700	6140	6140	5700
T5535-2B-85	85cm	52.5	8550	9210	9210	8550
T5535-2B-113	113cm	70	11400	12280	12280	11400
T5535-2B-141	141cm	87.5	14250	15350	15350	14250
T5535-2B-169	169cm	105	17100	18420	18420	17100
T5535-2B-197	197cm	122.5	19950	21490	21490	19950
T5535-2B-225	225cm	140	22800	24560	24560	22800
T5535-2B-253	253cm	157.5	25650	27630	27630	25650
T5535-2B-281	281cm	175	28500	30700	30700	28500
T5535-2B-309	309cm	192.5	31350	33770	33770	31350
T5535-2B-337	337cm	210	34200	36840	36840	34200
T5535-2B-365	365cm	227.5	37050	39910	39910	37050
T5535-2B-393	393cm	245	39900	42980	42980	39900
T5535-2B-421	421cm	262.5	42750	46050	46050	42750
T5535-2B-449	449cm	280	45600	49120	49120	45600

wattage: 60.5 W/m

Το φωτιστικό είναι διαθέσιμο σε μήκος πολλαπλάσιο των 14 εκατοστών

The illuminant is available in lengths that are multiples of 14 centimeters.

DARK LENA 55x35 TRIMLESS (TD5535-)

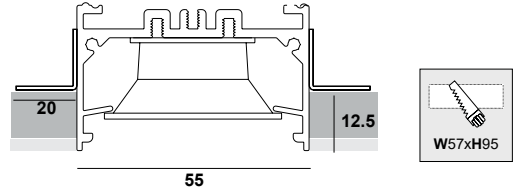

**(-M-)**

χωνευτή τοποθέτηση με γωνιόκρανο αλουμινίου  
Trimless Installation with aluminium angular

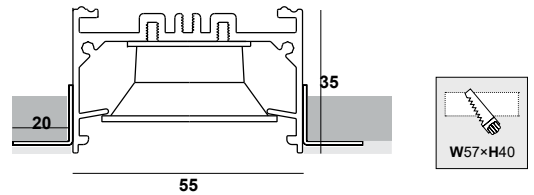

**(-P-)**

χωνευτή τοποθέτηση με πλαστικό γωνιόκρανο  
Trimless Installation with plastic angular

material	pcb details	CRI	lumen output / W
Extruded aluminium / Plastic	SMD light & dark 7x1	Ra>90 ( <b>Ra&gt;80</b> on request)	up to 205 Lm/W

CCT	beam angle	reflector color	dimming options (D)
3000K <b>(3)</b>	Medium 65D <b>(60D)</b>	Black <b>(1)</b>	Push
4000K <b>(4)</b>	Wide 90D <b>(90D)</b>	White <b>(2)</b>	DALI
5000K <b>(5)</b>			TRIAC 0/1-10V
6500K <b>(6)</b>			CASAMBI
TUNABLE 2700K - 6500K <b>(TN)</b>			Analog 0/1-10V

## DARK LENA 55×35 TRIMLESS / Lumen output tables

CATEGORY 1A 350mA (1A)	code	length	watt	lumens 3000K (65D)	lumens 3000K (90D)	lumens 4000K (65D)	lumens 4000K (90D)
	TD5535-1A-56.5	56.5cm	13.4	1702	1680	1774	1752
	TD5535-1A-84.5	84.5cm	20.1	2553	2520	2661	2628
	TD5535-1A-112.5	112.5cm	26.8	3404	3360	3548	3504
	TD5535-1A-140.5	140.5cm	33.5	4255	4200	4435	4380
	TD5535-1A-168.5	168.5cm	40.2	5106	5040	5322	5256
	TD5535-1A-196.5	196.5cm	46.9	5957	5880	6209	6132
	TD5535-1A-224.5	224.5cm	53.6	6808	6720	7096	7008
	TD5535-1A-252.5	252.5cm	60.3	7659	7560	7983	7884
	TD5535-1A-280.5	280.5cm	67	8510	8400	8870	8760
	TD5535-1A-308.5	308.5cm	73.7	9361	9240	9757	9636
	TD5535-1A-336.5	336.5cm	80.4	10212	10080	10644	10512
	TD5535-1A-364.5	364.5cm	87.1	11063	10920	11531	11388
	TD5535-1A-392.5	392.5cm	93.8	11914	11760	12418	12264
	TD5535-1A-420.5	420.5cm	100.5	12765	12600	13305	13140
	TD5535-1A-448.5	448.5cm	107.2	13616	13440	14192	14016

wattage: 23 W/m

TD5535-1B-56.5	56.5cm	19.8	2398	2368	2512	2480
TD5535-1B-84.5	84.5cm	29.7	3597	3552	3768	3720
TD5535-1B-112.5	112.5cm	39.6	4796	4736	5024	4960
TD5535-1B-140.5	140.5cm	49.5	5995	5920	6280	6200
TD5535-1B-168.5	168.5cm	59.4	7194	7104	7536	7440
TD5535-1B-196.5	196.5cm	69.3	8393	8288	8792	8680
TD5535-1B-224.5	224.5cm	79.2	9592	9472	10048	9920
TD5535-1B-252.5	252.5cm	89.1	10791	10656	11304	11160
TD5535-1B-280.5	280.5cm	99	11990	11840	12560	12400
TD5535-1B-308.5	308.5cm	108.9	13189	13024	13816	13640
TD5535-1B-336.5	336.5cm	118.8	14388	14208	15072	14880
TD5535-1B-364.5	364.5cm	128.7	15587	15392	16328	16120
TD5535-1B-392.5	392.5cm	138.6	16786	16576	17584	17360
TD5535-1B-420.5	420.5cm	148.5	17985	17760	18840	18600
TD5535-1B-448.5	448.5cm	158.4	19184	18944	20096	19840

wattage: 34 W/m

Το φωτιστικό είναι διαθέσιμο σε μήκος πολλαπλάσιο των 28 εκατοστών

The illuminant is available in lengths that are multiples of 28 centimeters.

TD5535	-	XX	-	XXX	-	X	-	XXX	-	X	-	X	-	X
(a)		(b)		(c)		(d)		(e)		(f)		(g)		(h)
Κωδικός Γραμμικού Linear Code		Κατηγορία Category		Μήκος Length		Θερμοκρασία φωτός Color Temperature		Γωνία Δέσμης Beam Angle		Χρώμα Ρεφλέκτορα Reflector Color		Αυξομείωση έντασης φωτός Dimming		Χωνευτή τοποθέτηση Trimless installation

### Παράδειγμα κωδικού / Code example

DARK LENA 55×35 TRIMLESS 1A 84.5cm 3000K 65D Black Reflector Dimmable with Plastic Angular

SKU: TD5535-1A-84-3-60D-1-D-P

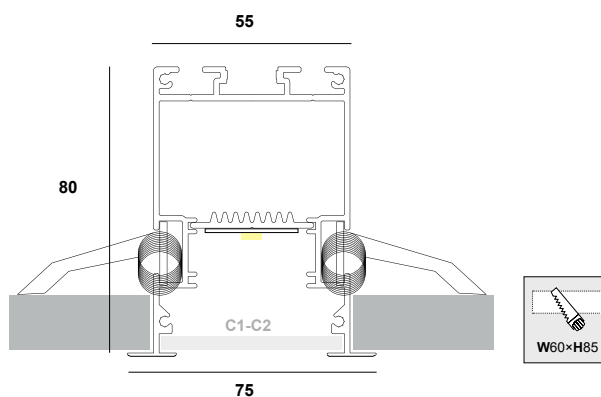

# T5580 - XX - XXX - X - XX - XX - X

- (a)  
Κωδικός Γραμμικού  
Linear Code
- (b)  
Κατηγορία  
Category
- (c)  
Μήκος  
Length
- (d)  
Θερμοκρασία  
φωτός  
Color  
Temperature
- (e)  
Χρώμα  
προφίλ  
Profile  
Color
- (e)  
Κάλυμμα  
Cover
- (f)  
Αυτομείωση  
έντασης φωτός  
Dimming

**Παράδειγμα κωδικού / Code example**

NILE 55×80 RECESSED 1A 85cm 3000K Black Diffuser Dimmable

SKU: T5580-1A-85-3-BL-C1-D

material	pcb details	CRI	lumen output / W
Extruded aluminium	Zhaga-Compliant Dimensions	Ra>80 (Ra>90 on request)	up to 195 Lm/W

covers	profile color	CCT	dimming options (D)
Diffuser 3mm (-C1-)	Anodised (AN)	3000K (3)	Push
	Black (BL)	4000K (4)	DALI
Microprismatic 3mm (-C2-)	White (WH)	5000K (5)	TRIAC 0/1-10V
	RAL (RL)	6500K (6)	CASAMBI
		TUNABLE 2700K - 6500K (TN)	Analog 0/1-10V



RECESSED TRIMLESS

## NILE 55×80 RECESSED / Lumen output tables

CATEGORY 1A 350mA (1A)	code	length	watt	lumens 3000K	lumens 4000K	lumens 5000K	lumens 6500K
	T5580-1A-57	57cm	7.8	1390	1470	1470	1440
	T5580-1A-85	85cm	11.7	2085	2205	2205	2160
	T5580-1A-113	113cm	15.6	2780	2940	2940	2880
	T5580-1A-141	141cm	19.5	3475	3675	3675	3600
	T5580-1A-169	169cm	23.4	4170	4410	4410	4320
	T5580-1A-197	197cm	27.3	4865	5145	5145	5040
	T5580-1A-225	225cm	31.2	5560	5880	5880	5760
	T5580-1A-253	253cm	35.1	6255	6615	6615	6480
	T5580-1A-281	281cm	39	6950	7350	7350	7200
	T5580-1A-309	309cm	42.9	7645	8085	8085	7920
	T5580-1A-337	337cm	46.8	8340	8820	8820	8640
	T5580-1A-365	365cm	50.7	9035	9555	9555	9360
	T5580-1A-393	393cm	54.6	9730	10290	10290	10080
	T5580-1A-421	421cm	58.5	10425	11025	11025	10800
T5580-1A-449	449cm	62.4	11120	11760	11760	11520	

wattage: 13.5 W/m

T5580-1B-57	57cm	11.6	1960	2070	2070	2020
T5580-1B-85	85cm	17.4	2940	3105	3105	3030
T5580-1B-113	113cm	23.2	3920	4140	4140	4040
T5580-1B-141	141cm	29	4900	5175	5175	5050
T5580-1B-169	169cm	34.8	5880	6210	6210	6060
T5580-1B-197	197cm	40.6	6860	7245	7245	7070
T5580-1B-225	225cm	46.4	7840	8280	8280	8080
T5580-1B-253	253cm	52.2	8820	9315	9315	9090
T5580-1B-281	281cm	58	9800	10350	10350	10100
T5580-1B-309	309cm	63.8	10780	11385	11385	11110
T5580-1B-337	337cm	69.6	11760	12420	12420	12120
T5580-1B-365	365cm	75.4	12740	13455	13455	13130
T5580-1B-393	393cm	81.2	13720	14490	14490	14140
T5580-1B-421	421cm	87	14700	15525	15525	15150
T5580-1B-449	449cm	92.8	15680	16560	16560	16160

wattage: 20 W/m

Το φωτιστικό είναι διαθέσιμο σε μήκος πολλαπλάσιο των 14 εκατοστών

The illuminant is available in lengths that are multiples of 14 centimeters.



## NILE 55×80 RECESSED / Lumen output tables

CATEGORY 2A 350mA (2A)	code	length	watt	lumens 3000K	lumens 4000K	lumens 5000K	lumens 6500K
	T5580-2A-57	57cm	23.6	4080	4380	4380	4080
	T5580-2A-85	85cm	35.4	6120	6570	6570	6120
	T5580-2A-113	113cm	47.2	8160	8760	8760	8160
	T5580-2A-141	141cm	59	10200	10950	10950	10200
	T5580-2A-169	169cm	70.8	12240	13140	13140	12240
	T5580-2A-197	197cm	82.6	14280	15330	15330	14280
	T5580-2A-225	225cm	94.4	16320	17520	17520	16320
	T5580-2A-253	253cm	106.2	18360	19710	19710	18360
	T5580-2A-281	281cm	118	20400	21900	21900	20400
	T5580-2A-309	309cm	129.8	22440	24090	24090	22440
	T5580-2A-337	337cm	141.6	24480	26280	26280	24480
	T5580-2A-365	365cm	153.4	26520	28470	28470	26520
	T5580-2A-393	393cm	165.2	28560	30660	30660	28560
	T5580-2A-421	421cm	177	30600	32850	32850	30600
T5580-2A-449	449cm	188.8	32640	35040	35040	32640	

wattage: 40.5 W/m

CATEGORY 2B 500mA (2B)	code	length	watt	lumens 3000K	lumens 4000K	lumens 5000K	lumens 6500K
	T5580-2B-57	57cm	35	5700	6140	6140	5700
	T5580-2B-85	85cm	52.5	8550	9210	9210	8550
	T5580-2B-113	113cm	70	11400	12280	12280	11400
	T5580-2B-141	141cm	87.5	14250	15350	15350	14250
	T5580-2B-169	169cm	105	17100	18420	18420	17100
	T5580-2B-197	197cm	122.5	19950	21490	21490	19950
	T5580-2B-225	225cm	140	22800	24560	24560	22800
	T5580-2B-253	253cm	157.5	25650	27630	27630	25650
	T5580-2B-281	281cm	175	28500	30700	30700	28500
	T5580-2B-309	309cm	192.5	31350	33770	33770	31350
	T5580-2B-337	337cm	210	34200	36840	36840	34200
	T5580-2B-365	365cm	227.5	37050	39910	39910	37050
	T5580-2B-393	393cm	245	39900	42980	42980	39900
	T5580-2B-421	421cm	262.5	42750	46050	46050	42750
T5580-2B-449	449cm	280	45600	49120	49120	45600	

wattage: 60.5 W/m

Το φωτιστικό είναι διαθέσιμο σε μήκος πολλαπλάσιο των 14 εκατοστών

The illuminant is available in lengths that are multiples of 14 centimeters.

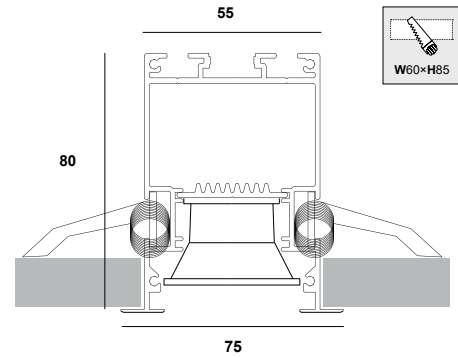

TD5580 - XX - XXX - X - XXX - XX - X - X

(a)	(b)	(c)	(d)	(e)	(f)	(g)	(h)
Κωδικός Γραμμικού Linear Code	Κατηγορία Category	Μήκος Length	Θερμοκρασία φωτός Color Temperature	Γωνία Δέσμης Beam Angle	Χρώμα προφίλ Profile Color	Χρώμα Ρεφλέκτορα Reflector Color	Αυξομείωση έντασης φωτός Dimming

**Παράδειγμα κωδικού / Code example**

DARK NILE 55×80 RECESSED 1A 84.5cm 3000K 65D Black with Black Reflector Dimmable  
SKU: TD5580-1A-85-3-60D-BL-1-D

material	pcb details	CRI	lumen output / W
Extruded aluminium / Plastic	SMD light & dark 7×1	Ra>90 (Ra>80 on request)	up to 205 Lm/W

CCT	beam angle	profile color	reflector color	dimming options (D)
3000K (3)	Medium 65D (60D)	Anodised (AN)	Black (1)	Push
4000K (4)	Wide 90D (90D)	Black (BL)	White (2)	DALI
5000K (5)		White (WH)		TRIAC 0/1-10V
6500K (6)		RAL (RL)		CASAMBI
TUNABLE 2700K - 6500K (TN)				Analog 0/1-10V

**Εναλλακτική τοποθέτηση φακού / Alternative lens placement**

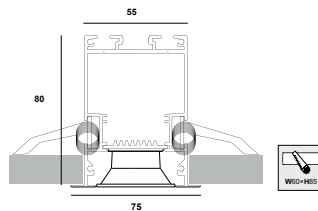



## DARK NILE 55×80 RECESSED / Lumen output tables

CATEGORY 1A 350mA (1A)	code	length	watt	lumens 3000K (65D)	lumens 3000K (90D)	lumens 4000K (65D)	lumens 4000K (90D)
	TD5580-1A-56.5	56.5cm	13.4	1702	1680	1774	1752
	TD5580-1A-84.5	84.5cm	20.1	2553	2520	2661	2628
	TD5580-1A-112.5	112.5cm	26.8	3404	3360	3548	3504
	TD5580-1A-140.5	140.5cm	33.5	4255	4200	4435	4380
	TD5580-1A-168.5	168.5cm	40.2	5106	5040	5322	5256
	TD5580-1A-196.5	196.5cm	46.9	5957	5880	6209	6132
	TD5580-1A-224.5	224.5cm	53.6	6808	6720	7096	7008
	TD5580-1A-252.5	252.5cm	60.3	7659	7560	7983	7884
	TD5580-1A-280.5	280.5cm	67	8510	8400	8870	8760
	TD5580-1A-308.5	308.5cm	73.7	9361	9240	9757	9636
	TD5580-1A-336.5	336.5cm	80.4	10212	10080	10644	10512
	TD5580-1A-364.5	364.5cm	87.1	11063	10920	11531	11388
	TD5580-1A-392.5	392.5cm	93.8	11914	11760	12418	12264
	TD5580-1A-420.5	420.5cm	100.5	12765	12600	13305	13140
	TD5580-1A-448.5	448.5cm	107.2	13616	13440	14192	14016

wattage: 23 W/m

CATEGORY 1B 500mA (1B)	code	length	watt	lumens 3000K (65D)	lumens 3000K (90D)	lumens 4000K (65D)	lumens 4000K (90D)
	TD5580-1B-56.5	56.5cm	19.8	2398	2368	2512	2480
	TD5580-1B-84.5	84.5cm	29.7	3597	3552	3768	3720
	TD5580-1B-112.5	112.5cm	39.6	4796	4736	5024	4960
	TD5580-1B-140.5	140.5cm	49.5	5995	5920	6280	6200
	TD5580-1B-168.5	168.5cm	59.4	7194	7104	7536	7440
	TD5580-1B-196.5	196.5cm	69.3	8393	8288	8792	8680
	TD5580-1B-224.5	224.5cm	79.2	9592	9472	10048	9920
	TD5580-1B-252.5	252.5cm	89.1	10791	10656	11304	11160
	TD5580-1B-280.5	280.5cm	99	11990	11840	12560	12400
	TD5580-1B-308.5	308.5cm	108.9	13189	13024	13816	13640
	TD5580-1B-336.5	336.5cm	118.8	14388	14208	15072	14880
	TD5580-1B-364.5	364.5cm	128.7	15587	15392	16328	16120
	TD5580-1B-392.5	392.5cm	138.6	16786	16576	17584	17360
	TD5580-1B-420.5	420.5cm	148.5	17985	17760	18840	18600
	TD5580-1B-448.5	448.5cm	158.4	19184	18944	20096	19840

wattage: 34 W/m

*Το φωτιστικό είναι διαθέσιμο σε μήκος πολλαπλάσιο των 28 εκατοστών*

*The illuminant is available in lengths that are multiples of 28 centimeters.*



ΕΠΙΤΟΙΧΑ / SURFACE MOUNTED

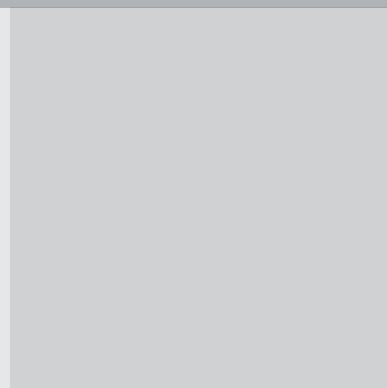

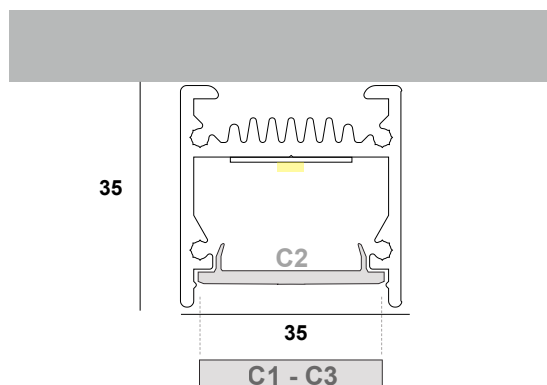

35 - XX - XXX - X - XX - XX - X - XXX

(a) (b) (c) (d) (e) (f) (g) (h)

Κωδικός Γραμμικού / Linear Code    Κατηγορία / Category    Μήκος / Length    Θερμοκρασία φωτός / Color Temperature    Χρώμα προφίλ / Profile color    Κάλυμμα / Cover    Αυξομείωση έντασης φωτός / Dimming    Τοποθέτηση τροφοδοτικού / Power supply installation

**Παράδειγμα κωδικού / Code example**

GILA 35×35 88cm 1A 3000K Black Dimmable with Slide Diffuser 1.5mm (Hidden power supply)

SKU: 35-1A-88-3-C2-D-PS2

material	pcb details	CRI	lumen output / W
Extruded aluminium	Zhaga-Compliant Dimensions	Ra>80 (Ra>90 on request)	up to 195 Lm/W

covers	profile color	CCT	dimming options (D)
Slide Diffuser 5mm (-C1-)	Anodised (AN)	3000K (3)	Push
	Black (BL)	4000K (4)	DALI
	White (WH)	5000K (5)	TRIAC 0/1-10V
Click diffuser 1.5mm (up to 70m reel) (-C2-)	RAL (RL)	6500K (6)	CASAMBI
		TUNABLE 2700K - 6500K (TN)	Analog 0/1-10V
Microprismatic (-C3-)			

power supply installation	
<p>Πάνω στο προφίλ με ροζέτα On the profile with rosette (-PS1-)</p>	<p>Κρυφό με πρόσβαση στο τροφοδοτικό Hidden with access to the power supply (-PS2-)</p>



SURFACE MOUNTED

## GILA 35×35 / Lumen output tables

	code	length	watt	lumens 3000K	lumens 4000K	lumens 5000K	lumens 6500K
CATEGORY 1A 350mA (1A)	35-1A-60	60cm	7.8	1390	1470	1470	1440
	35-1A-88	88cm	11.7	2085	2205	2205	2160
	35-1A-116	116cm	15.6	2780	2940	2940	2880
	35-1A-144	144cm	19.5	3475	3675	3675	3600
	35-1A-173	173cm	23.4	4170	4410	4410	4320
	35-1A-201	201cm	27.3	4865	5145	5145	5040
	35-1A-229	229cm	31.2	5560	5880	5880	5760
	35-1A-257	257cm	35.1	6255	6615	6615	6480
	35-1A-285	285cm	39	6950	7350	7350	7200
	35-1A-313	313cm	42.9	7645	8085	8085	7920
	35-1A-342	342cm	46.8	8340	8820	8820	8640
	35-1A-370	370cm	50.7	9035	9555	9555	9360
	35-1A-399	399cm	54.6	9730	10290	10290	10080
	35-1A-427	427cm	58.5	10425	11025	11025	10800
	35-1A-455	455cm	62.4	11120	11760	11760	11520

wattage: 13.5 W/m

CATEGORY 1B 500mA (1B)	35-1B-60	60cm	11.6	1960	2070	2070	2020
	35-1B-88	88cm	17.4	2940	3105	3105	3030
	35-1B-116	116cm	23.2	3920	4140	4140	4040
	35-1B-144	144cm	29	4900	5175	5175	5050
	35-1B-173	173cm	34.8	5880	6210	6210	6060
	35-1B-201	201cm	40.6	6860	7245	7245	7070
	35-1B-229	229cm	46.4	7840	8280	8280	8080
	35-1B-257	257cm	52.2	8820	9315	9315	9090
	35-1B-285	285cm	58	9800	10350	10350	10100
	35-1B-313	313cm	63.8	10780	11385	11385	11110
	35-1B-342	342cm	69.6	11760	12420	12420	12120
	35-1B-370	370cm	75.4	12740	13455	13455	13130
	35-1B-399	399cm	81.2	13720	14490	14490	14140
	35-1B-427	427cm	87	14700	15525	15525	15150
	35-1B-455	455cm	92.8	15680	16560	16560	16160

wattage: 20 W/m

Το φωτιστικό είναι διαθέσιμο σε μήκος πολλαπλάσιο των 14 εκατοστών

The illuminant is available in lengths that are multiples of 14 centimeters.

## GILA 35×35 / Lumen output tables

CATEGORY 2A 350mA (2A)	code	length	watt	lumens 3000K	lumens 4000K	lumens 5000K	lumens 6500K
	35-2A-60	60cm	23.6	4080	4380	4380	4080
	35-2A-88	88cm	35.4	6120	6570	6570	6120
	35-2A-116	116cm	47.2	8160	8760	8760	8160
	35-2A-144	144cm	59	10200	10950	10950	10200
	35-2A-173	173cm	70.8	12240	13140	13140	12240
	35-2A-201	201cm	82.6	14280	15330	15330	14280
	35-2A-229	229cm	94.4	16320	17520	17520	16320
	35-2A-257	257cm	106.2	18360	19710	19710	18360
	35-2A-284	285cm	118	20400	21900	21900	20400
	35-2A-313	313cm	129.8	22440	24090	24090	22440
	35-2A-342	342cm	141.6	24480	26280	26280	24480
	35-2A-370	370cm	153.4	26520	28470	28470	26520
	35-2A-399	399cm	165.2	28560	30660	30660	28560
	35-2A-427	427cm	177	30600	32850	32850	30600
35-2A-455	455cm	188.8	32640	35040	35040	32640	

wattage: 40.5 W/m

35-2B-60	60cm	35	5700	6140	6140	5700
35-2B-88	88cm	52.5	8550	9210	9210	8550
35-2B-116	116cm	70	11400	12280	12280	11400
35-2B-144	144cm	87.5	14250	15350	15350	14250
35-2B-173	173cm	105	17100	18420	18420	17100
35-2B-201	201cm	122.5	19950	21490	21490	19950
35-2B-229	229cm	140	22800	24560	24560	22800
35-2B-257	257cm	157.5	25650	27630	27630	25650
35-2B-285	285cm	175	28500	30700	30700	28500
35-2B-313	313cm	192.5	31350	33770	33770	31350
35-2B-342	342cm	210	34200	36840	36840	34200
35-2B-370	370cm	227.5	37050	39910	39910	37050
35-2B-399	399cm	245	39900	42980	42980	39900
35-2B-427	427cm	262.5	42750	46050	46050	42750
35-2B-455	455cm	280	45600	49120	49120	45600

wattage: 60.5 W/m

Το φωτιστικό είναι διαθέσιμο σε μήκος πολλαπλάσιο των 14 εκατοστών  
 The illuminant is available in lengths that are multiples of 14 centimeters.

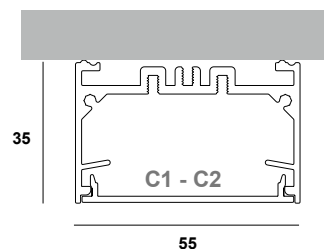

5535 - XX - XXX - X - XX - XX - X



(a)	(b)	(c)	(d)	(e)	(f)	(g)
Κωδικός Γραμμικού Linear Code	Κατηγορία Category	Μήκος Length	Θερμοκρασία φωτός Color Temperature	Χρώμα προφίλ Profile color	Κάλυμμα Cover	Αυξομείωση έντασης φωτός Dimming

**Παράδειγμα κωδικού / Code example**



LENA 55×35 85cm 1A 3000K Black with Diffuser Dimmable (Hidden power supply)

SKU: 5535-1A-85-3-BL-C1-D-PS3

material	pcb details	CRI	lumen output / W
Extruded aluminium	Zhaga-Compliant Dimensions	Ra>80 (Ra>90 on request)	up to 195 Lm/W

covers	profile color	CCT	dimming options (D)
Acrylic Diffuser (-C1-) 	Anodised (AN)	3000K (3)	Push
	Black (BL)	4000K (4)	DALI
	White (WH)	5000K (5)	TRIAC 0/1-10V
Acrylic Microprismatic (-C2-) 	RAL (RL)	6500K (6)	CASAMBI
		TUNABLE 2700K - 6500K (TN)	Analog 0/1-10V

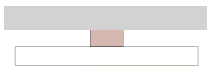
**power supply installation**

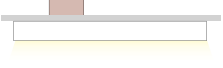
 <p>Πάνω στο προφίλ με ροζέτα On the profile with rosette (-PS1-)</p>	 <p>Δίπλα στο προφίλ To the side of the profile (-PS2-)</p>	 <p>Κρυφό με πρόσβαση στο τροφοδοτικό Hidden with access to the power supply (-PS3-)</p>
------------------------------------------------------------------------------------------------------------------------------------------------------------------	--------------------------------------------------------------------------------------------------------------------------------------------------------	---------------------------------------------------------------------------------------------------------------------------------------------------------------------------------------





SURFACE MOUNTED



## LENA 55×35 / Lumen output tables

CATEGORY 1A 350mA (1A)	code	length	watt	lumens 3000K	lumens 4000K	lumens 5000K	lumens 6500K
	5535-1A-57	57cm	7.8	1390	1470	1470	1440
	5535-1A-85	85cm	11.7	2085	2205	2205	2160
	5535-1A-113	113cm	15.6	2780	2940	2940	2880
	5535-1A-141	141cm	19.5	3475	3675	3675	3600
	5535-1A-169	169cm	23.4	4170	4410	4410	4320
	5535-1A-197	197cm	27.3	4865	5145	5145	5040
	5535-1A-225	225cm	31.2	5560	5880	5880	5760
	5535-1A-253	253cm	35.1	6255	6615	6615	6480
	5535-1A-281	281cm	39	6950	7350	7350	7200
	5535-1A-309	309cm	42.9	7645	8085	8085	7920
	5535-1A-337	337cm	46.8	8340	8820	8820	8640
	5535-1A-365	365cm	50.7	9035	9555	9555	9360
	5535-1A-393	393cm	54.6	9730	10290	10290	10080
	5535-1A-421	421cm	58.5	10425	11025	11025	10800
5535-1A-449	449cm	62.4	11120	11760	11760	11520	

wattage: 13.5 W/m

5535-1B-57	57cm	11.6	1960	2070	2070	2020
5535-1B-85	85cm	17.4	2940	3105	3105	3030
5535-1B-113	113cm	23.2	3920	4140	4140	4040
5535-1B-141	141cm	29	4900	5175	5175	5050
5535-1B-169	169cm	34.8	5880	6210	6210	6060
5535-1B-197	197cm	40.6	6860	7245	7245	7070
5535-1B-225	225cm	46.4	7840	8280	8280	8080
5535-1B-253	253cm	52.2	8820	9315	9315	9090
5535-1B-281	281cm	58	9800	10350	10350	10100
5535-1B-309	309cm	63.8	10780	11385	11385	11110
5535-1B-337	337cm	69.6	11760	12420	12420	12120
5535-1B-365	365cm	75.4	12740	13455	13455	13130
5535-1B-393	393cm	81.2	13720	14490	14490	14140
5535-1B-421	421cm	87	14700	15525	15525	15150
5535-1B-449	449cm	92.8	15680	16560	16560	16160

wattage: 20 W/m

Το φωτιστικό είναι διαθέσιμο σε μήκος πολλαπλάσιο των 14 εκατοστών

The illuminant is available in lengths that are multiples of 14 centimeters.

## LENA 55×35 / Lumen output tables

CATEGORY 2A 350mA (2A)	code	length	watt	lumens 3000K	lumens 4000K	lumens 5000K	lumens 6500K
	5535-2A-57	57cm	23.6	4080	4380	4380	4080
	5535-2A-85	85cm	35.4	6120	6570	6570	6120
	5535-2A-113	113cm	47.2	8160	8760	8760	8160
	5535-2A-141	141cm	59	10200	10950	10950	10200
	5535-2A-169	169cm	70.8	12240	13140	13140	12240
	5535-2A-197	197cm	82.6	14280	15330	15330	14280
	5535-2A-225	225cm	94.4	16320	17520	17520	16320
	5535-2A-253	253cm	106.2	18360	19710	19710	18360
	5535-2A-281	281cm	118	20400	21900	21900	20400
	5535-2A-309	309cm	129.8	22440	24090	24090	22440
	5535-2A-337	337cm	141.6	24480	26280	26280	24480
	5535-2A-365	365cm	153.4	26520	28470	28470	26520
	5535-2A-393	393cm	165.2	28560	30660	30660	28560
	5535-2A-421	421cm	177	30600	32850	32850	30600
5535-2A-449	449cm	188.8	32640	35040	35040	32640	

wattage: 40.5 W/m

CATEGORY 2B 500mA (2B)	code	length	watt	lumens 3000K	lumens 4000K	lumens 5000K	lumens 6500K
	5535-2B-57	57cm	35	5700	6140	6140	5700
	5535-2B-85	85cm	52.5	8550	9210	9210	8550
	5535-2B-113	113cm	70	11400	12280	12280	11400
	5535-2B-141	141cm	87.5	14250	15350	15350	14250
	5535-2B-169	169cm	105	17100	18420	18420	17100
	5535-2B-197	197cm	122.5	19950	21490	21490	19950
	5535-2B-225	225cm	140	22800	24560	24560	22800
	5535-2B-253	253cm	157.5	25650	27630	27630	25650
	5535-2B-281	281cm	175	28500	30700	30700	28500
	5535-2B-309	309cm	192.5	31350	33770	33770	31350
	5535-2B-337	337cm	210	34200	36840	36840	34200
	5535-2B-365	365cm	227.5	37050	39910	39910	37050
	5535-2B-393	393cm	245	39900	42980	42980	39900
	5535-2B-421	421cm	262.5	42750	46050	46050	42750
5535-2B-449	449cm	280	45600	49120	49120	45600	

wattage: 60.5 W/m

Το φωτιστικό είναι διαθέσιμο σε μήκος πολλαπλάσιο των 14 εκατοστών  
 The illuminant is available in lengths that are multiples of 14 centimeters.

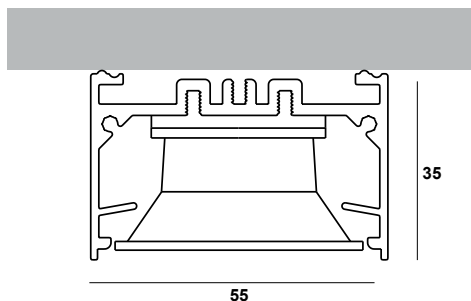

D5535 - XX - XXX - X - XXX - XX - X - X - XXX

(a)	(b)	(c)	(d)	(e)	(f)	(g)	(h)	(i)
Κωδικός Γραμμικού Linear Code	Κατηγορία Category	Μήκος Length	Θερμοκρασία φωτός Color Temperature	Γωνία Δέσμης Beam Angle	Χρώμα προφίλ Profile Color	Χρώμα Ρεφλέκτορα Reflector Color	Αυξομείωση έντασης φωτός Dimming	Τοποθέτηση τροφοδοτικού Power supply installation

Παράδειγμα κωδικού / Code example



DARK LENA 55×35 1A 87cm 3000K 65D Black with Black Reflector Dimmable (Hidden power supply)

SKU: D5535-1A-87-3-60D-BL-1-D-PS3

material	pcb details	CRI	lumen output / W
Extruded aluminium / Plastic	SMD light & dark 7×1	Ra>90 (Ra>80 on request)	up to 205 Lm/W

CCT	beam angle	profile color	reflector color	dimming options (D)
3000K (3)	Medium 65D (60D)	Anodised (AN)	Black (1)	Push
4000K (4)	Wide 90D (90D)	Black (BL)	White (2)	DALI
5000K (5)		White (WH)		TRIAC 0/1-10V
6500K (6)		RAL (RL)	CASAMBI	
TUNABLE 2700K - 6500K (TN)				Analog 0/1-10V

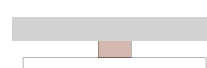
power supply installation

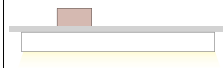
 <p>Πάνω στο προφίλ με ροζέτα On the profile with rosette (-PS1-)</p>	 <p>Δίπλα στο προφίλ To the side of the profile (-PS2-)</p>	 <p>Κρυφό με πρόσβαση στο τροφοδοτικό Hidden with access to the power supply (-PS3-)</p>
------------------------------------------------------------------------------------------------------------------------------------------------------------------	--------------------------------------------------------------------------------------------------------------------------------------------------------	---------------------------------------------------------------------------------------------------------------------------------------------------------------------------------------

## DARK LENA 55×35 / Lumen output tables

CATEGORY 1A 350mA (1A)	code	length	watt	lumens 3000K (65D)	lumens 3000K (90D)	lumens 4000K (65D)	lumens 4000K (90D)
	D5535-1A-59	59cm	13.4	1702	1680	1774	1752
	D5535-1A-87	87cm	20.1	2553	2520	2661	2628
	D5535-1A-115	115cm	26.8	3404	3360	3548	3504
	D5535-1A-143	143cm	33.5	4255	4200	4435	4380
	D5535-1A-171	171cm	40.2	5106	5040	5322	5256
	D5535-1A-200.5	200.5cm	46.9	5957	5880	6209	6132
	D5535-1A-228.5	228.5cm	53.6	6808	6720	7096	7008
	D5535-1A-256.5	256.5cm	60.3	7659	7560	7983	7884
	D5535-1A-284.5	284.5cm	67	8510	8400	8870	8760
	D5535-1A-312.5	312.5cm	73.7	9361	9240	9757	9636
	D5535-1A-340.5	340.5cm	80.4	10212	10080	10644	10512
	D5535-1A-368.5	368.5cm	87.1	11063	10920	11531	11388
	D5535-1A-396.5	396.5cm	93.8	11914	11760	12418	12264
	D5535-1A-424.5	424.5cm	100.5	12765	12600	13305	13140
D5535-1A-452.5	452.5cm	107.2	13616	13440	14192	14016	

wattage: 23 W/m

D5535-1B-59	59cm	19.8	2398	2368	2512	2480
D5535-1B-87	87cm	29.7	3597	3552	3768	3720
D5535-1B-115	115cm	39.6	4796	4736	5024	4960
D5535-1B-143	143cm	49.5	5995	5920	6280	6200
D5535-1B-171	171cm	59.4	7194	7104	7536	7440
D5535-1B-200.5	200.5cm	69.3	8393	8288	8792	8680
D5535-1B-228.5	228.5cm	79.2	9592	9472	10048	9920
D5535-1B-256.5	256.5cm	89.1	10791	10656	11304	11160
D5535-1B-284.5	284.5cm	99	11990	11840	12560	12400
D5535-1B-312.5	312.5cm	108.9	13189	13024	13816	13640
D5535-1B-340.5	340.5cm	118.8	14388	14208	15072	14880
D5535-1B-368.5	368.5cm	128.7	15587	15392	16328	16120
D5535-1B-396.5	396.5cm	138.6	16786	16576	17584	17360
D5535-1B-424.5	424.5cm	148.5	17985	17760	18840	18600
D5535-1B-452.5	452.5cm	158.4	19184	18944	20096	19840

wattage: 34 W/m

Το φωτιστικό είναι διαθέσιμο σε μήκος πολλαπλάσιο των 28 εκατοστών

The illuminant is available in lengths that are multiples of 28 centimeters.

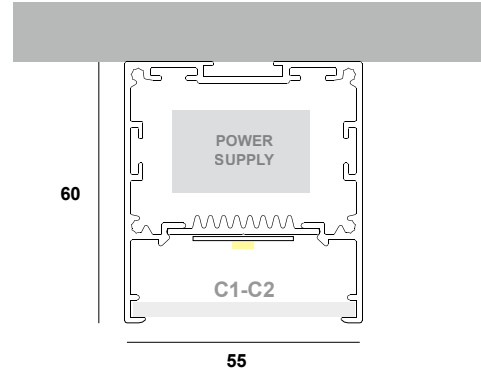



5560 - XX - XXX - X - XX - XX - X

(a)	(b)	(c)	(d)	(e)	(f)	(g)
Κωδικός Γραμμικού Linear Code	Κατηγορία Category	Μήκος Length	Θερμοκρασία φωτός Color Temperature	Χρώμα Color	Κάλυμμα Cover	Αυξομείωση έντασης φωτός Dimming

**Παράδειγμα κωδικού / Code example**

GANGES 55×60 85cm 1A 3000K Black with Diffuser Dimmable  
SKU: 5560-1A-85-3-BL-C1-D

material	pcb details	CRI	lumen output / W
Extruded aluminium	Zhaga-Compliant Dimensions	Ra>80 (Ra>90 on request)	up to 195 Lm/W

covers	profile color	CCT	dimming options (D)
Diffuser 3mm (-C1-) 	Anodised (AN)	3000K (3)	Push
	Black (BL)	4000K (4)	DALI
	White (WH)	5000K (5)	TRIAC 0/1-10V
Microprismatic 3mm (-C2-) 	RAL (RL)	6500K (6)	CASAMBI
		TUNABLE 2700K - 6500K (TN)	Analog 0/1-10V

## GANGES 55×60 / Lumen output tables

CATEGORY 1A 350mA (1A)	code	length	watt	lumens 3000K	lumens 4000K	lumens 5000K	lumens 6500K
	5560-1A-57	57cm	7.8	1390	1470	1470	1440
	5560-1A-85	85cm	11.7	2085	2205	2205	2160
	5560-1A-113	113cm	15.6	2780	2940	2940	2880
	5560-1A-141	141cm	19.5	3475	3675	3675	3600
	5560-1A-169	169cm	23.4	4170	4410	4410	4320
	5560-1A-197	197cm	27.3	4865	5145	5145	5040
	5560-1A-225	225cm	31.2	5560	5880	5880	5760
	5560-1A-253	253cm	35.1	6255	6615	6615	6480
	5560-1A-281	281cm	39	6950	7350	7350	7200
	5560-1A-309	309cm	42.9	7645	8085	8085	7920
	5560-1A-337	337cm	46.8	8340	8820	8820	8640
	5560-1A-365	365cm	50.7	9035	9555	9555	9360
	5560-1A-393	393cm	54.6	9730	10290	10290	10080
	5560-1A-421	421cm	58.5	10425	11025	11025	10800
	5560-1A-449	449cm	62.4	11120	11760	11760	11520

wattage: 13.5 W/m

CATEGORY 1B 500mA (1B)	code	length	watt	lumens 3000K	lumens 4000K	lumens 5000K	lumens 6500K
	5560-1B-57	57cm	11.6	1960	2070	2070	2020
	5560-1B-85	85cm	17.4	2940	3105	3105	3030
	5560-1B-113	113cm	23.2	3920	4140	4140	4040
	5560-1B-141	141cm	29	4900	5175	5175	5050
	5560-1B-169	169cm	34.8	5880	6210	6210	6060
	5560-1B-197	197cm	40.6	6860	7245	7245	7070
	5560-1B-225	225cm	46.4	7840	8280	8280	8080
	5560-1B-253	253cm	52.2	8820	9315	9315	9090
	5560-1B-281	281cm	58	9800	10350	10350	10100
	5560-1B-309	309cm	63.8	10780	11385	11385	11110
	5560-1B-337	337cm	69.6	11760	12420	12420	12120
	5560-1B-365	365cm	75.4	12740	13455	13455	13130
	5560-1B-393	393cm	81.2	13720	14490	14490	14140
	5560-1B-421	421cm	87	14700	15525	15525	15150
	5560-1B-449	449cm	92.8	15680	16560	16560	16160

wattage: 20 W/m

Το φωτιστικό είναι διαθέσιμο σε μήκος πολλαπλάσιο των 14 εκατοστών

The illuminant is available in lengths that are multiples of 14 centimeters.

## GANGES 55×60 / Lumen output tables

	code	length	watt	lumens 3000K	lumens 4000K	lumens 5000K	lumens 6500K
CATEGORY 2A 350mA (2A)	5560-2A-57	57cm	23.6	4080	4380	4380	4080
	5560-2A-85	85cm	35.4	6120	6570	6570	6120
	5560-2A-113	113cm	47.2	8160	8760	8760	8160
	5560-2A-141	141cm	59	10200	10950	10950	10200
	5560-2A-169	169cm	70.8	12240	13140	13140	12240
	5560-2A-197	197cm	82.6	14280	15330	15330	14280
	5560-2A-225	225cm	94.4	16320	17520	17520	16320
	5560-2A-253	253cm	106.2	18360	19710	19710	18360
	5560-2A-281	281cm	118	20400	21900	21900	20400
	5560-2A-309	309cm	129.8	22440	24090	24090	22440
	5560-2A-337	337cm	141.6	24480	26280	26280	24480
	5560-2A-365	365cm	153.4	26520	28470	28470	26520
	5560-2A-393	393cm	165.2	28560	30660	30660	28560
	5560-2A-421	421cm	177	30600	32850	32850	30600
	5560-2A-449	449cm	188.8	32640	35040	35040	32640

wattage: 40.5 W/m

CATEGORY 2B 500mA (2B)	5560-2B-57	57cm	35	5700	6140	6140	5700
	5560-2B-85	85cm	52.5	8550	9210	9210	8550
	5560-2B-113	113cm	70	11400	12280	12280	11400
	5560-2B-141	141cm	87.5	14250	15350	15350	14250
	5560-2B-169	169cm	105	17100	18420	18420	17100
	5560-2B-197	197cm	122.5	19950	21490	21490	19950
	5560-2B-225	225cm	140	22800	24560	24560	22800
	5560-2B-253	253cm	157.5	25650	27630	27630	25650
	5560-2B-281	281cm	175	28500	30700	30700	28500
	5560-2B-309	309cm	192.5	31350	33770	33770	31350
	5560-2B-337	337cm	210	34200	36840	36840	34200
	5560-2B-365	365cm	227.5	37050	39910	39910	37050
	5560-2B-393	393cm	245	39900	42980	42980	39900
	5560-2B-421	421cm	262.5	42750	46050	46050	42750
	5560-2B-449	449cm	280	45600	49120	49120	45600

wattage: 60.5 W/m

Το φωτιστικό είναι διαθέσιμο σε μήκος πολλαπλάσιο των 14 εκατοστών

The illuminant is available in lengths that are multiples of 14 centimeters.





SURFACE MOUNTED

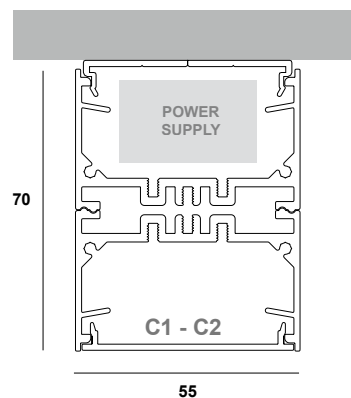

5570 - XX - XXX - X - XX - XX - X



<b>(a)</b>	<b>(b)</b>	<b>(c)</b>	<b>(d)</b>	<b>(e)</b>	<b>(f)</b>	<b>(g)</b>
Κωδικός Γραμμικού Linear Code	Κατηγορία Category	Μήκος Length	Θερμοκρασία φωτός Color Temperature	Χρώμα προφίλ Profile color	Κάλυμμα Cover	Αυξομείωση έντασης φωτός Dimming

**Παράδειγμα κωδικού / Code example**

LINEAR 55×70 87cm 1A 3000K Black with Diffuser Dimmable

SKU: 5570-1A-87-3-BL-C1-D

material	pcb details	CRI	lumen output / W
Extruded aluminium	Zhaga-Compliant Dimensions	Ra>80 ( <b>Ra&gt;90</b> on request)	up to 195 Lm/W

covers	profile color	CCT	dimming options (D)
Acrylic Diffuser (-C1-) 	Anodised ( <b>AN</b> )	3000K ( <b>3</b> )	Push
	Black ( <b>BL</b> )	4000K ( <b>4</b> )	DALI
	White ( <b>WH</b> )	5000K ( <b>5</b> )	TRIAC 0/1-10V
Acrylic Microprismatic (-C2-) 	RAL ( <b>RL</b> )	6500K ( <b>6</b> )	CASAMBI
		TUNABLE 2700K - 6500K ( <b>TN</b> )	Analog 0/1-10V

## LINEAR 55×70 / Lumen output tables

CATEGORY 1A 350mA (1A)	code	length	watt	lumens 3000K	lumens 4000K	lumens 5000K	lumens 6500K
	5570-1A-57	57cm	7.8	1390	1470	1470	1440
	5570-1A-85	85cm	11.7	2085	2205	2205	2160
	5570-1A-113	113cm	15.6	2780	2940	2940	2880
	5570-1A-141	141cm	19.5	3475	3675	3675	3600
	5570-1A-169	169cm	23.4	4170	4410	4410	4320
	5570-1A-197	197cm	27.3	4865	5145	5145	5040
	5570-1A-225	225cm	31.2	5560	5880	5880	5760
	5570-1A-253	253cm	35.1	6255	6615	6615	6480
	5570-1A-281	281cm	39	6950	7350	7350	7200
	5570-1A-309	309cm	42.9	7645	8085	8085	7920
	5570-1A-337	337cm	46.8	8340	8820	8820	8640
	5570-1A-365	365cm	50.7	9035	9555	9555	9360
	5570-1A-393	393cm	54.6	9730	10290	10290	10080
	5570-1A-421	421cm	58.5	10425	11025	11025	10800
5570-1A-449	449cm	62.4	11120	11760	11760	11520	

wattage: 13.5 W/m

5570-1B-57	57cm	11.6	1960	2070	2070	2020
5570-1B-85	85cm	17.4	2940	3105	3105	3030
5570-1B-113	113cm	23.2	3920	4140	4140	4040
5570-1B-141	141cm	29	4900	5175	5175	5050
5570-1B-169	169cm	34.8	5880	6210	6210	6060
5570-1B-197	197cm	40.6	6860	7245	7245	7070
5570-1B-225	225cm	46.4	7840	8280	8280	8080
5570-1B-253	253cm	52.2	8820	9315	9315	9090
5570-1B-281	281cm	58	9800	10350	10350	10100
5570-1B-309	309cm	63.8	10780	11385	11385	11110
5570-1B-337	337cm	69.6	11760	12420	12420	12120
5570-1B-365	365cm	75.4	12740	13455	13455	13130
5570-1B-393	393cm	81.2	13720	14490	14490	14140
5570-1B-421	421cm	87	14700	15525	15525	15150
5570-1B-449	449cm	92.8	15680	16560	16560	16160

wattage: 20 W/m

Το φωτιστικό είναι διαθέσιμο σε μήκος πολλαπλάσιο των 14 εκατοστών

The illuminant is available in lengths that are multiples of 14 centimeters.



## LINEAR 55×70 / Lumen output tables

	code	length	watt	lumens 3000K	lumens 4000K	lumens 5000K	lumens 6500K
CATEGORY 2A 350mA (2A)	5570-2A-57	57cm	23.6	4080	4380	4380	4080
	5570-2A-85	85cm	35.4	6120	6570	6570	6120
	5570-2A-113	113cm	47.2	8160	8760	8760	8160
	5570-2A-141	141cm	59	10200	10950	10950	10200
	5570-2A-169	169cm	70.8	12240	13140	13140	12240
	5570-2A-197	197cm	82.6	14280	15330	15330	14280
	5570-2A-225	225cm	94.4	16320	17520	17520	16320
	5570-2A-253	253cm	106.2	18360	19710	19710	18360
	5570-2A-281	281cm	118	20400	21900	21900	20400
	5570-2A-309	309cm	129.8	22440	24090	24090	22440
	5570-2A-337	337cm	141.6	24480	26280	26280	24480
	5570-2A-365	365cm	153.4	26520	28470	28470	26520
	5570-2A-393	393cm	165.2	28560	30660	30660	28560
	5570-2A-421	421cm	177	30600	32850	32850	30600
	5570-2A-449	449cm	188.8	32640	35040	35040	32640

wattage: 40.5 W/m

CATEGORY 2B 500mA (2B)	5570-2B-57	57cm	35	5700	6140	6140	5700
	5570-2B-85	85cm	52.5	8550	9210	9210	8550
	5570-2B-113	113cm	70	11400	12280	12280	11400
	5570-2B-141	141cm	87.5	14250	15350	15350	14250
	5570-2B-169	169cm	105	17100	18420	18420	17100
	5570-2B-197	197cm	122.5	19950	21490	21490	19950
	5570-2B-225	225cm	140	22800	24560	24560	22800
	5570-2B-253	253cm	157.5	25650	27630	27630	25650
	5570-2B-281	281cm	175	28500	30700	30700	28500
	5570-2B-309	309cm	192.5	31350	33770	33770	31350
	5570-2B-337	337cm	210	34200	36840	36840	34200
	5570-2B-365	365cm	227.5	37050	39910	39910	37050
	5570-2B-393	393cm	245	39900	42980	42980	39900
	5570-2B-421	421cm	262.5	42750	46050	46050	42750
	5570-2B-449	449cm	280	45600	49120	49120	45600

wattage: 60.5 W/m

Το φωτιστικό είναι διαθέσιμο σε μήκος πολλαπλάσιο των 14 εκατοστών

The illuminant is available in lengths that are multiples of 14 centimeters.

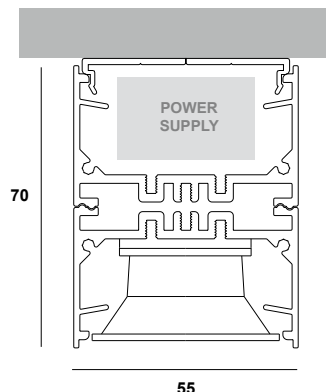

D5570 - XX - XXX - X - XXX - XX - X - X

(a)	(b)	(c)	(d)	(e)	(f)	(g)	(h)
Κωδικός Γραμμικού Linear Code	Κατηγορία Category	Μήκος Length	Θερμοκρασία φωτός Color Temperature	Γωνία Δέσμης Beam Angle	Χρώμα προφίλ Profile Color	Χρώμα Ρεφλέκτορα Reflector Color	Αυξομείωση έντασης φωτός Dimming

Παράδειγμα κωδικού / Code example

DARK LINEAR 55×70 1A 84.5cm 3000K 65D Black with Black Reflector Dimmable

SKU: D5570-1A-85-3-60D-BL-1-D

material	pcb details	CRI	lumen output / W
Extruded aluminium / Plastic	SMD light & dark 7×1	Ra>90 (Ra>80 on request)	up to 205 Lm/W

CCT	beam angle	profile color	reflector color	dimming options (D)
3000K (3)	Medium 65D (60D)	Anodised (AN)	Black (1)	Push
4000K (4)	Wide 90D (90D)	Black (BL)	White (2)	DALI
5000K (5)		White (WH)		TRIAC 0/1-10V
6500K (6)		RAL (RL)	CASAMBI	
TUNABLE 2700K - 6500K (TN)				Analog 0/1-10V

## DARK LINEAR 55×70 / Lumen output tables

CATEGORY 1A 350mA (1A)	code	length	watt	lumens 3000K (65D)	lumens 3000K (90D)	lumens 4000K (65D)	lumens 4000K (90D)
	D5570-1A-56.5	56.5cm	13.4	1702	1680	1774	1752
	D5570-1A-84.5	84.5cm	20.1	2553	2520	2661	2628
	D5570-1A-112.5	112.5cm	26.8	3404	3360	3548	3504
	D5570-1A-140.5	140.5cm	33.5	4255	4200	4435	4380
	D5570-1A-168.5	168.5cm	40.2	5106	5040	5322	5256
	D5570-1A-196.5	196.5cm	46.9	5957	5880	6209	6132
	D5570-1A-224.5	224.5cm	53.6	6808	6720	7096	7008
	D5570-1A-252.5	252.5cm	60.3	7659	7560	7983	7884
	D5570-1A-280.5	280.5cm	67	8510	8400	8870	8760
	D5570-1A-308.5	308.5cm	73.7	9361	9240	9757	9636
	D5570-1A-336.5	336.5cm	80.4	10212	10080	10644	10512
	D5570-1A-364.5	364.5cm	87.1	11063	10920	11531	11388
	D5570-1A-392.5	392.5cm	93.8	11914	11760	12418	12264
	D5570-1A-420.5	420.5cm	100.5	12765	12600	13305	13140
D5570-1A-448.5	448.5cm	107.2	13616	13440	14192	14016	

wattage: 23 W/m

CATEGORY 1B 500mA (1B)	D5570-1B-56.5	56.5cm	19.8	2398	2368	2512	2480
	D5570-1B-84.5	84.5cm	29.7	3597	3552	3768	3720
	D5570-1B-112.5	112.5cm	39.6	4796	4736	5024	4960
	D5570-1B-140.5	140.5cm	49.5	5995	5920	6280	6200
	D5570-1B-168.5	168.5cm	59.4	7194	7104	7536	7440
	D5570-1B-196.5	196.5cm	69.3	8393	8288	8792	8680
	D5570-1B-224.5	224.5cm	79.2	9592	9472	10048	9920
	D5570-1B-252.5	252.5cm	89.1	10791	10656	11304	11160
	D5570-1B-280.5	280.5cm	99	11990	11840	12560	12400
	D5570-1B-308.5	308.5cm	108.9	13189	13024	13816	13640
	D5570-1B-336.5	336.5cm	118.8	14388	14208	15072	14880
	D5570-1B-364.5	364.5cm	128.7	15587	15392	16328	16120
	D5570-1B-392.5	392.5cm	138.6	16786	16576	17584	17360
	D5570-1B-420.5	420.5cm	148.5	17985	17760	18840	18600
	D5570-1B-448.5	448.5cm	158.4	19184	18944	20096	19840

wattage: 34 W/m

Το φωτιστικό είναι διαθέσιμο σε μήκος πολλαπλάσιο των 28 εκατοστών

The illuminant is available in lengths that are multiples of 28 centimeters.



SURFACE MOUNTED



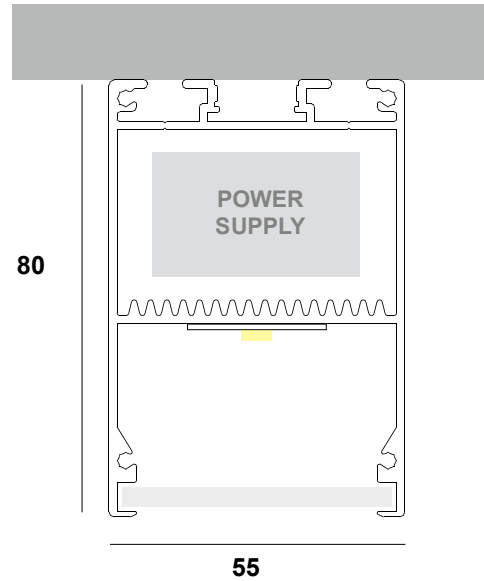

5580 - XX - XXX - X - XX - XX - X

(a)	(b)	(c)	(d)	(e)	(f)	(g)
Κωδικός Γραμμικού Linear Code	Κατηγορία Category	Μήκος Length	Θερμοκρασία φωτός Color Temperature	Χρώμα προφίλ Profile color	Κάλυμμα Cover	Αυξομείωση έντασης φωτός Dimming

**Παράδειγμα κωδικού / Code example**

NILE 55×80 88cm 1A 3000K Black with Diffuser Dimmable  
**SKU:** 5580-1A-88-3-BL-C1-D

material	pcb details	CRI	lumen output / W
Extruded aluminium	Zhaga-Compliant Dimensions	Ra>80 ( <b>Ra&gt;90</b> on request)	up to 195 Lm/W

covers	profile color	CCT	dimming options (D)
Acrylic Diffuser (-C1-)	Anodised ( <b>AN</b> )	3000K ( <b>3</b> )	Push
	Black ( <b>BL</b> )	4000K ( <b>4</b> )	DALI
	White ( <b>WH</b> )	5000K ( <b>5</b> )	TRIAC 0/1-10V
Acrylic Microprismatic (-C2-)	RAL ( <b>RL</b> )	6500K ( <b>6</b> )	CASAMBI
		TUNABLE 2700K - 6500K ( <b>TN</b> )	Analog 0/1-10V

## NILE 55×80 / Lumen output tables

CATEGORY 1A 350mA (1A)	code	length	watt	lumens 3000K	lumens 4000K	lumens 5000K	lumens 6500K
	5580-1A-60	60cm	7.8	1390	1470	1470	1440
	5580-1A-88	88cm	11.7	2085	2205	2205	2160
	5580-1A-116	116cm	15.6	2780	2940	2940	2880
	5580-1A-144	144cm	19.5	3475	3675	3675	3600
	5580-1A-172	172cm	23.4	4170	4410	4410	4320
	5580-1A-200	200cm	27.3	4865	5145	5145	5040
	5580-1A-228	228cm	31.2	5560	5880	5880	5760
	5580-1A-256	256cm	35.1	6255	6615	6615	6480
	5580-1A-284	284cm	39	6950	7350	7350	7200
	5580-1A-312	312cm	42.9	7645	8085	8085	7920
	5580-1A-340	340cm	46.8	8340	8820	8820	8640
	5580-1A-368	368cm	50.7	9035	9555	9555	9360
	5580-1A-396	396cm	54.6	9730	10290	10290	10080
	5580-1A-424	424cm	58.5	10425	11025	11025	10800
5580-1A-452	452cm	62.4	11120	11760	11760	11520	

wattage: 13.5 W/m

5580-1B-60	60cm	11.6	1960	2070	2070	2020
5580-1B-88	88cm	17.4	2940	3105	3105	3030
5580-1B-116	116cm	23.2	3920	4140	4140	4040
5580-1B-144	144cm	29	4900	5175	5175	5050
5580-1B-172	172cm	34.8	5880	6210	6210	6060
5580-1B-200	200cm	40.6	6860	7245	7245	7070
5580-1B-228	228cm	46.4	7840	8280	8280	8080
5580-1B-256	256cm	52.2	8820	9315	9315	9090
5580-1B-284	284cm	58	9800	10350	10350	10100
5580-1B-312	312cm	63.8	10780	11385	11385	11110
5580-1B-340	340cm	69.6	11760	12420	12420	12120
5580-1B-368	368cm	75.4	12740	13455	13455	13130
5580-1B-396	396cm	81.2	13720	14490	14490	14140
5580-1B-424	424cm	87	14700	15525	15525	15150
5580-1B-452	452cm	92.8	15680	16560	16560	16160

wattage: 20 W/m

Το φωτιστικό είναι διαθέσιμο σε μήκος πολλαπλάσιο των 14 εκατοστών

The illuminant is available in lengths that are multiples of 14 centimeters.

## NILE 55×80 / Lumen output tables

CATEGORY 2A 350mA (2A)	code	length	watt	lumens 3000K	lumens 4000K	lumens 5000K	lumens 6500K
	5580-2A-60	60cm	23.6	4080	4380	4380	4080
	5580-2A-88	88cm	35.4	6120	6570	6570	6120
	5580-2A-116	116cm	47.2	8160	8760	8760	8160
	5580-2A-144	144cm	59	10200	10950	10950	10200
	5580-2A-172	172cm	70.8	12240	13140	13140	12240
	5580-2A-200	200cm	82.6	14280	15330	15330	14280
	5580-2A-228	228cm	94.4	16320	17520	17520	16320
	5580-2A-256	256cm	106.2	18360	19710	19710	18360
	5580-2A-284	284cm	118	20400	21900	21900	20400
	5580-2A-312	312cm	129.8	22440	24090	24090	22440
	5580-2A-340	340cm	141.6	24480	26280	26280	24480
	5580-2A-368	368cm	153.4	26520	28470	28470	26520
	5580-2A-396	396cm	165.2	28560	30660	30660	28560
	5580-2A-424	424cm	177	30600	32850	32850	30600
5580-2A-452	452cm	188.8	32640	35040	35040	32640	

wattage: 40.5 W/m

5580-2B-60	60cm	35	5700	6140	6140	5700
5580-2B-88	88cm	52.5	8550	9210	9210	8550
5580-2B-116	116cm	70	11400	12280	12280	11400
5580-2B-144	144cm	87.5	14250	15350	15350	14250
5580-2B-172	172cm	105	17100	18420	18420	17100
5580-2B-200	200cm	122.5	19950	21490	21490	19950
5580-2B-228	228cm	140	22800	24560	24560	22800
5580-2B-256	256cm	157.5	25650	27630	27630	25650
5580-2B-284	284cm	175	28500	30700	30700	28500
5580-2B-312	312cm	192.5	31350	33770	33770	31350
5580-2B-340	340cm	210	34200	36840	36840	34200
5580-2B-368	368cm	227.5	37050	39910	39910	37050
5580-2B-396	396cm	245	39900	42980	42980	39900
5580-2B-424	424cm	262.5	42750	46050	46050	42750
5580-2B-452	452cm	280	45600	49120	49120	45600

wattage: 60.5 W/m

Το φωτιστικό είναι διαθέσιμο σε μήκος πολλαπλάσιο των 14 εκατοστών

The illuminant is available in lengths that are multiples of 14 centimeters.



SURFACE MOUNTED

ΚΡΕΜΑΣΤΑ / SUSPENDED

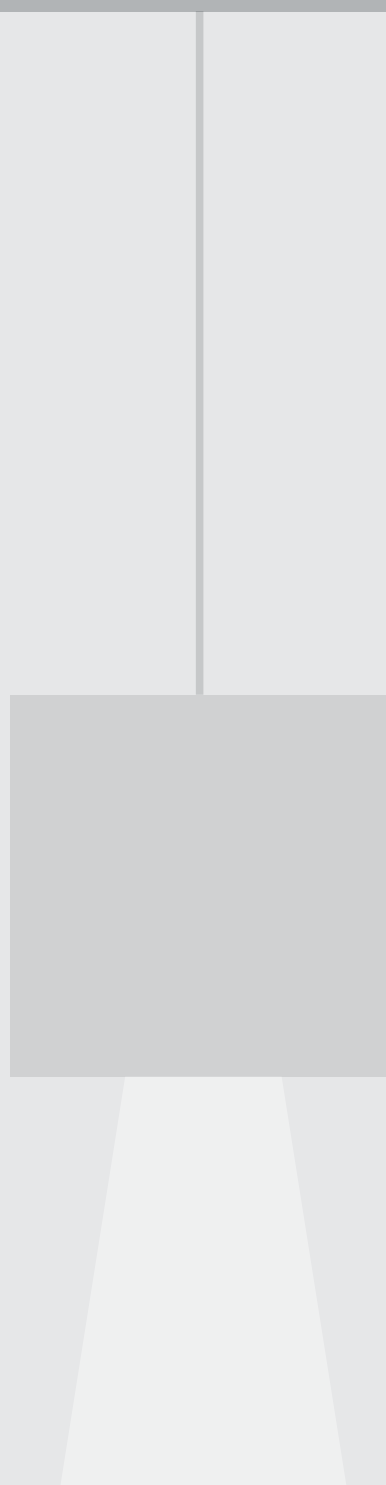

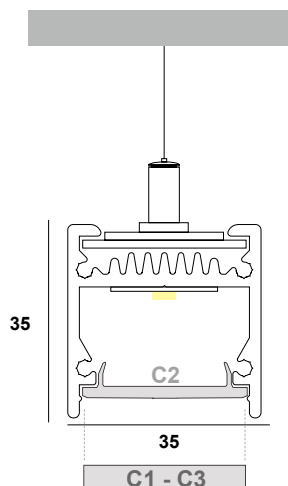

S35 - XX - XXX - X - XX - XX - X - XXX

(a)	(b)	(c)	(d)	(e)	(f)	(g)	(h)
Κωδικός Γραμμικού Linear Code	Κατηγορία Category	Μήκος Length	Θερμοκρασία φωτός Color Temperature	Χρώμα προφίλ Profile color	Κάλυμμα Cover	Αυξομείωση έντασης φωτός Dimming	Τοποθέτηση τροφοδοτικού Power supply installation

Παράδειγμα κωδικού / Code example

GILA 35×35 SUSPENDED 87cm 1A 3000K Black Dimmable with Slide Diffuser 1.5mm (Hidden power supply)  
SKU: S35-1A-87-3-C2-D-PS2

material	pcb details	CRI	lumen output / W
Extruded aluminium	Zhaga-Compliant Dimensions	Ra>80 (Ra>90 on request)	up to 195 Lm/W

covers	profile color	CCT	dimming options (D)
Slide Diffuser 5mm (-C1-)	Anodised (AN)	3000K (3)	Push
	Black (BL)	4000K (4)	DALI
	White (WH)	5000K (5)	TRIAC 0/1-10V
Click diffuser 1.5mm (up to 70m reel) (-C2-)	RAL (RL)	6500K (6)	CASAMBI
		TUNABLE 2700K - 6500K (TN)	Analog 0/1-10V
Microprismatic (-C3-)			

power supply installation	
Σε ροζέτα στην οροφή In rosette on the ceiling (-PS1-)	Κρυφό με πρόσβαση στο τροφοδοτικό Hidden with access to the power supply (-PS2-)





SUSPENDED



## GILA 35×35 SUSPENDED / Lumen output tables

	code	length	watt	lumens 3000K	lumens 4000K	lumens 5000K	lumens 6500K
CATEGORY 1A 350mA (1A)	S35-1A-59	59cm	7.8	1390	1470	1470	1440
	S35-1A-87	87cm	11.7	2085	2205	2205	2160
	S35-1A-115	115cm	15.6	2780	2940	2940	2880
	S35-1A-143	143cm	19.5	3475	3675	3675	3600
	S35-1A-171	171cm	23.4	4170	4410	4410	4320
	S35-1A-199	199cm	27.3	4865	5145	5145	5040
	S35-1A-227	227cm	31.2	5560	5880	5880	5760
	S35-1A-255	255cm	35.1	6255	6615	6615	6480
	S35-1A-283	283cm	39	6950	7350	7350	7200
	S35-1A-311	311cm	42.9	7645	8085	8085	7920
	S35-1A-339	339cm	46.8	8340	8820	8820	8640
	S35-1A-367	367cm	50.7	9035	9555	9555	9360
	S35-1A-395	395cm	54.6	9730	10290	10290	10080
	S35-1A-423	423cm	58.5	10425	11025	11025	10800
	S35-1A-451	451cm	62.4	11120	11760	11760	11520

wattage: 13.5 W/m

CATEGORY 1B 500mA (1B)	S35-1B-59	59cm	11.6	1960	2070	2070	2020
	S35-1B-87	87cm	17.4	2940	3105	3105	3030
	S35-1B-115	115cm	23.2	3920	4140	4140	4040
	S35-1B-143	143cm	29	4900	5175	5175	5050
	S35-1B-171	171cm	34.8	5880	6210	6210	6060
	S35-1B-199	199cm	40.6	6860	7245	7245	7070
	S35-1B-227	227cm	46.4	7840	8280	8280	8080
	S35-1B-255	255cm	52.2	8820	9315	9315	9090
	S35-1B-283	283cm	58	9800	10350	10350	10100
	S35-1B-311	311cm	63.8	10780	11385	11385	11110
	S35-1B-339	339cm	69.6	11760	12420	12420	12120
	S35-1B-367	367cm	75.4	12740	13455	13455	13130
	S35-1B-395	395cm	81.2	13720	14490	14490	14140
	S35-1B-423	423cm	87	14700	15525	15525	15150
	S35-1B-451	451cm	92.8	15680	16560	16560	16160

wattage: 20 W/m

Το φωτιστικό είναι διαθέσιμο σε μήκος πολλαπλάσιο των 14 εκατοστών

The illuminant is available in lengths that are multiples of 14 centimeters.

## GILA 35×35 SUSPENDED / Lumen output tables

CATEGORY 2A 350mA (2A)	code	length	watt	lumens 3000K	lumens 4000K	lumens 5000K	lumens 6500K
	S35-2A-59	59cm	23.6	4080	4380	4380	4080
	S35-2A-87	87cm	35.4	6120	6570	6570	6120
	S35-2A-115	115cm	47.2	8160	8760	8760	8160
	S35-2A-143	143cm	59	10200	10950	10950	10200
	S35-2A-171	171cm	70.8	12240	13140	13140	12240
	S35-2A-199	199cm	82.6	14280	15330	15330	14280
	S35-2A-227	227cm	94.4	16320	17520	17520	16320
	S35-2A-255	255cm	106.2	18360	19710	19710	18360
	S35-2A-283	283cm	118	20400	21900	21900	20400
	S35-2A-311	311cm	129.8	22440	24090	24090	22440
	S35-2A-339	339cm	141.6	24480	26280	26280	24480
	S35-2A-367	367cm	153.4	26520	28470	28470	26520
	S35-2A-395	395cm	165.2	28560	30660	30660	28560
	S35-2A-423	423cm	177	30600	32850	32850	30600
S35-2A-451	451cm	188.8	32640	35040	35040	32640	

wattage: 40.5 W/m

S35-2B-59	59cm	35	5700	6140	6140	5700
S35-2B-87	87cm	52.5	8550	9210	9210	8550
S35-2B-115	115cm	70	11400	12280	12280	11400
S35-2B-143	143cm	87.5	14250	15350	15350	14250
S35-2B-171	171cm	105	17100	18420	18420	17100
S35-2B-199	199cm	122.5	19950	21490	21490	19950
S35-2B-227	227cm	140	22800	24560	24560	22800
S35-2B-255	255cm	157.5	25650	27630	27630	25650
S35-2B-283	283cm	175	28500	30700	30700	28500
S35-2B-311	311cm	192.5	31350	33770	33770	31350
S35-2B-339	339cm	210	34200	36840	36840	34200
S35-2B-367	367cm	227.5	37050	39910	39910	37050
S35-2B-395	395cm	245	39900	42980	42980	39900
S35-2B-423	423cm	262.5	42750	46050	46050	42750
S35-2B-451	451cm	280	45600	49120	49120	45600

wattage: 60.5 W/m

Το φωτιστικό είναι διαθέσιμο σε μήκος πολλαπλάσιο των 14 εκατοστών

The illuminant is available in lengths that are multiples of 14 centimeters.

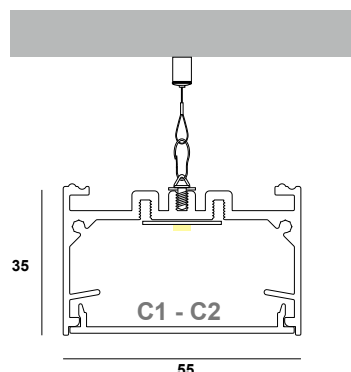

# S5535 - XX - XXX - X - XX - XX - X



- (a)**  
Κωδικός Γραμμικού  
Linear Code
- (b)**  
Κατηγορία  
Category
- (c)**  
Μήκος  
Length
- (d)**  
Θερμοκρασία  
φωτός  
Color  
Temperature
- (e)**  
Χρώμα  
προφίλ  
Profile  
color
- (f)**  
Κάλυμμα  
Cover
- (g)**  
Αυξομείωση  
έντασης φωτός  
Dimming

**Παράδειγμα κωδικού / Code example**

LENA 55×35 SUSPENDED 85cm 1A 3000K Black with Diffuser Dimmable (Hidden power supply)

SKU: S5535-1A-85-3-BL-C1-D-PS3

material	pcb details	CRI	lumen output / W
Extruded aluminium	Zhaga-Compliant Dimensions	Ra>80 (Ra>90 on request)	up to 195 Lm/W

covers	profile color	CCT	dimming options (D)
Acrylic Diffuser (-C1-) 	Anodised (AN)	3000K (3)	Push
	Black (BL)	4000K (4)	DALI
	White (WH)	5000K (5)	TRIAC 0/1-10V
Acrylic Microprismatic (-C2-) 	RAL (RL)	6500K (6)	CASAMBI
		TUNABLE 2700K - 6500K (TN)	Analog 0/1-10V

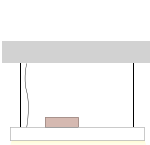
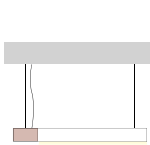
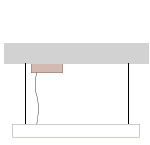
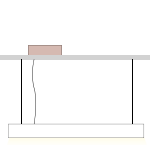
power supply installation			
 <p>Πάνω στο προφίλ με ροζέτα On the profile with rosette</p> <p><b>(-PS1-)</b></p>	 <p>Δίπλα στο προφίλ με ροζέτα To the side of the profile with rosette</p> <p><b>(-PS2-)</b></p>	 <p>Σε ροζέτα στην οροφή In rosette on the ceiling</p> <p><b>(-PS3-)</b></p>	 <p>Κρυφό με πρόσβαση στο τροφοδοτικό Hidden with access to the power supply</p> <p><b>(-PS4-)</b></p>



SUSPENDED

## LENA 55×35 SUSPENDED / Lumen output tables

	code	length	watt	lumens 3000K	lumens 4000K	lumens 5000K	lumens 6500K
CATEGORY 1A 350mA (1A)	S5535-1A-57	57cm	7.8	1390	1470	1470	1440
	S5535-1A-85	85cm	11.7	2085	2205	2205	2160
	S5535-1A-113	113cm	15.6	2780	2940	2940	2880
	S5535-1A-141	141cm	19.5	3475	3675	3675	3600
	S5535-1A-169	169cm	23.4	4170	4410	4410	4320
	S5535-1A-197	197cm	27.3	4865	5145	5145	5040
	S5535-1A-225	225cm	31.2	5560	5880	5880	5760
	S5535-1A-253	253cm	35.1	6255	6615	6615	6480
	S5535-1A-281	281cm	39	6950	7350	7350	7200
	S5535-1A-309	309cm	42.9	7645	8085	8085	7920
	S5535-1A-337	337cm	46.8	8340	8820	8820	8640
	S5535-1A-365	365cm	50.7	9035	9555	9555	9360
	S5535-1A-393	393cm	54.6	9730	10290	10290	10080
	S5535-1A-421	421cm	58.5	10425	11025	11025	10800
	S5535-1A-449	449cm	62.4	11120	11760	11760	11520

wattage: 13.5 W/m

CATEGORY 1B 500mA (1B)	S5535-1B-57	57cm	11.6	1960	2070	2070	2020
	S5535-1B-85	85cm	17.4	2940	3105	3105	3030
	S5535-1B-113	113cm	23.2	3920	4140	4140	4040
	S5535-1B-141	141cm	29	4900	5175	5175	5050
	S5535-1B-169	169cm	34.8	5880	6210	6210	6060
	S5535-1B-197	197cm	40.6	6860	7245	7245	7070
	S5535-1B-225	225cm	46.4	7840	8280	8280	8080
	S5535-1B-253	253cm	52.2	8820	9315	9315	9090
	S5535-1B-281	281cm	58	9800	10350	10350	10100
	S5535-1B-309	309cm	63.8	10780	11385	11385	11110
	S5535-1B-337	337cm	69.6	11760	12420	12420	12120
	S5535-1B-365	365cm	75.4	12740	13455	13455	13130
	S5535-1B-393	393cm	81.2	13720	14490	14490	14140
	S5535-1B-421	421cm	87	14700	15525	15525	15150
	S5535-1B-449	449cm	92.8	15680	16560	16560	16160

wattage: 20 W/m

Το φωτιστικό είναι διαθέσιμο σε μήκος πολλαπλάσιο των 14 εκατοστών

The illuminant is available in lengths that are multiples of 14 centimeters.

## LENA 55×35 SUSPENDED / Lumen output tables

CATEGORY 2A 350mA (2A)	code	length	watt	lumens 3000K	lumens 4000K	lumens 5000K	lumens 6500K
	S5535-2A-57	57cm	23.6	4080	4380	4380	4080
	S5535-2A-85	85cm	35.4	6120	6570	6570	6120
	S5535-2A-113	113cm	47.2	8160	8760	8760	8160
	S5535-2A-141	141cm	59	10200	10950	10950	10200
	S5535-2A-169	169cm	70.8	12240	13140	13140	12240
	S5535-2A-197	197cm	82.6	14280	15330	15330	14280
	S5535-2A-225	225cm	94.4	16320	17520	17520	16320
	S5535-2A-253	253cm	106.2	18360	19710	19710	18360
	S5535-2A-281	281cm	118	20400	21900	21900	20400
	S5535-2A-309	309cm	129.8	22440	24090	24090	22440
	S5535-2A-337	337cm	141.6	24480	26280	26280	24480
	S5535-2A-365	365cm	153.4	26520	28470	28470	26520
	S5535-2A-393	393cm	165.2	28560	30660	30660	28560
	S5535-2A-421	421cm	177	30600	32850	32850	30600
S5535-2A-449	449cm	188.8	32640	35040	35040	32640	

wattage: 40.5 W/m

S5535-2B-57	57cm	35	5700	6140	6140	5700
S5535-2B-85	85cm	52.5	8550	9210	9210	8550
S5535-2B-113	113cm	70	11400	12280	12280	11400
S5535-2B-141	141cm	87.5	14250	15350	15350	14250
S5535-2B-169	169cm	105	17100	18420	18420	17100
S5535-2B-197	197cm	122.5	19950	21490	21490	19950
S5535-2B-225	225cm	140	22800	24560	24560	22800
S5535-2B-253	253cm	157.5	25650	27630	27630	25650
S5535-2B-281	281cm	175	28500	30700	30700	28500
S5535-2B-309	309cm	192.5	31350	33770	33770	31350
S5535-2B-337	337cm	210	34200	36840	36840	34200
S5535-2B-365	365cm	227.5	37050	39910	39910	37050
S5535-2B-393	393cm	245	39900	42980	42980	39900
S5535-2B-421	421cm	262.5	42750	46050	46050	42750
S5535-2B-449	449cm	280	45600	49120	49120	45600

wattage: 60.5 W/m

Το φωτιστικό είναι διαθέσιμο σε μήκος πολλαπλάσιο των 14 εκατοστών  
 The illuminant is available in lengths that are multiples of 14 centimeters.

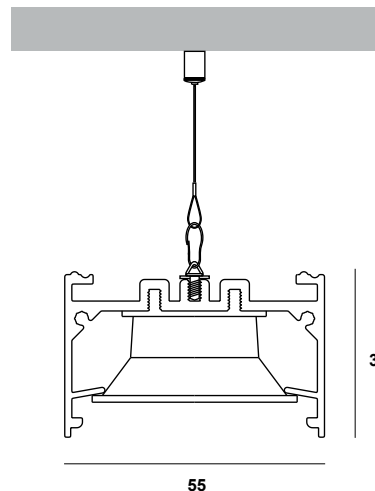

# SD5535 - XX - XXX - X - XXX - XX - X - X - XXX

(a)	(b)	(c)	(d)	(e)	(f)	(g)	(h)	(i)
Κωδικός Γραμμικού Linear Code	Κατηγορία Category	Μήκος Length	Θερμοκρασία φωτός Color Temperature	Γωνία Δέσμης Beam Angle	Χρώμα προφίλ Profile Color	Χρώμα Ρεφλέκτορα Reflector Color	Αυξομείωση έντασης φωτός Dimming	Τοποθέτηση τροφοδοτικού Power supply installation

## Παράδειγμα κωδικού / Code example

DARK LENA 55×35 SUSPENDED 1A 84.5cm 3000K 65D Black with Black Reflector Dimmable (Hidden power supply)  
**SKU:** SD5535-1A-85-3-60D-BL-1-D-PS3

material	pcb details	CRI	lumen output / W
Extruded aluminium / Plastic	SMD light & dark 7×1	Ra>90 (Ra>80 on request)	up to 205 Lm/W

CCT	beam angle	profile color	reflector color	dimming options (D)
3000K (3)	Medium 65D (60D)	Anodised (AN)	Black (1)	Push
4000K (4)	Wide 90D (90D)	Black (BL)	White (2)	DALI
5000K (5)		White (WH)		TRIAC 0/1-10V
6500K (6)		RAL (RL)		CASAMBI
TUNABLE 2700K - 6500K (TN)				Analog 0/1-10V

power supply installation			
<p>Πάνω στο προφίλ με ροζέτα On the profile with rosette</p> <p>(-PS1-)</p>	<p>Δίπλα στο προφίλ με ροζέτα To the side of the profile with rosette</p> <p>(-PS2-)</p>	<p>Σε ροζέτα στην οροφή In rosette on the ceiling</p> <p>(-PS3-)</p>	<p>Κρυφό με πρόσβαση στο τροφοδοτικό Hidden with access to the power supply</p> <p>(-PS4-)</p>



## DARK LENA 55×35 SUSPENDED / Lumen output tables

CATEGORY 1A 350mA (1A)	code	length	watt	lumens 3000K (65D)	lumens 3000K (90D)	lumens 4000K (65D)	lumens 4000K (90D)
	SD5535-1A-56.5	56.5cm	13.4	1702	1680	1774	1752
	SD5535-1A-84.5	84.5cm	20.1	2553	2520	2661	2628
	SD5535-1A-112.5	112.5cm	26.8	3404	3360	3548	3504
	SD5535-1A-140.5	140.5cm	33.5	4255	4200	4435	4380
	SD5535-1A-168.5	168.5cm	40.2	5106	5040	5322	5256
	SD5535-1A-196.5	196.5cm	46.9	5957	5880	6209	6132
	SD5535-1A-224.5	224.5cm	53.6	6808	6720	7096	7008
	SD5535-1A-252.5	252.5cm	60.3	7659	7560	7983	7884
	SD5535-1A-280.5	280.5cm	67	8510	8400	8870	8760
	SD5535-1A-308.5	308.5cm	73.7	9361	9240	9757	9636
	SD5535-1A-36.5	336.5cm	80.4	10212	10080	10644	10512
	SD5535-1A-364.5	364.5cm	87.1	11063	10920	11531	11388
	SD5535-1A-392.5	392.5cm	93.8	11914	11760	12418	12264
	SD5535-1A-420.5	420.5cm	100.5	12765	12600	13305	13140
	SD5535-1A-448.5	448.5cm	107.2	13616	13440	14192	14016

wattage: 23 W/m

SD5535-1B-56.5	56.5cm	19.8	2398	2368	2512	2480
SD5535-1B-84.5	84.5cm	29.7	3597	3552	3768	3720
SD5535-1B-112.5	112.5cm	39.6	4796	4736	5024	4960
SD5535-1B-140.5	140.5cm	49.5	5995	5920	6280	6200
SD5535-1B-168.5	168.5cm	59.4	7194	7104	7536	7440
SD5535-1B-196.5	196.5cm	69.3	8393	8288	8792	8680
SD5535-1B-224.5	224.5cm	79.2	9592	9472	10048	9920
SD5535-1B-252.5	252.5cm	89.1	10791	10656	11304	11160
SD5535-1B-280.5	280.5cm	99	11990	11840	12560	12400
SD5535-1B-308.5	308.5cm	108.9	13189	13024	13816	13640
SD5535-1B-36.5	336.5cm	118.8	14388	14208	15072	14880
SD5535-1B-364.5	364.5cm	128.7	15587	15392	16328	16120
SD5535-1B-392.5	392.5cm	138.6	16786	16576	17584	17360
SD5535-1B-420.5	420.5cm	148.5	17985	17760	18840	18600
SD5535-1B-448.5	448.5cm	158.4	19184	18944	20096	19840

wattage: 34 W/m

Το φωτιστικό είναι διαθέσιμο σε μήκος πολλαπλάσιο των 28 εκατοστών

The illuminant is available in lengths that are multiples of 28 centimeters.

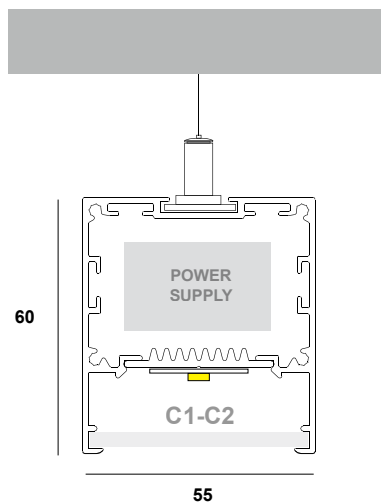

S5560 - XX - XXX - X - XX - XX - X

- (a)  
Κωδικός Γραμμικού  
Linear Code
- (b)  
Κατηγορία  
Category
- (c)  
Μήκος  
Length
- (d)  
Θερμοκρασία  
φωτός  
Color  
Temperature
- (e)  
Χρώμα  
Color
- (f)  
Κάλυμμα  
Cover
- (g)  
Αυξομείωση  
έντασης φωτός  
Dimming

Παράδειγμα κωδικού / Code example

GANGES 55×60 SUSPENDED 85cm 1A 3000K Black with Diffuser Dimmable  
 SKU: S5560-1A-85-3-BL-C1-D

material	pcb details	CRI	lumen output / W
Extruded aluminium	Zhaga-Compliant Dimensions	Ra>80 (Ra>90 on request)	up to 195 Lm/W

covers	profile color	CCT	dimming options (D)
Diffuser 3mm (-C1-)	Anodised (AN)	3000K (3)	Push
	Black (BL)	4000K (4)	DALI
	White (WH)	5000K (5)	TRIAC 0/1-10V
Microprismatic 3mm (-C2-)	RAL (RL)	6500K (6)	CASAMBI
		TUNABLE 2700K - 6500K (TN)	Analog 0/1-10V

## GANGES 55×60 SUSPENDED / Lumen output tables

CATEGORY 1A 350mA (1A)	code	length	watt	lumens 3000K	lumens 4000K	lumens 5000K	lumens 6500K
	S5560-1A-57	57cm	7.8	1390	1470	1470	1440
	S5560-1A-85	85cm	11.7	2085	2205	2205	2160
	S5560-1A-113	113cm	15.6	2780	2940	2940	2880
	S5560-1A-141	141cm	19.5	3475	3675	3675	3600
	S5560-1A-169	169cm	23.4	4170	4410	4410	4320
	S5560-1A-197	197cm	27.3	4865	5145	5145	5040
	S5560-1A-225	225cm	31.2	5560	5880	5880	5760
	S5560-1A-253	253cm	35.1	6255	6615	6615	6480
	S5560-1A-281	281cm	39	6950	7350	7350	7200
	S5560-1A-309	309cm	42.9	7645	8085	8085	7920
	S5560-1A-337	337cm	46.8	8340	8820	8820	8640
	S5560-1A-365	365cm	50.7	9035	9555	9555	9360
	S5560-1A-393	393cm	54.6	9730	10290	10290	10080
	S5560-1A-421	421cm	58.5	10425	11025	11025	10800
S5560-1A-449	449cm	62.4	11120	11760	11760	11520	

wattage: 13.5 W/m

S5560-1B-57	57cm	11.6	1960	2070	2070	2020
S5560-1B-85	85cm	17.4	2940	3105	3105	3030
S5560-1B-113	113cm	23.2	3920	4140	4140	4040
S5560-1B-141	141cm	29	4900	5175	5175	5050
S5560-1B-169	169cm	34.8	5880	6210	6210	6060
S5560-1B-197	197cm	40.6	6860	7245	7245	7070
S5560-1B-225	225cm	46.4	7840	8280	8280	8080
S5560-1B-253	253cm	52.2	8820	9315	9315	9090
S5560-1B-281	281cm	58	9800	10350	10350	10100
S5560-1B-309	309cm	63.8	10780	11385	11385	11110
S5560-1B-337	337cm	69.6	11760	12420	12420	12120
S5560-1B-365	365cm	75.4	12740	13455	13455	13130
S5560-1B-393	393cm	81.2	13720	14490	14490	14140
S5560-1B-421	421cm	87	14700	15525	15525	15150
S5560-1B-449	449cm	92.8	15680	16560	16560	16160

wattage: 20 W/m

Το φωτιστικό είναι διαθέσιμο σε μήκος πολλαπλάσιο των 14 εκατοστών

The illuminant is available in lengths that are multiples of 14 centimeters.

## GANGES 55×60 SUSPENDED / Lumen output tables

	code	length	watt	lumens 3000K	lumens 4000K	lumens 5000K	lumens 6500K
CATEGORY 2A 350mA (2A)	S5560-2A-57	57cm	23.6	4080	4380	4380	4080
	S5560-2A-85	85cm	35.4	6120	6570	6570	6120
	S5560-2A-113	113cm	47.2	8160	8760	8760	8160
	S5560-2A-141	141cm	59	10200	10950	10950	10200
	S5560-2A-169	169cm	70.8	12240	13140	13140	12240
	S5560-2A-197	197cm	82.6	14280	15330	15330	14280
	S5560-2A-225	225cm	94.4	16320	17520	17520	16320
	S5560-2A-253	253cm	106.2	18360	19710	19710	18360
	S5560-2A-281	281cm	118	20400	21900	21900	20400
	S5560-2A-309	309cm	129.8	22440	24090	24090	22440
	S5560-2A-337	337cm	141.6	24480	26280	26280	24480
	S5560-2A-365	365cm	153.4	26520	28470	28470	26520
	S5560-2A-393	393cm	165.2	28560	30660	30660	28560
	S5560-2A-421	421cm	177	30600	32850	32850	30600
	S5560-2A-449	449cm	188.8	32640	35040	35040	32640

wattage: 40.5 W/m

CATEGORY 2B 500mA (2B)	S5560-2B-57	57cm	35	5700	6140	6140	5700
	S5560-2B-85	85cm	52.5	8550	9210	9210	8550
	S5560-2B-113	113cm	70	11400	12280	12280	11400
	S5560-2B-141	141cm	87.5	14250	15350	15350	14250
	S5560-2B-169	169cm	105	17100	18420	18420	17100
	S5560-2B-197	197cm	122.5	19950	21490	21490	19950
	S5560-2B-225	225cm	140	22800	24560	24560	22800
	S5560-2B-253	253cm	157.5	25650	27630	27630	25650
	S5560-2B-281	281cm	175	28500	30700	30700	28500
	S5560-2B-309	309cm	192.5	31350	33770	33770	31350
	S5560-2B-337	337cm	210	34200	36840	36840	34200
	S5560-2B-365	365cm	227.5	37050	39910	39910	37050
	S5560-2B-393	393cm	245	39900	42980	42980	39900
	S5560-2B-421	421cm	262.5	42750	46050	46050	42750
	S5560-2B-449	449cm	280	45600	49120	49120	45600

wattage: 60.5 W/m

Το φωτιστικό είναι διαθέσιμο σε μήκος πολλαπλάσιο των 14 εκατοστών

The illuminant is available in lengths that are multiples of 14 centimeters.



SUSPENDED



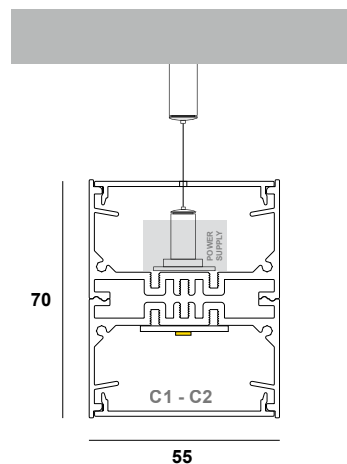

S5570 - XX - XXX - X - XX - XX - X

- (a)  
Κωδικός Γραμμικού  
Linear Code
- (b)  
Κατηγορία  
Category
- (c)  
Μήκος  
Length
- (d)  
Θερμοκρασία  
φωτός  
Color  
Temperature
- (e)  
Χρώμα  
προφίλ  
Profile  
color
- (f)  
Κάλυμμα  
Cover
- (g)  
Αυξομείωση  
έντασης φωτός  
Dimming

**Παράδειγμα κωδικού / Code example**

LINEAR 55×70 SUSPENDED 85cm 1A 3000K Black with Diffuser Dimmable  
 SKU: S5570-1A-85-3-BL-C1-D

material	pcb details	CRI	lumen output / W
Extruded aluminium	Zhaga-Compliant Dimensions	Ra>80 (Ra>90 on request)	up to 195 Lm/W

covers	profile color	CCT	dimming options (D)
Acrylic Diffuser (-C1-)	Anodised (AN)	3000K (3)	Push
	Black (BL)	4000K (4)	DALI
	White (WH)	5000K (5)	TRIAC 0/1-10V
Acrylic Microprismatic (-C2-)	RAL (RL)	6500K (6)	CASAMBI
		TUNABLE 2700K - 6500K (TN)	Analog 0/1-10V

## LINEAR 55×70 SUSPENDED / Lumen output tables

CATEGORY 1A 350mA (1A)	code	length	watt	lumens 3000K	lumens 4000K	lumens 5000K	lumens 6500K
	S5570-1A-57	57cm	7.8	1390	1470	1470	1440
	S5570-1A-85	85cm	11.7	2085	2205	2205	2160
	S5570-1A-113	113cm	15.6	2780	2940	2940	2880
	S5570-1A-141	141cm	19.5	3475	3675	3675	3600
	S5570-1A-169	169cm	23.4	4170	4410	4410	4320
	S5570-1A-197	197cm	27.3	4865	5145	5145	5040
	S5570-1A-225	225cm	31.2	5560	5880	5880	5760
	S5570-1A-253	253cm	35.1	6255	6615	6615	6480
	S5570-1A-281	281cm	39	6950	7350	7350	7200
	S5570-1A-309	309cm	42.9	7645	8085	8085	7920
	S5570-1A-337	337cm	46.8	8340	8820	8820	8640
	S5570-1A-365	365cm	50.7	9035	9555	9555	9360
	S5570-1A-393	393cm	54.6	9730	10290	10290	10080
	S5570-1A-421	421cm	58.5	10425	11025	11025	10800
S5570-1A-449	449cm	62.4	11120	11760	11760	11520	

wattage: 13.5 W/m

S5570-1B-57	57cm	11.6	1960	2070	2070	2020
S5570-1B-85	85cm	17.4	2940	3105	3105	3030
S5570-1B-113	113cm	23.2	3920	4140	4140	4040
S5570-1B-141	141cm	29	4900	5175	5175	5050
S5570-1B-169	169cm	34.8	5880	6210	6210	6060
S5570-1B-197	197cm	40.6	6860	7245	7245	7070
S5570-1B-225	225cm	46.4	7840	8280	8280	8080
S5570-1B-253	253cm	52.2	8820	9315	9315	9090
S5570-1B-281	281cm	58	9800	10350	10350	10100
S5570-1B-309	309cm	63.8	10780	11385	11385	11110
S5570-1B-337	337cm	69.6	11760	12420	12420	12120
S5570-1B-365	365cm	75.4	12740	13455	13455	13130
S5570-1B-393	393cm	81.2	13720	14490	14490	14140
S5570-1B-421	421cm	87	14700	15525	15525	15150
S5570-1B-449	449cm	92.8	15680	16560	16560	16160

wattage: 20 W/m

Το φωτιστικό είναι διαθέσιμο σε μήκος πολλαπλάσιο των 14 εκατοστών  
 The illuminant is available in lengths that are multiples of 14 centimeters.



## LINEAR 55×70 SUSPENDED / Lumen output tables

	code	length	watt	lumens 3000K	lumens 4000K	lumens 5000K	lumens 6500K
CATEGORY 2A 350mA (2A)	S5570-2A-57	57cm	23.6	4080	4380	4380	4080
	S5570-2A-85	85cm	35.4	6120	6570	6570	6120
	S5570-2A-113	113cm	47.2	8160	8760	8760	8160
	S5570-2A-141	141cm	59	10200	10950	10950	10200
	S5570-2A-169	169cm	70.8	12240	13140	13140	12240
	S5570-2A-197	197cm	82.6	14280	15330	15330	14280
	S5570-2A-225	225cm	94.4	16320	17520	17520	16320
	S5570-2A-253	253cm	106.2	18360	19710	19710	18360
	S5570-2A-281	281cm	118	20400	21900	21900	20400
	S5570-2A-309	309cm	129.8	22440	24090	24090	22440
	S5570-2A-337	337cm	141.6	24480	26280	26280	24480
	S5570-2A-365	365cm	153.4	26520	28470	28470	26520
	S5570-2A-393	393cm	165.2	28560	30660	30660	28560
	S5570-2A-421	421cm	177	30600	32850	32850	30600
	S5570-2A-449	449cm	188.8	32640	35040	35040	32640

wattage: 40.5 W/m

CATEGORY 2B 500mA (2B)	S5570-2B-57	57cm	35	5700	6140	6140	5700
	S5570-2B-85	85cm	52.5	8550	9210	9210	8550
	S5570-2B-113	113cm	70	11400	12280	12280	11400
	S5570-2B-141	141cm	87.5	14250	15350	15350	14250
	S5570-2B-169	169cm	105	17100	18420	18420	17100
	S5570-2B-197	197cm	122.5	19950	21490	21490	19950
	S5570-2B-225	225cm	140	22800	24560	24560	22800
	S5570-2B-253	253cm	157.5	25650	27630	27630	25650
	S5570-2B-281	281cm	175	28500	30700	30700	28500
	S5570-2B-309	309cm	192.5	31350	33770	33770	31350
	S5570-2B-337	337cm	210	34200	36840	36840	34200
	S5570-2B-365	365cm	227.5	37050	39910	39910	37050
	S5570-2B-393	393cm	245	39900	42980	42980	39900
	S5570-2B-421	421cm	262.5	42750	46050	46050	42750
	S5570-2B-449	449cm	280	45600	49120	49120	45600

wattage: 60.5 W/m

Το φωτιστικό είναι διαθέσιμο σε μήκος πολλαπλάσιο των 14 εκατοστών

The illuminant is available in lengths that are multiples of 14 centimeters.

DARK LINEAR 55×70 SUSPENDED (SD5570-)

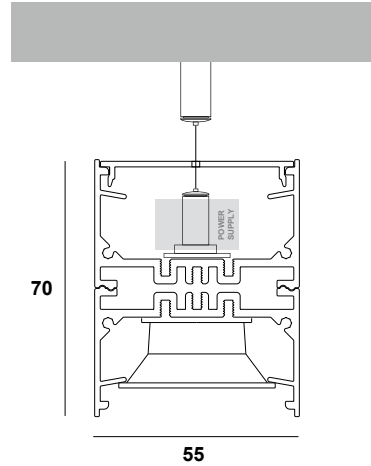

SD5570 - XX - XXX - X - XXX - XX - X - X

(a)	(b)	(c)	(d)	(e)	(f)	(g)	(h)
Κωδικός Γραμμικού Linear Code	Κατηγορία Category	Μήκος Length	Θερμοκρασία φωτός Color Temperature	Γωνία Δέσμης Beam Angle	Χρώμα προφίλ Profile Color	Χρώμα Ρεφλέκτορα Reflector Color	Αυξομείωση έντασης φωτός Dimming

Παράδειγμα κωδικού / Code example

DARK LINEAR 55×70 SUSPENDED 1A 84.5cm 3000K 65D Black with Black Reflector Dimmable  
SKU: SD5570-1A-85-3-60D-BL-1-D

material	pcb details	CRI	lumen output / W
Extruded aluminium / Plastic	SMD light & dark 7×1	Ra>90 (Ra>80 on request)	up to 205 Lm/W

CCT	beam angle	profile color	reflector color	dimming options (D)
3000K (3)	Medium 65D (60D)	Anodised (AN)	Black (1)	Push
4000K (4)	Wide 90D (90D)	Black (BL)	White (2)	DALI
5000K (5)		White (WH)		TRIAC 0/1-10V
6500K (6)		RAL (RL)		CASAMBI
TUNABLE 2700K - 6500K (TN)				Analog 0/1-10V

## DARK LINEAR 55×70 SUSPENDED / Lumen output tables

CATEGORY 1A 350mA (1A)	code	length	watt	lumens 3000K (65D)	lumens 3000K (90D)	lumens 4000K (65D)	lumens 4000K (90D)
	SD5570-1A-57	57cm	13.4	1702	1680	1774	1752
	SD5570-1A-85	85cm	20.1	2553	2520	2661	2628
	SD5570-1A-113	113cm	26.8	3404	3360	3548	3504
	SD5570-1A-141	141cm	33.5	4255	4200	4435	4380
	SD5570-1A-169	169cm	40.2	5106	5040	5322	5256
	SD5570-1A-197	197cm	46.9	5957	5880	6209	6132
	SD5570-1A-225	225cm	53.6	6808	6720	7096	7008
	SD5570-1A-253	253cm	60.3	7659	7560	7983	7884
	SD5570-1A-281	281cm	67	8510	8400	8870	8760
	SD5570-1A-309	309cm	73.7	9361	9240	9757	9636
	SD5570-1A-337	337m	80.4	10212	10080	10644	10512
	SD5570-1A-365	365m	87.1	11063	10920	11531	11388
	SD5570-1A-393	393cm	93.8	11914	11760	12418	12264
	SD5570-1A-421	421cm	100.5	12765	12600	13305	13140
	SD5570-1A-449	449cm	107.2	13616	13440	14192	14016

wattage: 23 W/m

CATEGORY 1B 500mA (1B)	code	length	watt	lumens 3000K (65D)	lumens 3000K (90D)	lumens 4000K (65D)	lumens 4000K (90D)
	SD5570-1B-57	57cm	19.8	2398	2368	2512	2480
	SD5570-1B-85	85cm	29.7	3597	3552	3768	3720
	SD5570-1B-113	113cm	39.6	4796	4736	5024	4960
	SD5570-1B-141	141cm	49.5	5995	5920	6280	6200
	SD5570-1B-169	169cm	59.4	7194	7104	7536	7440
	SD5570-1B-197	197cm	69.3	8393	8288	8792	8680
	SD5570-1B-225	225cm	79.2	9592	9472	10048	9920
	SD5570-1B-253	253cm	89.1	10791	10656	11304	11160
	SD5570-1B-281	281cm	99	11990	11840	12560	12400
	SD5570-1B-309	309cm	108.9	13189	13024	13816	13640
	SD5570-1B-337	337m	118.8	14388	14208	15072	14880
	SD5570-1B-365	365m	128.7	15587	15392	16328	16120
	SD5570-1B-393	393cm	138.6	16786	16576	17584	17360
	SD5570-1B-421	421cm	148.5	17985	17760	18840	18600
	SD5570-1B-449	449cm	158.4	19184	18944	20096	19840

wattage: 34 W/m

Το φωτιστικό είναι διαθέσιμο σε μήκος πολλαπλάσιο των 28 εκατοστών

The illuminant is available in lengths that are multiples of 28 centimeters.



SUSPENDED

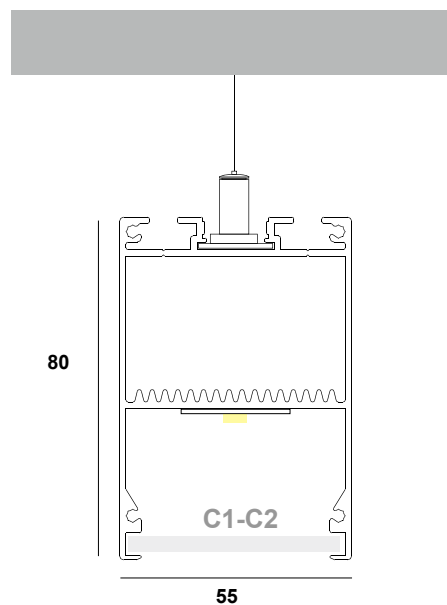



S5580 - XX - XXX - X - XX - XX - X

- |                                  |                       |                 |                                              |                                     |                  |                                        |
|----------------------------------|-----------------------|-----------------|----------------------------------------------|-------------------------------------|------------------|----------------------------------------|
| (a)                              | (b)                   | (c)             | (d)                                          | (e)                                 | (f)              | (g)                                    |
| Κωδικός Γραμμικού<br>Linear Code | Κατηγορία<br>Category | Μήκος<br>Length | Θερμοκρασία<br>φωτός<br>Color<br>Temperature | Χρώμα<br>προφίλ<br>Profile<br>color | Κάλυμμα<br>Cover | Αυξομείωση<br>έντασης φωτός<br>Dimming |

**Παράδειγμα κωδικού / Code example**

NILE 55×80 SUSPENDED 87cm 1A 3000K Black with Diffuser Dimmable  
**SKU:** S5580-1A-87-3-BL-C1-D

material	pcb details	CRI	lumen output / W
Extruded aluminium	Zhaga-Compliant Dimensions	Ra>80 ( <b>Ra&gt;90</b> on request)	up to 195 Lm/W

covers	profile color	CCT	dimming options (D)
Diffuser 3mm (-C1-) 	Anodised ( <b>AN</b> )	3000K ( <b>3</b> )	Push
	Black ( <b>BL</b> )	4000K ( <b>4</b> )	DALI
	White ( <b>WH</b> )	5000K ( <b>5</b> )	TRIAC 0/1-10V
Microprismatic 3mm (-C2-) 	RAL ( <b>RL</b> )	6500K ( <b>6</b> )	CASAMBI
		TUNABLE 2700K - 6500K ( <b>TN</b> )	Analog 0/1-10V

## NILE 55×80 SUSPENDED / Lumen output tables

	code	length	watt	lumens 3000K	lumens 4000K	lumens 5000K	lumens 6500K
CATEGORY 1A 350mA (1A)	S5580-1A-59	59cm	7.8	1390	1470	1470	1440
	S5580-1A-87	87cm	11.7	2085	2205	2205	2160
	S5580-1A-115	115cm	15.6	2780	2940	2940	2880
	S5580-1A-143	143cm	19.5	3475	3675	3675	3600
	S5580-1A-171	171cm	23.4	4170	4410	4410	4320
	S5580-1A-199	199cm	27.3	4865	5145	5145	5040
	S5580-1A-227	227cm	31.2	5560	5880	5880	5760
	S5580-1A-255	255cm	35.1	6255	6615	6615	6480
	S5580-1A-283	283cm	39	6950	7350	7350	7200
	S5580-1A-311	311cm	42.9	7645	8085	8085	7920
	S5580-1A-339	339cm	46.8	8340	8820	8820	8640
	S5580-1A-367	367cm	50.7	9035	9555	9555	9360
	S5580-1A-395	395cm	54.6	9730	10290	10290	10080
	S5580-1A-423	423cm	58.5	10425	11025	11025	10800
	S5580-1A-451	451cm	62.4	11120	11760	11760	11520

wattage: 13.5 W/m

CATEGORY 1B 500mA (1B)	S5580-1B-59	59cm	11.6	1960	2070	2070	2020
	S5580-1B-87	87cm	17.4	2940	3105	3105	3030
	S5580-1B-115	115cm	23.2	3920	4140	4140	4040
	S5580-1B-143	143cm	29	4900	5175	5175	5050
	S5580-1B-171	171cm	34.8	5880	6210	6210	6060
	S5580-1B-199	199cm	40.6	6860	7245	7245	7070
	S5580-1B-227	227cm	46.4	7840	8280	8280	8080
	S5580-1B-255	255cm	52.2	8820	9315	9315	9090
	S5580-1B-283	283cm	58	9800	10350	10350	10100
	S5580-1B-311	311cm	63.8	10780	11385	11385	11110
	S5580-1B-339	339cm	69.6	11760	12420	12420	12120
	S5580-1B-367	367cm	75.4	12740	13455	13455	13130
	S5580-1B-395	395cm	81.2	13720	14490	14490	14140
	S5580-1B-423	423cm	87	14700	15525	15525	15150
	S5580-1B-451	451cm	92.8	15680	16560	16560	16160

wattage: 20 W/m

Το φωτιστικό είναι διαθέσιμο σε μήκος πολλαπλάσιο των 14 εκατοστών

The illuminant is available in lengths that are multiples of 14 centimeters.



## NILE 55×80 SUSPENDED / Lumen output tables

	code	length	watt	lumens 3000K	lumens 4000K	lumens 5000K	lumens 6500K
CATEGORY 2A 350mA (2A)	S5580-2A-59	59cm	23.6	4080	4380	4380	4080
	S5580-2A-87	87cm	35.4	6120	6570	6570	6120
	S5580-2A-115	115cm	47.2	8160	8760	8760	8160
	S5580-2A-143	143cm	59	10200	10950	10950	10200
	S5580-2A-171	171cm	70.8	12240	13140	13140	12240
	S5580-2A-199	199cm	82.6	14280	15330	15330	14280
	S5580-2A-227	227cm	94.4	16320	17520	17520	16320
	S5580-2A-255	255cm	106.2	18360	19710	19710	18360
	S5580-2A-283	283cm	118	20400	21900	21900	20400
	S5580-2A-311	311cm	129.8	22440	24090	24090	22440
	S5580-2A-339	339cm	141.6	24480	26280	26280	24480
	S5580-2A-367	367cm	153.4	26520	28470	28470	26520
	S5580-2A-395	395cm	165.2	28560	30660	30660	28560
	S5580-2A-423	423cm	177	30600	32850	32850	30600
S5580-2A-451	451cm	188.8	32640	35040	35040	32640	

wattage: 40.5 W/m

CATEGORY 2B 500mA (2B)	S5580-2B-59	59cm	35	5700	6140	6140	5700
	S5580-2B-87	87cm	52.5	8550	9210	9210	8550
	S5580-2B-115	115cm	70	11400	12280	12280	11400
	S5580-2B-143	143cm	87.5	14250	15350	15350	14250
	S5580-2B-171	171cm	105	17100	18420	18420	17100
	S5580-2B-199	199cm	122.5	19950	21490	21490	19950
	S5580-2B-227	227cm	140	22800	24560	24560	22800
	S5580-2B-255	255cm	157.5	25650	27630	27630	25650
	S5580-2B-283	283cm	175	28500	30700	30700	28500
	S5580-2B-311	311cm	192.5	31350	33770	33770	31350
	S5580-2B-339	339cm	210	34200	36840	36840	34200
	S5580-2B-367	367cm	227.5	37050	39910	39910	37050
	S5580-2B-395	395cm	245	39900	42980	42980	39900
	S5580-2B-423	423cm	262.5	42750	46050	46050	42750
S5580-2B-451	451cm	280	45600	49120	49120	45600	

wattage: 60.5 W/m

Το φωτιστικό είναι διαθέσιμο σε μήκος πολλαπλάσιο των 14 εκατοστών

The illuminant is available in lengths that are multiples of 14 centimeters.



SUSPENDED



UPDOWN

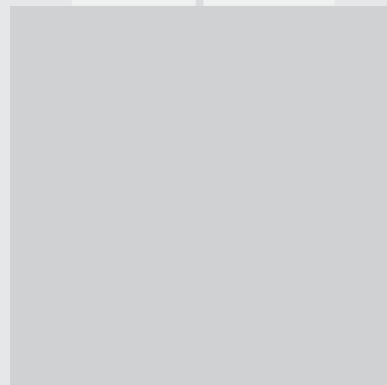

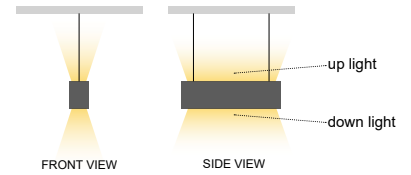
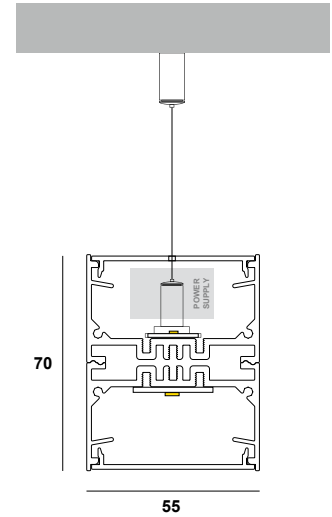

U5570 - XX - XX - XXX - XX - XX - XX - XX - X

- (a) Κωδικός Γραμμικού  
Linear Code
- (b) Κατηγορία downlight  
Category downlight
- (c) Ισχύς uplight  
Wattage uplight
- (d) Μήκος  
Length
- (e) CCT downlight
- (f) CCT uplight
- (g) Χρώμα προφίλ  
Profile color
- (h) Κάλυμμα  
Cover
- (i) Αυξομείωση έντασης φωτός  
Dimming

**Παράδειγμα κωδικού / Code example**

LINEAR 55×70 UPDOWN 1A + 6W/m Uplight 85cm 3000K Downlight 3000K Uplight Black with Diffuser Dimmable  
SKU: U5570-1A-6W-85-3-3-BL-C1-D

material	Pcb details	CRI	lumen output / W	Dimming options
Extruded aluminium	Zhaga-Compliant Dimensions	Ra>80 (Ra>90 on request)	up to 195 Lm/W	Push DALI TRIAC 0/1-10V CASAMBI Analog 0/1-10V

CCT down lighting	wattage up lighting	CCT up lighting	profile color	covers for down lighting
3000K (3)	6 W/m White (6W)	3000K (3) for up lighting 6W 9W 12W	Anodised (AN)	Acrylic Diffuser ( -C1-)
4000K (4)	9 W/m White (9W)	4000K (4) for up lighting 6W 9W 12W	Black (BL)	
5000K (5)	12 W/m White (12W)	5000K (5) for up lighting 6W 9W 12W	White (WH)	Acrylic Microprismatic ( -C2-)
6500K (6)	12 W/m RGBW (12C)	6500K (6) for up lighting 6W 9W 12W	RAL (RL)	
TUNABLE 2700K - 6500K (TN)	16 W/m RGB (16C)	RGBCW (C2) for up lighting 12C		
		RGBWW (C3) for up lighting 12C		
		RGB for up lighting 16C		
		TUNABLE 2700K - 6500K (TN)		

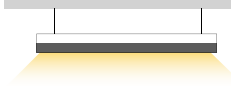

## DOWN LIGHT WATTAGE - LUMENS TABLE

CATEGORY 1A 350mA (1A)	code	length	watt	lumens 3000K	lumens 4000K	lumens 5000K	lumens 6500K
	U5570-1A-__-57	57cm	7.8	1390	1470	1470	1440
	U5570-1A-__-85	85cm	11.7	2085	2205	2205	2160
	U5570-1A-__-113	113cm	15.6	2780	2940	2940	2880
	U5570-1A-__-141	141cm	19.5	3475	3675	3675	3600
	U5570-1A-__-169	169cm	23.4	4170	4410	4410	4320
	U5570-1A-__-197	197cm	27.3	4865	5145	5145	5040
	U5570-1A-__-225	225cm	31.2	5560	5880	5880	5760
	U5570-1A-__-253	253cm	35.1	6255	6615	6615	6480
	U5570-1A-__-281	281cm	39	6950	7350	7350	7200
	U5570-1A-__-309	309cm	42.9	7645	8085	8085	7920
	U5570-1A-__-337	337cm	46.8	8340	8820	8820	8640
	U5570-1A-__-365	365cm	50.7	9035	9555	9555	9360
	U5570-1A-__-393	393cm	54.6	9730	10290	10290	10080
	U5570-1A-__-421	421cm	58.5	10425	11025	11025	10800
	U5570-1A-__-449	449cm	62.4	11120	11760	11760	11520

CATEGORY 1B 500mA (1B)	code	length	watt	lumens 3000K	lumens 4000K	lumens 5000K	lumens 6500K
	U5570-1B-__-57	57cm	11.6	1960	2070	2070	2020
	U5570-1B-__-85	85cm	17.4	2940	3105	3105	3030
	U5570-1B-__-113	113cm	23.2	3920	4140	4140	4040
	U5570-1B-__-141	141cm	29	4900	5175	5175	5050
	U5570-1B-__-169	169cm	34.8	5880	6210	6210	6060
	U5570-1B-__-197	197cm	40.6	6860	7245	7245	7070
	U5570-1B-__-225	225cm	46.4	7840	8280	8280	8080
	U5570-1B-__-253	253cm	52.2	8820	9315	9315	9090
	U5570-1B-__-281	281cm	58	9800	10350	10350	10100
	U5570-1B-__-309	309cm	63.8	10780	11385	11385	11110
	U5570-1B-__-337	337cm	69.6	11760	12420	12420	12120
	U5570-1B-__-365	365cm	75.4	12740	13455	13455	13130
	U5570-1B-__-393	393cm	81.2	13720	14490	14490	14140
	U5570-1B-__-421	421cm	87	14700	15525	15525	15150
	U5570-1B-__-449	449cm	92.8	15680	16560	16560	16160

CATEGORY 2A 350mA (2A)	code	length	watt	lumens 3000K	lumens 4000K	lumens 5000K	lumens 6500K
	U5570-2A-__-57	57cm	23.6	4080	4380	4380	4080
	U5570-2A-__-85	85cm	35.4	6120	6570	6570	6120
	U5570-2A-__-113	113cm	47.2	8160	8760	8760	8160
	U5570-2A-__-141	141cm	59	10200	10950	10950	10200
	U5570-2A-__-169	169cm	70.8	12240	13140	13140	12240
	U5570-2A-__-197	197cm	82.6	14280	15330	15330	14280
	U5570-2A-__-225	225cm	94.4	16320	17520	17520	16320
	U5570-2A-__-253	253cm	106.2	18360	19710	19710	18360
	U5570-2A-__-281	281cm	118	20400	21900	21900	20400
	U5570-2A-__-309	309cm	129.8	22440	24090	24090	22440
	U5570-2A-__-337	337cm	141.6	24480	26280	26280	24480
	U5570-2A-__-365	365cm	153.4	26520	28470	28470	26520
	U5570-2A-__-393	393cm	165.2	28560	30660	30660	28560
	U5570-2A-__-421	421cm	177	30600	32850	32850	30600
	U5570-2A-__-449	449cm	188.8	32640	35040	35040	32640

CATEGORY 2B 500mA (2B)	code	length	watt	lumens 3000K	lumens 4000K	lumens 5000K	lumens 6500K
	U5570-2B-__-57	57cm	35	5700	6140	6140	5700
	U5570-2B-__-85	85cm	52.5	8550	9210	9210	8550
	U5570-2B-__-113	113cm	70	11400	12280	12280	11400
	U5570-2B-__-141	141cm	87.5	14250	15350	15350	14250
	U5570-2B-__-169	169cm	105	17100	18420	18420	17100
	U5570-2B-__-197	197cm	122.5	19950	21490	21490	19950
	U5570-2B-__-225	225cm	140	22800	24560	24560	22800
	U5570-2B-__-253	253cm	157.5	25650	27630	27630	25650
	U5570-2B-__-281	281cm	175	28500	30700	30700	28500
	U5570-2B-__-309	309cm	192.5	31350	33770	33770	31350
	U5570-2B-__-337	337cm	210	34200	36840	36840	34200
	U5570-2B-__-365	365cm	227.5	37050	39910	39910	37050
	U5570-2B-__-393	393cm	245	39900	42980	42980	39900
	U5570-2B-__-421	421cm	262.5	42750	46050	46050	42750
	U5570-2B-__-449	449cm	280	45600	49120	49120	45600

Το φωτιστικό είναι διαθέσιμο σε μήκος πολλαπλάσιο των 14 εκατοστών  
 The illuminant is available in lengths that are multiples of 14 centimeters.



## White

	length	watt	CCT uplighting
LED STRIP 6W/m White (6W)	57cm	3.6	3000K (3) 4000K (4) 5000K (5) 6500K (6)
	85cm	5.3	
	113cm	7	
	141cm	8.6	
	169cm	10.3	
	197cm	12	
	225cm	13.7	
	253cm	15.4	
	281cm	17	
	309cm	18.7	
	337cm	20.4	
	365cm	22.1	
	393cm	23.8	
	421cm	25.4	
	449cm	28.6	

	length	wattage	CCT uplighting
LED STRIP 9W/m White (9W)	57cm	5.4	3000K (3) 4000K (4) 5000K (5) 6500K (6)
	85cm	7.9	
	113cm	10.4	
	141cm	13	
	169cm	15.5	
	197cm	18	
	225cm	20.5	
	253cm	23	
	281cm	25.6	
	309cm	28.1	
	337cm	30.6	
	365cm	33.1	
	393cm	35.6	
	421cm	38.2	
	449cm	42.8	

	length	wattage	CCT uplighting
LED STRIP 12W/m White (12W)	57cm	7.2	3000K (3) 4000K (4) 5000K (5) 6500K (6)
	85cm	10.6	
	113cm	13.9	
	141cm	17.3	
	169cm	20.6	
	197cm	24	
	225cm	27.4	
	253cm	30.7	
	281cm	34.1	
	309cm	37.4	
	337cm	40.8	
	365cm	44.2	
	393cm	47.5	
	421cm	50.9	
	449cm	57.1	

## Colors

	length	wattage	CCT uplighting
LED STRIP 12W/m RGBW (12C)	57cm	7.2	RGB + 6500K (C2) RGB + 3000K (C3)
	85cm	10.6	
	113cm	13.9	
	141cm	17.3	
	169cm	20.6	
	197cm	24	
	225cm	27.4	
	253cm	30.7	
	281cm	34.1	
	309cm	37.4	
	337cm	40.8	
	365cm	44.2	
	393cm	47.5	
	421cm	50.8	
	449cm	57.1	

	length	wattage	CCT uplighting
LED STRIP 16W/m RGB (16C)	57cm	9.6	RGB
	85cm	14.1	
	113cm	18.6	
	141cm	23	
	169cm	27.5	
	197cm	32	
	225cm	36.5	
	253cm	41	
	281cm	45.4	
	309cm	49.9	
	337cm	54.4	
	365cm	58.9	
	393cm	63.4	
	421cm	67.8	
	449cm	76.2	

Το φωτιστικό είναι διαθέσιμο σε μήκος πολλαπλάσιο των 14 εκατοστών

The illuminant is available in lengths that are multiples of 14 centimeters.



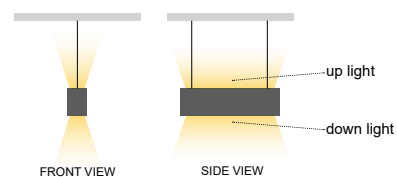
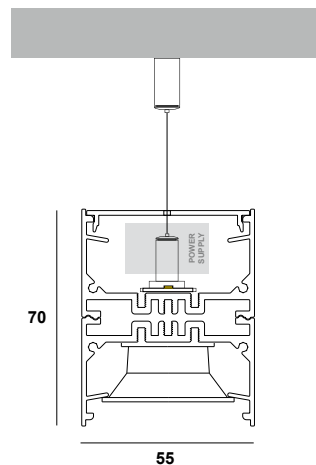

UD5570 - XX - XX - XXX - XX - XX - XX - XX - X - X

(a)	(b)	(c)	(d)	(e)	(f)	(g)	(h)	(i)	(j)
Κωδικός Γραμμικού Linear Code	Κατηγορία downlight Category downlight	Ισχύς uplight Wattage uplight	Μήκος Length	CCT downlight	CCT uplight	Γωνία δέσμης Beam angle	Χρώμα προφίλ Profile color	Χρώμα Ρεφλέκτορα Reflector color	Αυξομείωση έντασης φωτός Dimming

**Παράδειγμα κωδικού / Code example**

DARK LINEAR 55×70 UPDOWN 1A + 6W/m Uplight 84.5cm 3000K (Down) 3000K (Up) 65D Black with Black Reflector Dimmable  
 SKU: UD5570-1A-6W-85-3-3-60D-BL-1-D

material	profile color	reflector color	Pcb details	Dimming options
Extruded aluminium / Plastic	Anodised (AN)	Black (1)	SMD light & dark 7x1	Push
	Black (BL)	White (1)		DALI
	White (WH)			TRIAC 0/1-10V
	RAL (RL)			CASAMBI
				Analog 0/1-10V

CCT down lighting	beam angle down lighting	CRI	lumen output / W	wattage up lighting	CCT up lighting
3000K (3)	Medium 65D (60D)	Ra>90 (Ra>80 on request)	up to 205 Lm/W	6 W/m White (6W)	3000K (3) for up lighting 6W 9W 12W
4000K (4)	Wide 90D (90D)			9 W/m White (9W)	4000K (4) for up lighting 6W 9W 12W
5000K (5)				12 W/m White (12W)	5000K (5) for up lighting 6W 9W 12W
6500K (6)				12 W/m RGBW (12C)	6500K (6) for up lighting 6W 9W 12W
TUNABLE 2700K - 6500K (TN)				16 W/m RGB (16C)	RGBCW (C2) for up lighting 12C
					RGBWW (C3) for up lighting 12C
				RGB for up lighting 16C	
				TUNABLE 2700K - 6500K (TN)	

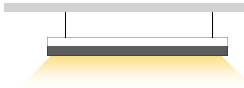

## DOWN LIGHT WATTAGE - LUMENS TABLE

CATEGORY 1A 350mA (1A)	code	length	watt	lumens 3000K (65D)	lumens 3000K (90D)	lumens 4000K (65D)	lumens 4000K (90D)
	UD5570-1A-_-56.5	56.5cm	13.4	1702	1680	1774	1752
	UD5570-1A-_-84.5	84.5cm	20.1	2553	2520	2661	2628
	UD5570-1A-_-112.5	112.5cm	26.8	3404	3360	3548	3504
	UD5570-1A-_-140.5	140.5cm	33.5	4255	4200	4435	4380
	UD5570-1A-_-168.5	168.5cm	40.2	5106	5040	5322	5256
	UD5570-1A-_-196.5	196.5cm	46.9	5957	5880	6209	6132
	UD5570-1A-_-224.5	224.5cm	53.6	6808	6720	7096	7008
	UD5570-1A-_-252.5	252.5cm	60.3	7659	7560	7983	7884
	UD5570-1A-_-280.5	280.5cm	67	8510	8400	8870	8760
	UD5570-1A-_-308.5	308.5cm	73.7	9361	9240	9757	9636
	UD5570-1A-_-336.5	336.5cm	80.4	10212	10080	10644	10512
	UD5570-1A-_-364.5	364.5cm	87.1	11063	10920	11531	11388
	UD5570-1A-_-392.5	392.5cm	93.8	11914	11760	12418	12264
	UD5570-1A-_-420.5	420.5cm	100.5	12765	12600	13305	13140
	UD5570-1A-_-448.5	448.5cm	107.2	13616	13440	14192	14016

CATEGORY 1B 500mA (1B)	code	length	watt	lumens 3000K (65D)	lumens 3000K (90D)	lumens 4000K (65D)	lumens 4000K (90D)
	UD5570-1B-_-56.5	56.5cm	19.8	2398	2368	2512	2480
	UD5570-1B-_-84.5	84.5cm	29.7	3597	3552	3768	3720
	UD5570-1B-_-112.5	112.5cm	39.6	4796	4736	5024	4960
	UD5570-1B-_-140.5	140.5cm	49.5	5995	5920	6280	6200
	UD5570-1B-_-168.5	168.5cm	59.4	7194	7104	7536	7440
	UD5570-1B-_-196.5	196.5cm	69.3	8393	8288	8792	8680
	UD5570-1B-_-224.5	224.5cm	79.2	9592	9472	10048	9920
	UD5570-1B-_-252.5	252.5cm	89.1	10791	10656	11304	11160
	UD5570-1B-_-280.5	280.5cm	99	11990	11840	12560	12400
	UD5570-1B-_-308.5	308.5cm	108.9	13189	13024	13816	13640
	UD5570-1B-_-336.5	336.5cm	118.8	14388	14208	15072	14880
	UD5570-1B-_-364.5	364.5cm	128.7	15587	15392	16328	16120
	UD5570-1B-_-392.5	392.5cm	138.6	16786	16576	17584	17360
	UD5570-1B-_-420.5	420.5cm	148.5	17985	17760	18840	18600
	UD5570-1B-_-448.5	448.5cm	158.4	19184	18944	20096	19840

Το φωτιστικό είναι διαθέσιμο σε μήκος πολλαπλάσιο των 28 εκατοστών

The illuminant is available in lengths that are multiples of 28 centimeters.



UP LIGHT OPTIONS

White

LED STRIP 6W/m White (6W)	length	watt	CCT uplighting
	56.5cm	3.6	3000K (3) 4000K (4) 5000K (5) 6500K (6)
	84.5cm	5.3	
	112.5cm	7	
	140.5cm	8.6	
	168.5cm	10.3	
	196.5cm	12	
	224.5cm	13.7	
	252.5cm	15.4	
	280.5cm	17	
	308.5cm	18.7	
	336.5cm	20.4	
	364.5cm	22.1	
	392.5cm	23.8	
	420.5cm	25.4	
448.5cm	28.6		

LED STRIP 9W/m White (9W)	length	wattage	CCT uplighting
	56.5cm	5.4	3000K (3) 4000K (4) 5000K (5) 6500K (6)
	84.5cm	7.9	
	112.5cm	10.4	
	140.5cm	13	
	168.5cm	15.5	
	196.5cm	18	
	224.5cm	20.5	
	252.5cm	23	
	280.5cm	25.6	
	308.5cm	28.1	
	336.5cm	30.6	
	364.5cm	33.1	
	392.5cm	35.6	
	420.5cm	38.2	
448.5cm	42.8		

LED STRIP 12W/m White (12W)	length	wattage	CCT uplighting
	56.5cm	7.2	3000K (3) 4000K (4) 5000K (5) 6500K (6)
	84.5cm	10.6	
	112.5cm	13.9	
	140.5cm	17.3	
	168.5cm	20.6	
	196.5cm	24	
	224.5cm	27.4	
	252.5cm	30.7	
	280.5cm	34.1	
	308.5cm	37.4	
	336.5cm	40.8	
	364.5cm	44.2	
	392.5cm	47.5	
	420.5cm	50.9	
448.5cm	57.1		

Colors

LED STRIP 12W/m RGBW (12C)	length	wattage	CCT uplighting
	56.5cm	7.2	RGB + 6500K (C2) RGB + 3000K (C3)
	84.5cm	10.6	
	112.5cm	13.9	
	140.5cm	17.3	
	168.5cm	20.6	
	196.5cm	24	
	224.5cm	27.4	
	252.5cm	30.7	
	280.5cm	34.1	
	308.5cm	37.4	
	336.5cm	40.8	
	364.5cm	44.2	
	392.5cm	47.5	
	420.5cm	50.8	
448.5cm	57.1		

LED STRIP 16W/m RGB (16C)	length	wattage	CCT uplighting
	56.5cm	9.6	RGB
	84.5cm	14.1	
	112.5cm	18.6	
	140.5cm	23	
	168.5cm	27.5	
	196.5cm	32	
	224.5cm	36.5	
	252.5cm	41	
	280.5cm	45.4	
	308.5cm	49.9	
	336.5cm	54.4	
	364.5cm	58.9	
	392.5cm	63.4	
	420.5cm	67.8	
448.5cm	76.2		

Το φωτιστικό είναι διαθέσιμο σε μήκος πολλαπλάσιο των 28 εκατοστών

The illuminant is available in lengths that are multiples of 28 centimeters.





SUSPENDED





# CURVE

LIGHTING SYSTEMS



# CIRCLES

Τα Circle® είναι ιδανικά για το φωτισμό μεγάλων επιφανειών. Μπορούν να χρησιμοποιηθούν σε δημόσια πολιτιστικά κτίρια, μουσεία και γκαλερί. Είναι ένα φωτιστικό που χρησιμοποιείται κυρίως από τους σχεδιαστές φωτισμού για να αναδείξουν επιφάνειες κτιρίων ή αρχιτεκτονικές κατασκευές. Αναζητώντας συνεχώς απλούστερους και πρακτικούς τρόπους για τη δημιουργία προφίλ φωτιστικών που να εφαρμόζουν όσο πιο εύκολα γίνεται, η **BARISLIGHT®** κατέληξε σε μια καινοτόμα ιδέα κυκλικών φωτιστικών που μπορεί να προσφέρει εξαιρετική φωτεινότητα και στυλ στο χώρο.

---

Circle® are ideal for lighting large surfaces. They can be used in public cultural buildings, museums and galleries. It is a luminaire mainly used by lighting designers to highlight building surfaces or architectural structures. Constantly looking for simpler and more practical ways to create lighting profiles that fit as easily as possible, **BARISLIGHT®** has come up with an innovative concept of circular lighting that can provide exceptional brightness and style to the space.

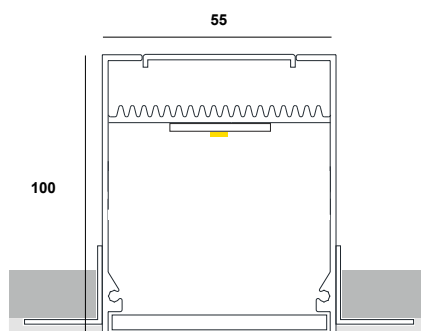

# TC55100 - XX - XXX - X - X

- (a)  
Κωδικός Γραμμικού  
Linear Code
- (b)  
Κατηγορία  
Category
- (c)  
Διάμετρος  
Diameter
- (d)  
Θερμοκρασία  
φωτός  
Color  
Temperature
- (f)  
Αυξομείωση  
έντασης φωτός  
Dimming

**Παράδειγμα κωδικού / Code example**

LINEAR 30×15 TRIMLESS 1A 90cm 3000K Dimmable  
**SKU:** T3015-1A-90-3-D

material	pcb details	CRI	lumen output / W
Extruded aluminium	Zhaga-Compliant Dimensions	Ra>80 ( <b>Ra&gt;90</b> on request)	up to 195 Lm/W

covers	CCT	dimming options (D)
 <b>Diffuser 5mm</b>	3000K (3)	Push
	4000K (4)	DALI
	5000K (5)	TRIAC 0/1-10V
	6500K (6)	CASAMBI
	TUNABLE 2700K - 6500K (TN)	Analog 0/1-10V

CIRCLES



**CIRCLE 55×100 TRIMLESS / Lumen output tables**

	code	diameter	watt	lumens 3000K	lumens 4000K	lumens 5000K	lumens 6500K
CATEGORY 1A 350mA (1A)	TC55100-1A-50	50cm	18	3150	3330	3330	3240
	TC55100-1A-60	60cm	22	3850	4070	4070	3960
	TC55100-1A-70	70cm	28	4900	5180	5180	5040
	TC55100-1A-80	80cm	32	5600	5920	5920	5760
	TC55100-1A-90	90cm	36	6300	6660	6660	6480
	TC55100-1A-100	100cm	40	7000	7400	7400	7200
	TC55100-1A-110	110cm	44	7700	8140	8140	7920
	TC55100-1A-120	120cm	48	8400	8880	8880	8640
	TC55100-1A-130	130cm	52	9100	9620	9620	9360
	TC55100-1A-140	140cm	56	9800	10360	10360	10080
	TC55100-1A-150	150cm	64	11200	11840	11840	11520
	TC55100-1A-160	160cm	68	11900	12580	12580	12240
	TC55100-1A-170	170cm	72	12600	13320	13320	12960
	TC55100-1A-180	180cm	76	13300	14060	14060	13680

CATEGORY 1B 500mA (1B)	TC55100-1B-50	50cm	26.1	4410	4680	4680	4545
	TC55100-1B-60	60cm	31.9	5390	5720	5720	5555
	TC55100-1B-70	70cm	40.6	6860	7280	7280	7070
	TC55100-1B-80	80cm	46.4	7840	8320	8320	8080
	TC55100-1B-90	90cm	52.2	8820	9360	9360	9090
	TC55100-1B-100	100cm	58	9800	10400	10400	10100
	TC55100-1B-110	110cm	63.8	10780	11440	11440	11110
	TC55100-1B-120	120cm	69.6	11760	12480	12480	12120
	TC55100-1B-130	130cm	75.4	12740	13520	13520	13130
	TC55100-1B-140	140cm	81.2	13720	14560	14560	14140
	TC55100-1B-150	150cm	92.8	15680	16640	16640	16160
	TC55100-1B-160	160cm	98.6	16660	17680	17680	17170
	TC55100-1B-170	170cm	104.4	17640	18720	18720	18180
	TC55100-1B-180	180cm	110.2	18620	19760	19760	19190

**CIRCLE 55×100 TRIMLESS / Lumen output tables**

	code	diameter	watt	lumens 3000K	lumens 4000K	lumens 5000K	lumens 6500K
CATEGORY 2A 350mA (2A)	TC55100-2A-50	50cm	36	6300	6660	6660	6480
	TC55100-2A-60	60cm	44	7700	8140	8140	7920
	TC55100-2A-70	70cm	56	9800	10360	10360	10080
	TC55100-2A-80	80cm	64	11200	11840	11840	11520
	TC55100-2A-90	90cm	72	12600	13320	13320	12960
	TC55100-2A-100	100cm	80	14000	14800	14800	14400
	TC55100-2A-110	110cm	88	15400	16280	16280	15840
	TC55100-2A-120	120cm	96	16800	17760	17760	17280
	TC55100-2A-130	130cm	104	18200	19240	19240	18720
	TC55100-2A-140	140cm	112	19600	20720	20720	20160
	TC55100-2A-150	150cm	128	22400	23680	23680	23040
	TC55100-2A-160	160cm	136	23800	25160	25160	24480
	TC55100-2A-170	170cm	144	25200	26640	26640	25920
	TC55100-2A-180	180cm	152	26600	28120	28120	27360

CATEGORY 2B 500mA (2B)	TC55100-2B-50	50cm	52.2	8820	9360	9360	9090
	TC55100-2B-60	60cm	63.8	10780	11440	11440	11110
	TC55100-2B-70	70cm	81.2	13720	14560	14560	14140
	TC55100-2B-80	80cm	92.8	15680	16640	16640	16160
	TC55100-2B-90	90cm	104.4	17640	18720	18720	18180
	TC55100-2B-100	100cm	116	19600	20800	20800	20200
	TC55100-2B-110	110cm	127.6	21560	22880	22880	22220
	TC55100-2B-120	120cm	139.2	23520	24960	24960	24240
	TC55100-2B-130	130cm	150.8	25480	27040	27040	26260
	TC55100-2B-140	140cm	162.4	27440	29120	29120	28280
	TC55100-2B-150	150cm	185.6	31360	33280	33280	32320
	TC55100-2B-160	160cm	197.2	33320	35360	35360	34340
	TC55100-2B-170	170cm	208.8	35280	37440	37440	36360
	TC55100-2B-180	180cm	220.4	37240	39520	39520	38380



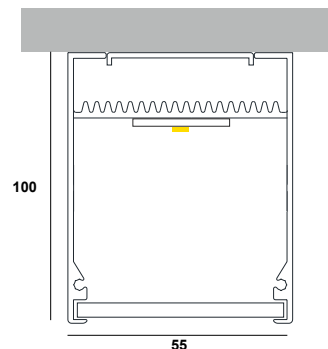

C55100 - XX - XXX - X - XX - X - XXX





- (a)  
Κωδικός Γραμμικού  
Linear Code
- (b)  
Κατηγορία  
Category
- (c)  
Διάμετρος  
Diameter
- (d)  
Θερμοκρασία  
φωτός  
Color  
Temperature
- (e)  
Χρώμα  
προφίλ  
Profile  
color
- (f)  
Αυξομείωση  
έντασης φωτός  
Dimming
- (g)  
Τοποθέτηση  
τροφοδοτικού  
Power supply  
placement

Παράδειγμα κωδικού / Code example

CIRCLE 55×100 1A Ø90cm 3000K Black Dimmable (Hidden Power supply)  
SKU: C55100-1A-90-3-BL-D-HP

material	pcb details	CRI	lumen output / W
Extruded aluminium	Zhaga-Compliant Dimensions	Ra>80 (Ra>90 on request)	up to 195 Lm/W

covers	CCT	profile color	dimming options (D)
 Diffuser 5mm	3000K (3)	Anodised (AN)	Push
	4000K (4)	Black (BL)	DALI
	5000K (5)	White (WH)	TRIAC 0/1-10V
	6500K (6)	RAL (RL)	CASAMBI
	TUNABLE 2700K - 6500K (TN)		Analog 0/1-10V

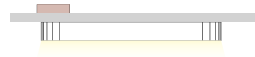
power supply installation	
<p>Μέσα σε ροζέτα Inside a rosette</p>  <ul style="list-style-type: none"> <li> Κυκλική ροζέτα Ø400×40mm Circular rosette Ø400×40mm <b>(-RP4-)</b></li> <li> Ορθογώνια ροζέτα 400×60×35mm Rectangular rosette 400×60×35mm <b>(-RP5-)</b></li> <li> Ορθογώνια ροζέτα 600×80×35mm Rectangular rosette 600×80×35mm <b>(-RP6-)</b></li> </ul>	<p>Κρυφό με πρόσβαση στο τροφοδοτικό Hidden with access to the power supply</p>  <b>(-HP-)</b>



CIRCLES

**CIRCLE 55×100 / Lumen output tables**

CATEGORY 1A 350mA (1A)	code	diameter	watt	lumens 3000K	lumens 4000K	lumens 5000K	lumens 6500K
	C55100-1A-50	50cm	18	3150	3330	3330	3240
	C55100-1A-60	60cm	22	3850	4070	4070	3960
	C55100-1A-70	70cm	28	4900	5180	5180	5040
	C55100-1A-80	80cm	32	5600	5920	5920	5760
	C55100-1A-90	90cm	36	6300	6660	6660	6480
	C55100-1A-100	100cm	40	7000	7400	7400	7200
	C55100-1A-110	110cm	44	7700	8140	8140	7920
	C55100-1A-120	120cm	48	8400	8880	8880	8640
	C55100-1A-130	130cm	52	9100	9620	9620	9360
	C55100-1A-140	140cm	56	9800	10360	10360	10080
	C55100-1A-150	150cm	64	11200	11840	11840	11520
	C55100-1A-160	160cm	68	11900	12580	12580	12240
	C55100-1A-170	170cm	72	12600	13320	13320	12960
C55100-1A-180	180cm	76	13300	14060	14060	13680	

CATEGORY 1B 500mA (1B)	C55100-1B-50	50cm	26.1	4410	4680	4680	4545
	C55100-1B-60	60cm	31.9	5390	5720	5720	5555
	C55100-1B-70	70cm	40.6	6860	7280	7280	7070
	C55100-1B-80	80cm	46.4	7840	8320	8320	8080
	C55100-1B-90	90cm	52.2	8820	9360	9360	9090
	C55100-1B-100	100cm	58	9800	10400	10400	10100
	C55100-1B-110	110cm	63.8	10780	11440	11440	11110
	C55100-1B-120	120cm	69.6	11760	12480	12480	12120
	C55100-1B-130	130cm	75.4	12740	13520	13520	13130
	C55100-1B-140	140cm	81.2	13720	14560	14560	14140
	C55100-1B-150	150cm	92.8	15680	16640	16640	16160
	C55100-1B-160	160cm	98.6	16660	17680	17680	17170
	C55100-1B-170	170cm	104.4	17640	18720	18720	18180
	C55100-1B-180	180cm	110.2	18620	19760	19760	19190

**CIRCLE 55×100 / Lumen output tables**

CATEGORY 2A 350mA (2A)	code	diameter	watt	lumens 3000K	lumens 4000K	lumens 5000K	lumens 6500K
	C55100-2A-50	50cm	36	6300	6660	6660	6480
	C55100-2A-60	60cm	44	7700	8140	8140	7920
	C55100-2A-70	70cm	56	9800	10360	10360	10080
	C55100-2A-80	80cm	64	11200	11840	11840	11520
	C55100-2A-90	90cm	72	12600	13320	13320	12960
	C55100-2A-100	100cm	80	14000	14800	14800	14400
	C55100-2A-110	110cm	88	15400	16280	16280	15840
	C55100-2A-120	120cm	96	16800	17760	17760	17280
	C55100-2A-130	130cm	104	18200	19240	19240	18720
	C55100-2A-140	140cm	112	19600	20720	20720	20160
	C55100-2A-150	150cm	128	22400	23680	23680	23040
	C55100-2A-160	160cm	136	23800	25160	25160	24480
	C55100-2A-170	170cm	144	25200	26640	26640	25920
C55100-2A-180	180cm	152	26600	28120	28120	27360	

C55100-2B-50	50cm	52.2	8820	9360	9360	9090
C55100-2B-60	60cm	63.8	10780	11440	11440	11110
C55100-2B-70	70cm	81.2	13720	14560	14560	14140
C55100-2B-80	80cm	92.8	15680	16640	16640	16160
C55100-2B-90	90cm	104.4	17640	18720	18720	18180
C55100-2B-100	100cm	116	19600	20800	20800	20200
C55100-2B-110	110cm	127.6	21560	22880	22880	22220
C55100-2B-120	120cm	139.2	23520	24960	24960	24240
C55100-2B-130	130cm	150.8	25480	27040	27040	26260
C55100-2B-140	140cm	162.4	27440	29120	29120	28280
C55100-2B-150	150cm	185.6	31360	33280	33280	32320
C55100-2B-160	160cm	197.2	33320	35360	35360	34340
C55100-2B-170	170cm	208.8	35280	37440	37440	36360
C55100-2B-180	180cm	220.4	37240	39520	39520	38380

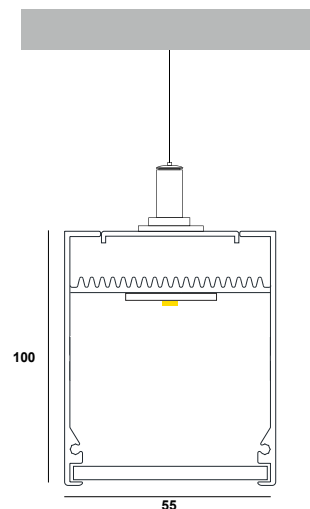
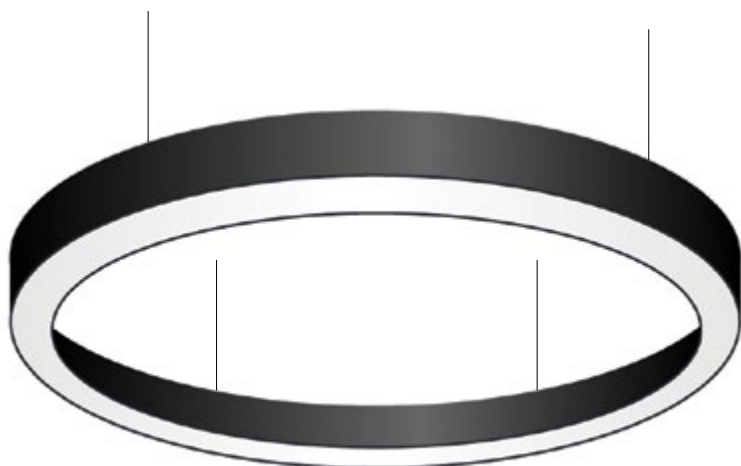

SC55100 - XX - XXX - X - XX - X - XXX



(a)	(b)	(c)	(d)	(e)	(f)	(g)
Κωδικός Γραμμικού Linear Code	Κατηγορία Category	Διάμετρος Diameter	Θερμοκρασία φωτός Color Temperature	Χρώμα προφίλ Profile color	Αυξομείωση έντασης φωτός Dimming	Τοποθέτηση τροφοδοτικού Power supply placement

Παράδειγμα κωδικού / Code example

CIRCLE 55×100 SUSPENDED 1A Ø90cm 3000K Black Dimmable (Hidden Power supply)  
SKU: SC55100-1A-90-3-BL-D-HP

material	pcb details	CRI	lumen output / W
Extruded aluminium	Zhaga-Compliant Dimensions	Ra>80 (Ra>90 on request)	up to 195 Lm/W

covers	CCT	profile color	dimming options (D)
 <p>Diffuser 5mm</p>	3000K (3)	Anodised (AN)	Push
	4000K (4)	Black (BL)	DALI
	5000K (5)	White (WH)	TRIAC 0/1-10V
	6500K (6)	RAL (RL)	CASAMBI
	TUNABLE 2700K - 6500K (TN)		Analog 0/1-10V

power supply installation	
<p>Μέσα σε ροζέτα Inside a rosette</p> 	<p>Κυκλική ροζέτα Ø400×40mm Circular rosette Ø400×40mm (-RP4-)</p> <p>Ορθογώνια ροζέτα 400×60×35mm Rectangular rosette 400×60×35mm (-RP5-)</p> <p>Ορθογώνια ροζέτα 600×80×35mm Rectangular rosette 600×80×35mm (-RP6-)</p>
	<p>Κρυφό με πρόσβαση στο τροφοδοτικό Hidden with access to the power supply</p>  <p>(-HP-)</p>





CIRCLES



**CIRCLE 55×100 SUSPENDED / Lumen output tables**

CATEGORY 1A 350mA (1A)	code	diameter	watt	lumens 3000K	lumens 4000K	lumens 5000K	lumens 6500K
	SC55100-1A-50	50cm	18	3150	3330	3330	3240
	SC55100-1A-60	60cm	22	3850	4070	4070	3960
	SC55100-1A-70	70cm	28	4900	5180	5180	5040
	SC55100-1A-80	80cm	32	5600	5920	5920	5760
	SC55100-1A-90	90cm	36	6300	6660	6660	6480
	SC55100-1A-100	100cm	40	7000	7400	7400	7200
	SC55100-1A-110	110cm	44	7700	8140	8140	7920
	SC55100-1A-120	120cm	48	8400	8880	8880	8640
	SC55100-1A-130	130cm	52	9100	9620	9620	9360
	SC55100-1A-140	140cm	56	9800	10360	10360	10080
	SC55100-1A-150	150cm	64	11200	11840	11840	11520
	SC55100-1A-160	160cm	68	11900	12580	12580	12240
	SC55100-1A-170	170cm	72	12600	13320	13320	12960
SC55100-1A-180	180cm	76	13300	14060	14060	13680	

CATEGORY 1B 500mA (1B)	SC55100-1B-50	50cm	26.1	4410	4680	4680	4545
	SC55100-1B-60	60cm	31.9	5390	5720	5720	5555
	SC55100-1B-70	70cm	40.6	6860	7280	7280	7070
	SC55100-1B-80	80cm	46.4	7840	8320	8320	8080
	SC55100-1B-90	90cm	52.2	8820	9360	9360	9090
	SC55100-1B-100	100cm	58	9800	10400	10400	10100
	SC55100-1B-110	110cm	63.8	10780	11440	11440	11110
	SC55100-1B-120	120cm	69.6	11760	12480	12480	12120
	SC55100-1B-130	130cm	75.4	12740	13520	13520	13130
	SC55100-1B-140	140cm	81.2	13720	14560	14560	14140
	SC55100-1B-150	150cm	92.8	15680	16640	16640	16160
	SC55100-1B-160	160cm	98.6	16660	17680	17680	17170
	SC55100-1B-170	170cm	104.4	17640	18720	18720	18180
	SC55100-1B-180	180cm	110.2	18620	19760	19760	19190

**CIRCLE 55×100 SUSPENDED / Lumen output tables**

CATEGORY 2A 350mA (2A)	code	diameter	watt	lumens 3000K	lumens 4000K	lumens 5000K	lumens 6500K
	SC55100-2A-50	50cm	36	6300	6660	6660	6480
	SC55100-2A-60	60cm	44	7700	8140	8140	7920
	SC55100-2A-70	70cm	56	9800	10360	10360	10080
	SC55100-2A-80	80cm	64	11200	11840	11840	11520
	SC55100-2A-90	90cm	72	12600	13320	13320	12960
	SC55100-2A-100	100cm	80	14000	14800	14800	14400
	SC55100-2A-110	110cm	88	15400	16280	16280	15840
	SC55100-2A-120	120cm	96	16800	17760	17760	17280
	SC55100-2A-130	130cm	104	18200	19240	19240	18720
	SC55100-2A-140	140cm	112	19600	20720	20720	20160
	SC55100-2A-150	150cm	128	22400	23680	23680	23040
	SC55100-2A-160	160cm	136	23800	25160	25160	24480
	SC55100-2A-170	170cm	144	25200	26640	26640	25920
SC55100-2A-180	180cm	152	26600	28120	28120	27360	

CATEGORY 2B 500mA (2B)	SC55100-2B-50	50cm	52.2	8820	9360	9360	9090
	SC55100-2B-60	60cm	63.8	10780	11440	11440	11110
	SC55100-2B-70	70cm	81.2	13720	14560	14560	14140
	SC55100-2B-80	80cm	92.8	15680	16640	16640	16160
	SC55100-2B-90	90cm	104.4	17640	18720	18720	18180
	SC55100-2B-100	100cm	116	19600	20800	20800	20200
	SC55100-2B-110	110cm	127.6	21560	22880	22880	22220
	SC55100-2B-120	120cm	139.2	23520	24960	24960	24240
	SC55100-2B-130	130cm	150.8	25480	27040	27040	26260
	SC55100-2B-140	140cm	162.4	27440	29120	29120	28280
	SC55100-2B-150	150cm	185.6	31360	33280	33280	32320
	SC55100-2B-160	160cm	197.2	33320	35360	35360	34340
	SC55100-2B-170	170cm	208.8	35280	37440	37440	36360
	SC55100-2B-180	180cm	220.4	37240	39520	39520	38380

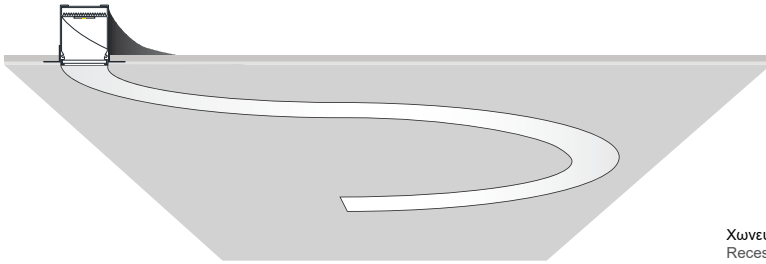

Χωνευτή τοποθέτηση  
Recessed Installation

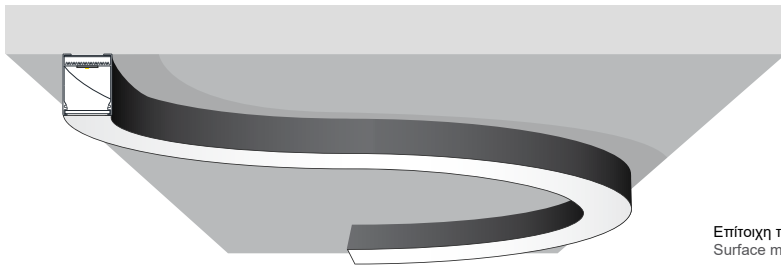
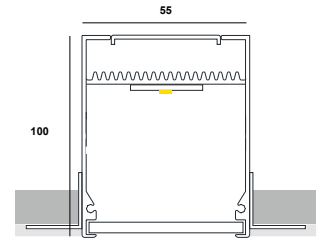

Επίτοιχη τοποθέτηση  
Surface mounted installation

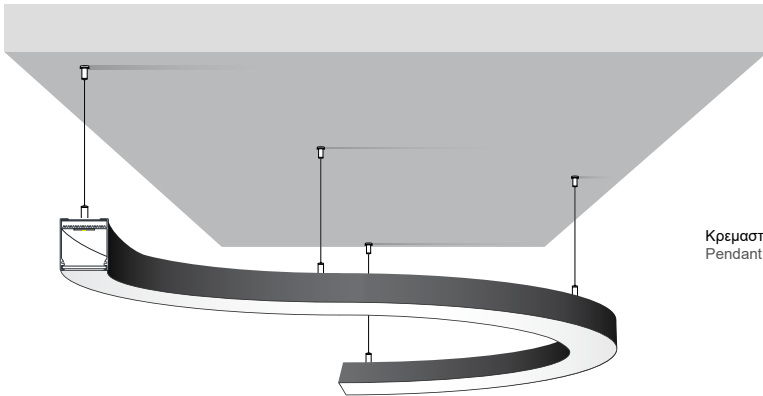
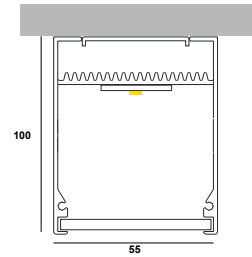

Κρεμαστή τοποθέτηση  
Pendant Installation

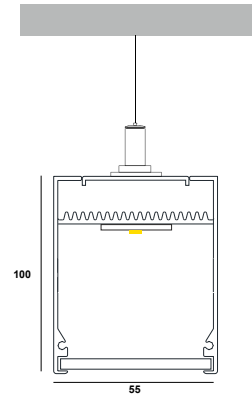

material	pcb details	CRI	lumen output / W
Extruded aluminium	Zhaga-Compliant Dimensions	Ra>80 ( <b>Ra&gt;90</b> on request)	up to 195 Lm/W

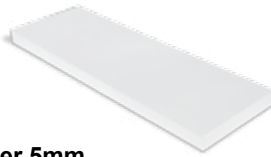
covers	CCT	profile color	dimming options (D)
 <p><b>Diffuser 5mm</b></p>	3000K (3)	Anodised ( <b>AN</b> )	Push
	4000K (4)	Black ( <b>BL</b> )	DALI
	5000K (5)	White ( <b>WH</b> )	TRIAC 0/1-10V
	6500K (6)	RAL ( <b>RL</b> )	CASAMBI
	TUNABLE 2700K - 6500K ( <b>TN</b> )		Analog 0/1-10V

IE



SPECIAL CONSTRUCTIONS

## How to build your custom-made Curves

Στην **BARISLIGHT®** μπορείτε να δημιουργήσετε μοναδικά και μοντέρνα καμπύλα φωτιστικά χώρου, χωνευτά, επίτοιχα ή κρεμαστά. Επιλέξτε ανάμεσα στις διαστάσεις που παρέχουμε, προσαρμόστε τα τεχνικά χαρακτηριστικά σύμφωνα με τις ανάγκες του χώρου σας, και δημιουργήστε μοναδικά σχέδια

At **BARISLIGHT®** you can create unique and modern curved lights, recessed, wall-mounted or suspended. Choose between the dimensions we provide, adapt the technical features according to the needs of your space, and create unique designs

### Ακτίνες κύκλου / Circle Radius

Το καμπύλο προφίλ μας μπορεί να καμφθεί σύμφωνα με τις παρακάτω ακτίνες.  
Our curved profile can be bent according to the following radius

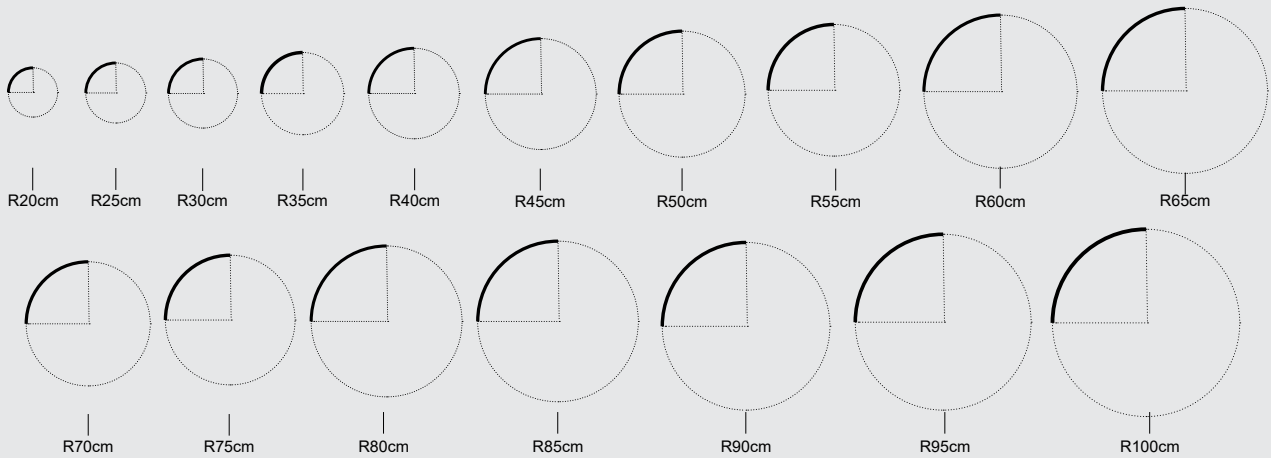

Σε συνεννόηση με την έμπειρη κατασκευαστική μας ομάδα, υπάρχουν αμέτρητες επιλογές για να δημιουργήσετε.  
In consultation with our experienced construction team, there are countless options for you to create.

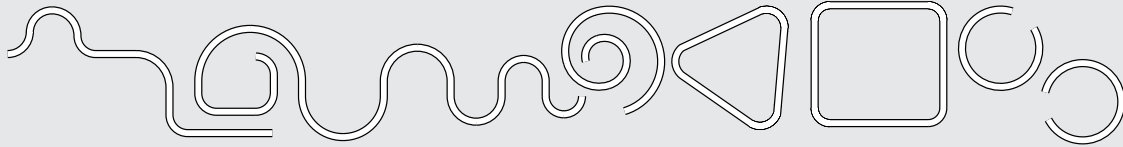

### Χρώμα / Color

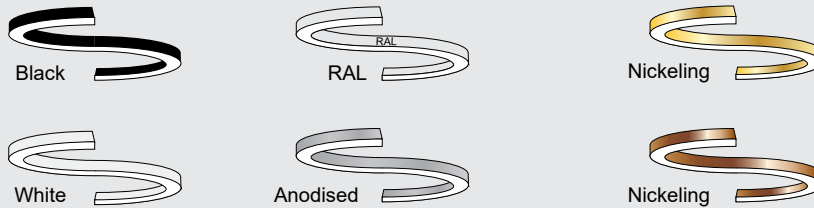

### Κατηγορία απόδοσης lumen / Lumen output class



### Θερμοκρασία φωτός / Kelvin







SPECIAL CONSTRUCTIONS



Επικοινωνώντας με την κατασκευαστική ομάδα της BarisLight, μπορείτε να δημιουργήσετε τον ιδανικό Γραμμικό φωτισμό για το χώρο σας, συνδυάζοντας τους αντιθαμβωτικούς φακούς Dark με κάλυμμα διάχυσης, δημιουργώντας εναλλαγές ανάλογα με τον φωτισμό που θέλετε να πετύχετε. Η ομάδα μας είναι έτοιμη να συζητήσει για τις ανάγκες του χώρου σας, και να σας προτείνει την ιδανική λύση.

By contacting the BarisLight manufacturing team, you can create the ideal Linear lighting for your space, combining the Dark anti-glare lenses with a diffusion cover, creating changes depending on the lighting you want to achieve. Our team is ready to discuss the needs of your space, and suggest the ideal solution.



DON 44x51mm  
Dark / Diffuse



LENA 55x35mm  
Dark / Diffuse



NILE RECESSED 55x80mm  
Dark / Diffuse

Τα γραμμικά μας DON 44x51, LENA 55x35 (χωρευτά / επίτοιχα / κρεμαστά), LINEAR 55x70 και NILE recessed 55x80 είναι σχεδιασμένα έτσι ώστε να υποδέχονται τόσο το κάλυμμα διάχυσης, όσο και τους αντιθαμβωτικούς φακούς Dark της BarisLight.

Our linear DON 44x51, LENA 55x35 (recessed / wall mounted / pendant), LINEAR 55x70 and NILE recessed 55x80 are designed to accept both the diffusion cover and the anti-glare Dark lenses of BarisLight





SPECIAL CONSTRUCTIONS

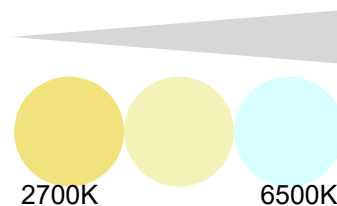

Η BarisLight® σας προσφέρει τη δυνατότητα να προσαρμόσετε το γραμμικό φωτισμό σας σύμφωνα με τις ανάγκες του χώρου σας όσο καλύτερα γίνεται. Με τα νέα μας γραμμικά Tunable 2700K - 6500K, μπορείτε να ελέγχετε απόλυτα το φωτισμό του χώρου σας και να τον προσαρμόζετε στις ανάγκες της εκάστοτε στιγμής. Επιλέγοντας 2700K, δημιουργείτε μια ζεστή ατμόσφαιρα ιδανική για χαλάρωση και φιλοξενία. Αντίθετα, επιλέγοντας 6500K, αναζωογονείτε το χώρο σας με ένα φως παρόμοιο με αυτό της ημέρας, ιδανικό για εργασία ή ανάγνωση.

BarisLight® offers you the possibility to customize your linear lighting according to the needs of your space as best as possible. With our new Linears Tunable 2700K - 6500K, you can have total control over the lighting of your space and adapt it to the needs of the moment. By choosing 2700K, you create a warm atmosphere ideal for relaxation and hospitality. On the other hand, by choosing 6500K, you brighten up your space with a light similar to daylight, ideal for working or reading.

Είτε πρόκειται για τα Dark γραμμικά μας, είτε για τα Diffuse, μπορείτε να επιλέξετε τις κατηγορίες **1A Tunable 2700K-6500K (T1)** ή **1B Tunable 2700K-6500K (T2)** και να ελέγξετε τον φωτισμό σας στο έπακρο.

Whether it's our Dark linear or Diffuse, you can choose **1A Tunable 2700K-6500K (T1)** or **1B Tunable 2700K-6500K (T2)** and control your lighting to the fullest.

length	wattage	lumens	
		2700K	6500K
60cm	11.8	1990	2070
90cm	17.6	2985	3105
120cm	23.5	3980	4140
150cm	29.4	4975	5175
180cm	35.3	5970	6210
210cm	41.2	6965	7245
240cm	47.0	7960	8280
270cm	52.9	8955	9315
300cm	58.8	9950	10350
330cm	64.7	10945	11385
360cm	70.6	11940	12420
390cm	76.4	12935	13455
420cm	82.3	13930	14490
450cm	88.2	14925	15525
480cm	94.1	15920	16560

1A TUNABLE 2700K-6500K 350mA (T1)

- Color dynamic from 2700K to 6500K
- Long service lifetime: >60000hrs
- Highly efficient: up to 175 Lm/W
- 300mm cutting length
- PUSH BUTTON / DALI

length	wattage	lumens	
		2700K	6500K
60cm	17.4	2790	2890
90cm	26.0	4185	4335
120cm	34.7	5580	5780
150cm	43.4	6975	7225
180cm	52.1	8370	8670
210cm	60.8	9765	10115
240cm	69.4	11160	11560
270cm	78.1	12555	13005
300cm	86.8	13950	14450
330cm	95.5	15345	15895
360cm	104.2	16740	17340
390cm	112.8	18135	18785
420cm	121.5	19530	20230
450cm	130.2	20925	21675
480cm	138.9	22320	23120

1B TUNABLE 2700K-6500K 500mA (T2)



6500K

4000K

2700K

TUNABLE 2700K - 6500K



Το Blu2Light είναι ένα ασύρματο σύστημα διαχείρισης φωτισμού που βασίζεται στην τεχνολογία Bluetooth®. Επιτρέπει τον βολικό, απλό και ασύρματο έλεγχο του φωτισμού μέσω εφαρμογών με χρήση κινητών συσκευών.

Με αυτόν τον τρόπο, μπορούν να συνδεθούν DALI, DMX, τροφοδοτικά LED, σένσορες και γενικά έλεγχος χώρου. Το σύστημα αυτό, μπορεί να χρησιμοποιηθεί για ένα ευρύ φάσμα εφαρμογών.

Blu2Light is a wireless lighting management system based on Bluetooth® technology. It allows convenient, simple and wireless control of lighting through applications using mobile devices.

In this way, DALI, DMX, LED power supplies, sockets and general room control can be connected. This system can be used for a wide range of applications

# Blu2Light

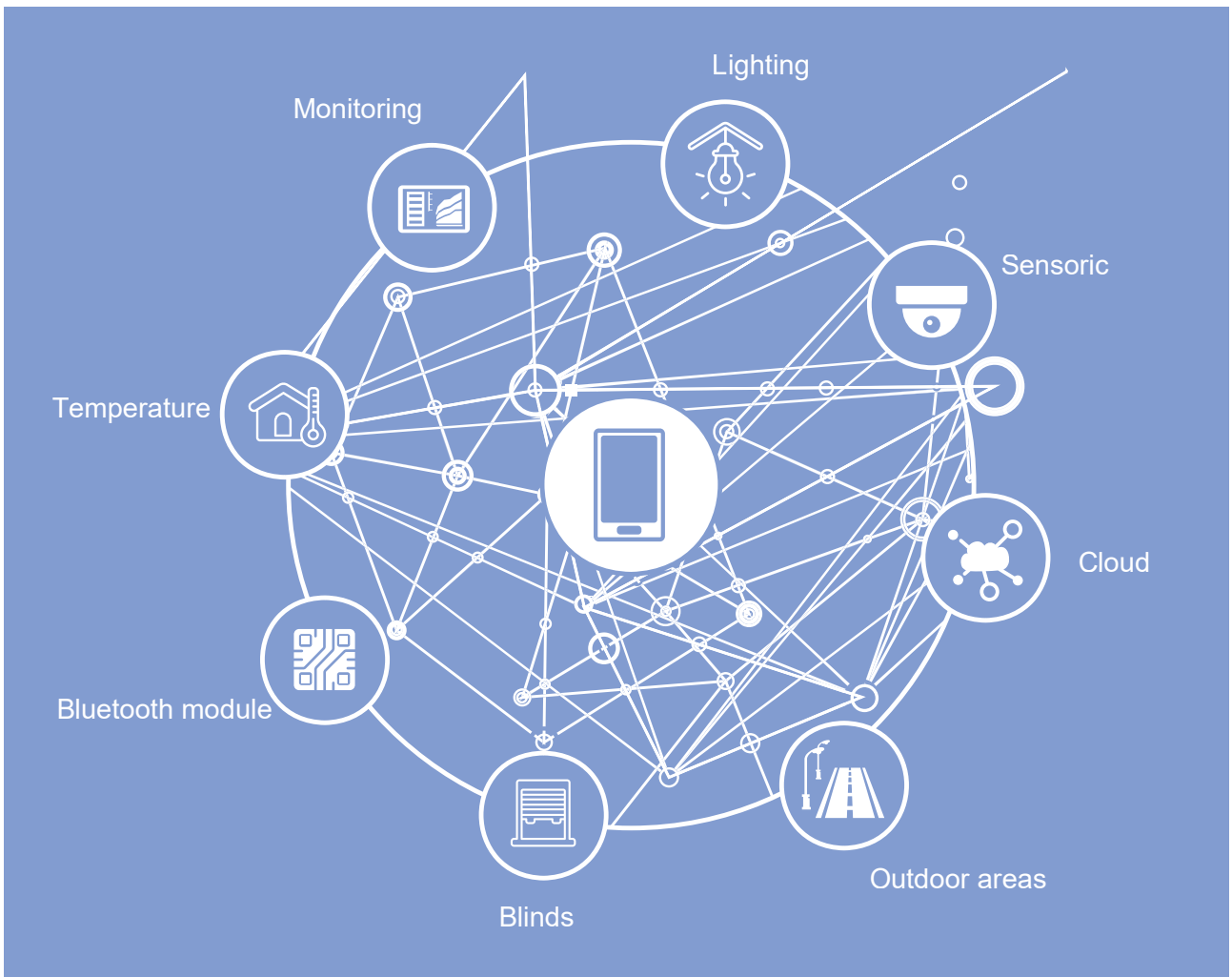
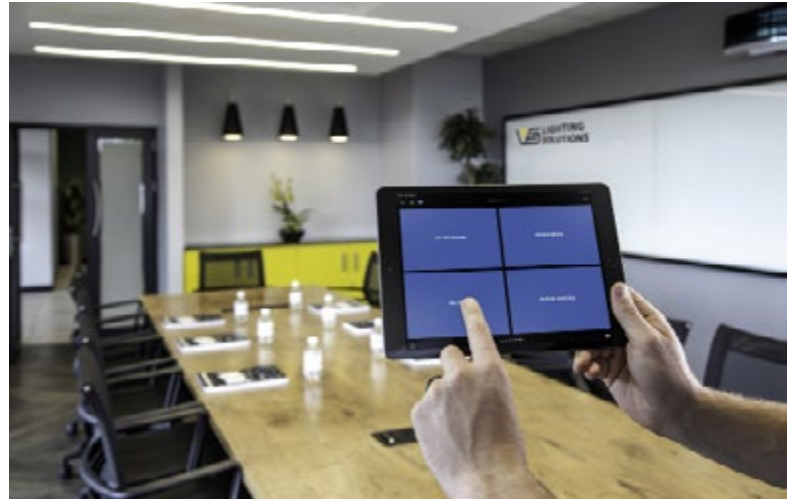



**BARISLIGHT**



## Όροι εγγύησης

Σε περίπτωση που μια συσκευή παρουσιάσει εντός του συμφωνημένου χρόνου ισχύος της εργοστασιακής εγγύησης της "BARIS LIGHT" σφάλμα υλικού ή κατασκευαστικό ελάττωμα, η συσκευή ή το ελαττωματικό εξάρτημα επισκευάζεται ή αντικαθίσταται από την "BARIS LIGHT" σύμφωνα με την κρίση της. Η "BARIS LIGHT" αναλαμβάνει την πλήρη ή μερική αντικατάσταση των απαραίτητων ανταλλακτικών για την επαναφορά της απρόσκοπτης λειτουργίας. Η "BARIS LIGHT" έχει δικαίωμα να χρησιμοποιεί μεταχειρισμένα, ανακατασκευασμένα ανταλλακτικά. Το εργατικό κόστος ή όποιο άλλο κόστος τρίτου δεν είναι υποχρέωση της "BARIS LIGHT". Η δυσαναλογία κατά την προαναφερόμενη έννοια συνίσταται ιδίως στην περίπτωση που οι απαιτούμενες ενέργειες θα συνεπάγονταν για την "BARIS LIGHT" έξοδα πέραν του ορίου του ανεκτού:

σε σχέση με την τιμή αγοράς ή/και την αξία της συσκευής σε κατάσταση χωρίς ελαττώματα, λαμβάνοντας υπόψη τη σοβαρότητα του ελαττώματος και κατ'εκτίμηση, εάν θα μπορούσαν να εφαρμοστούν εναλλακτικοί τρόποι αποκατάστασης του ελαττώματος χωρίς σημαντικές δυσχέρειες για τον αγοραστή. Επαφίεται ωστόσο στην κρίση της "BARIS LIGHT", να ζητήσει την αποστολή του ελαττωματικού εξαρτήματος για επισκευή ή αντικατάσταση. Η "BARIS LIGHT" έχει μόνο υποχρέωση για αφαίρεση ή τοποθέτηση του εξαρτήματος, εφόσον απαιτούνται ειδικές γνώσεις, τις οποίες δεν κατέχει ή δεν αναμένεται να κατέχει ο αγοραστής, διαφορετικά η υποχρέωση της "BARIS LIGHT" σε σχέση με το ελάττωμα εξαντλείται με την παράδοση του επισκευασμένου ή αντικατεστημένου εξαρτήματος στον αγοραστή.

Στην εργοστασιακή εγγύηση δεν περιλαμβάνονται επιπρόσθετα και τα έξοδα αποστολής, καθώς και ενδεχομένως τα έξοδα μετάβασης και παραμονής του προσωπικού συντήρησης της "BARIS LIGHT" για επιτόπιες επισκευές, κατά την εγκατάσταση συσκευών εντός της Ελλάδας καθώς επίσης και στις παρακάτω χώρες: Αυστρία, Βέλγιο, Βουλγαρία, Γαλλία, Γερμανία, Δημοκρατία της Τσεχίας, Ελβετία, Ελλάδα, Κύπρος, Ηνωμένα Αραβικά Εμιράτα, Ιαπωνία, Ινδία, Ισπανία, Ισραήλ, Ιταλία, Λουξεμβούργο, Μεγάλη Βρετανία, Νότιος Αφρική, Νότιος Κορέα, Ολλανδία, Πορτογαλία, Ταϊλάνδη, Χιλή. Αποκλείονται τελωνειακοί δασμοί, φόροι και λοιπά έξοδα εισαγωγής. Για τη Βόρεια Αμερική ισχύουν ξεχωριστοί όροι εγγύησης.

Αναλώσιμα και εξαρτήματα, που υπόκεινται σε φυσιολογική φθορά, δεν καλύπτονται από την παρούσα εγγύηση (π.χ. Μετασχηματιστές, τροφοδοτικά, πυκνωτές, ασφάλειες, φίλτρα, διατάξεις προστασίας από υπερφόρτιση).

Έκταση της εργοστασιακής εγγύησης  
Προϋπόθεση για την εκτέλεση παροχών εγγύησης χωρίς χρέωση είναι:

Ο αγοραστής οφείλει να γνωστοποιήσει άμεσα στην "BARIS LIGHT" τις διαπιστωμένες ελλείψεις, με μήνυμα με σύντομη περιγραφή του σφάλματος στη γραμμή εξυπηρέτησης "BARIS LIGHT".

Υποβολή ενός αντιγράφου του παραστατικού αγοράς

Η πινακίδα τύπου της συσκευής πρέπει να είναι απόλυτα ευανάγνωστη.

Συνεννόηση για τη διαδικασία με την "BARIS LIGHT" ή τους συνεργάτες σέρβις αυτής.

Για τη διενέργεια των σύμφωνα με την εκτίμηση της "BARIS LIGHT" απαραίτητων επισκευών και παραδόσεων αντικατάστασης, ο πελάτης οφείλει να παράσχει στην "BARIS LIGHT" τον απαιτούμενο χρόνο και την απαιτούμενη ευκαιρία. Τα παλιά, ελαττωματικά εξαρτήματα περιέρχονται στην ιδιοκτησία της "BARIS LIGHT". Η εργοστασιακή εγγύηση δεν καλύπτει ζημιές, που οφείλονται σε:

ζημιές κατά τη μεταφορά

λανθασμένη εγκατάσταση ή θέση σε λειτουργία από τον αγοραστή ή από τρίτους  
επεμβάσεις, τροποποιήσεις ή προσπάθειες επισκευής από τον αγοραστή ή από τρίτους  
παράβλεψη των οδηγιών χρήσης, των προδιαγραφών συντήρησης  
ακατάλληλη χρήση ή αδόκιμη λειτουργία

ανεπαρκή αερισμό της συσκευής (αν κρίνεται απαραίτητο από τις οδηγίες εγκατάστασης του προϊόντος)

ατυχήματα, εξωτερική επίδραση

ανωτέρα βία (π.χ. πτώση κεραυνού, υπέρταση, κακοκαιρία, πυρκαγιά)

Επίσης, δεν καλύπτει ελαττώματα αισθητικού χαρακτήρα ή σημάδια φθοράς, τα οποία δεν επηρεάζουν την τροφοδοσία ενέργειας. Εάν ο αγοραστής απαιτήσει με αυτή την εγγύηση μη απαραίτητες ή αναίτιες επεμβάσεις του σέρβις, η "BARIS LIGHT" έχει δικαίωμα να τον χρεώσει με τα έξοδα που θα προκύψουν. Το ίδιο ισχύει για χρόνους αναμονής, εάν ο αγοραστής δεν παράσχει στο προσωπικό συντήρησης άμεση πρόσβαση στην ελαττωματική συσκευή. Εφόσον δεν προβλέπεται ρητά από το νόμο ευθύνη της "BARIS LIGHT", η εργοστασιακή εγγύηση δεν περιλαμβάνει υποχρεώσεις πέραν των αναφερόμενων στους όρους της εγγύησης, ιδίως δε σε ότι αφορά την κάλυψη ζημιών που προέκυψαν άμεσα ή έμμεσα.

## Terms of Warranty

In the event that a device presents a material or manufacturing defect within the agreed warranty period of "BARIS LIGHT", the appliance or defective component is repaired or replaced by "BARIS LIGHT" at its discretion. "BARIS LIGHT" undertakes the replacement or replacement of the spare parts necessary to restore uninterrupted operation. "BARIS LIGHT" has the right to use used, remanufactured spare parts. The labor costs or any other cost of a third party is not an obligation of "BARIS LIGHT". The imbalance in the above-mentioned concept consists in particular in the event that the required actions would entail costs beyond the tolerable limit for "BARIS LIGHT":

in relation to the purchase price and / or the value of the appliance in a non-defective condition, taking into account the seriousness of the defect and, if so, whether alternative ways of remedying the defect could be applied without significant difficulties for the purchaser.

However, it is up to BARIS LIGHT to ask for the defective part to be repaired or replaced. "BARIS LIGHT" has only the obligation to remove or place the accessory if special knowledge is required which the purchaser does not own or are not expected to own, otherwise the obligation of "BARIS LIGHT" in relation to the defect is depleted by delivering the repaired or replaced component to the buyer.

The factory warranty does not include additionally shipping costs and, where applicable, the cost of travel and subsistence of BARIS LIGHT maintenance personnel for on-site repairs when installing appliances within Greece as well as in the following countries: Austria, Belgium, Bulgaria, France, Germany, Czech Republic, Switzerland, Greece, Cyprus, United Arab Emirates, Japan, India, Spain, Israel, Italy, Luxemburg, Great Britain, South Africa, South Korea, Netherlands, Portugal, Thailand, Chile or. Customs duties, taxes and other import charges are excluded. For North America, separate warranty terms apply.

Consumables and accessories subject to normal wear and tear are not covered by this warranty (eg Transformers, power supplies, capacitors, fuses, filters, overload protection devices).

## Scope of the factory warranty

The condition for the performance of free-of-charge warranty services is:

The buyer must immediately notify BARIS LIGHT of the deficiencies found, with a short description of the error in the service bar "BARIS LIGHT".

Submission of a copy of the purchase receipt

The type plate of the device must be perfectly legible.

Consultation on the procedure with "BARIS LIGHT" or its service partners.

In order to carry out the necessary repairs and replacement deliveries according to the "BARIS LIGHT" estimate, the customer must provide "BARIS LIGHT" with the required time and the required opportunity. The old, defective parts come to the property of "BARIS LIGHT". The factory warranty does not cover damages due to:

damage during transport

incorrect installation or commissioning by the buyer or by third parties

interventions, modifications, or repair efforts by the buyer or by third parties

ignoring instructions for use, maintenance specifications

inappropriate use or inadequate operation

insufficient ventilation of the appliance (if necessary as per the installation instructions for the product)

accidents, external impact

Force majeure (eg lightning strike, hypertension, bad weather, fire)

It also does not cover aesthetic defects or signs of wear, which do not affect the supply energy. If the buyer demands with this guarantee unnecessary or unnecessary service interventions, BARIS LIGHT is entitled to charge it with the costs incurred. The same applies for waiting times if the buyer does not provide maintenance personnel with direct access to the faulty device. As long as the liability of BARIS LIGHT is not expressly provided for by law, the factory warranty does not include obligations other than those specified in the terms of the guarantee, in particular as regards the coverage of losses incurred directly or indirectly.



Το προϊόν έχει ελεγχθεί και θεωρείται ότι πληροί τις ευρωπαϊκές προδιαγραφές ως προς την ασφάλεια και την προστασία της υγείας και του περιβάλλοντος.  
The product has been tested and is considered to meet European standards for safety, health and environmental protection.



Περιορισμός επικίνδυνων ουσιών: Το προϊόν συμμορφώνεται με την οδηγία RoHS και κάθε ομοιογενές υλικό δεν υπερβαίνει τα όρια για τα υλικά που αναφέρονται στην οδηγία RoHS (Pb, Hg, Cd, Cr6+, PBB και PBDE)  
Restriction of Hazardous Substances (RoHS): PRODUCT COMPLIES WITH rOhs directive and each homogenous material does not exceed the limits for materials mentioned under the RoHS directive (Pb,Hg,Cd, Cr6+, PBB and PBDE)



Το προϊόν διαθέτει εγγύηση χρόνων ίση με την αναγραφόμενη τιμή  
The product is guaranteed for a period of time equal to the number indicated.



Τύπος προστασίας: Μονός  
Safety class: One



Τύπος προστασίας: Διπλός  
Safety class: Two



Τύπος προστασίας: Τριπλός  
Safety class: Three



Η διάρκεια ζωής του προϊόντος ισούται με τον αριθμό ωρών που αναγράφονται.  
The lifetime of the product is equal to the number of hours indicated.



Προστασία από εισχώρηση σωμάτων Ø2.5mm  
Protection from ingress of Ø2.5mm elements



Προστασία από εισχώρηση σωμάτων Ø1mm  
Protection from ingress of Ø1mm elements



Προστασία από δυσλειτουργίες λόγω σκόνης και έκθεσης του υλικού στο νερό  
Protection from malfunctions due to dust and water



Πλήρης προστασία από σκόνη και έκθεσης του υλικού στο νερό  
Full protection from dust and exposure to water



Πλήρης προστασία από σκόνη και έκθεσης του υλικού στο νερό υψηλής πίεσης (Jet 12,5 l / min σε απόσταση 2,5 μέτρων από οποιαδήποτε κατεύθυνση)  
Full protection from dust and high pressure water (Jet of 12.5 l/min at a distance of 2.5 metres from any direction)



Πλήρης προστασία από σκόνη και έκθεσης του υλικού στο νερό υψηλής πίεσης (Jet 100l / min σε απόσταση 2,5 μέτρων από οποιαδήποτε κατεύθυνση)  
Full protection from dust and high pressure water (Powerful jets of 100 l/min at a distance of 2.5 metres from any direction)



Πλήρης προστασία από σκόνη και από ασυνεχή βύθιση στο νερό  
Full protection from dust and intermittent submersion in water



Πλήρης προστασία από σκόνη και από συνεχή βύθιση σε νερό σταθερής πίεσης  
Full protection from dust and against constant immersion in water under certain pressure



Το προϊόν προστατεύεται από πρόσκρουση 1 joule  
Product is protected against 1 joule of impact



Το προϊόν προστατεύεται από πρόσκρουση 2 joules  
Product is protected against 2 joules of impact



Το προϊόν προστατεύεται από πρόσκρουση 5 joules  
Product is protected against 5 joules of impact



Το προϊόν προστατεύεται από πρόσκρουση 10 joules  
Product is protected against 10 joules of impact



Το προϊόν προστατεύεται από πρόσκρουση 20 joules  
Product is protected against 20 joules of impact



Το προϊόν είναι ανθεκτικό στην υπεριώδη ακτινοβολία (UV) ή στο ηλιακό φως. Τα προϊόντα που δεν αντέχουν στην υπεριώδη ακτινοβολία μπορούν να υποβαθμιστούν ή να αποχρωματιστούν γρήγορα όταν εκτίθενται σε ακτινοβολία UV  
Product is resistant against ultraviolet (UV) light or sunlight. Non-UV resistant products can degrade or discolor fast when exposed UV light.



Το προϊόν έχει δοκιμαστεί για εφαρμογές walkover  
The product has been tested for walkover applications



Διαστάσεις τετράγωνης οπής (σε mm)  
Dimensions of square fitting opening (mm)



Διαστάσεις στρογγυλής οπής (σε mm)  
Dimensions of round fitting opening (mm)



Το προϊόν προορίζεται για εσωτερικό χώρο  
The product is intended for indoor use



Το προϊόν προορίζεται για εξωτερικό χώρο  
The product is intended for outdoor use



Το προϊόν προορίζεται για εσωτερικό και εξωτερικό χώρο  
The product is intended for both indoor and outdoor use



Το προϊόν προορίζεται για υποβρύχια τοποθέτηση  
The product is intended for underwater application



Επιφάνεια τοποθέτησης προϊόντος: Οροφή  
Product's installation surface: Ceiling



Επιφάνεια τοποθέτησης προϊόντος: Έδαφος  
Product's installation surface: Ground



Επιφάνεια τοποθέτησης προϊόντος: Τοίχος  
Product's installation surface: Wall



Σταθερή τάση 12/24 volt  
Constant Voltage 12/24 Volt



Σταθερή τάση 230VAC  
Constant Voltage 230VAC



Το προϊόν διαθέτει την δυνατότητα αυξομειώσεως της φωτεινότητας  
The product is dimmable.



Η γωνία δέσμης του προϊόντος ισούται με την αναγραφόμενη τιμή  
The beam angle of the product is equal to the indicated value



Το προϊόν εκπέμπει διάχυτο φως.  
The product emits diffuse light.



Η γωνία δέσμης του προϊόντος είναι 360°  
The beam angle of the product is 360°



Το προϊόν διαθέτει δυνατότητα περιστροφής ως προς τον οριζόντιο άξονα  
The product can be rotated on the horizontal axis



Το προϊόν διαθέτει δυνατότητα περιστροφής ως προς τον κάθετο άξονα  
The product can be rotated on the vertical axis



Το προϊόν διαθέτει δυνατότητα περιστροφής ως προς τον οριζόντιο και κάθετο άξονα  
The product can be rotated on both horizontal and vertical axis



Ο φακός του Downlight μπορεί να περιστραφεί σύμφωνα με τις αναγραφόμενες μοίρες  
The lens of the Downlight can be rotated according to the indicated degrees



Το προϊόν υποδέχεται λαμπτήρα τύπου GU10  
The product accepts GU10 type bulb



Η κάμψη της λωρίδας LED είναι δυνατή με ακτίνα  $\geq x$  χιλιοστόμετρα στην καθορισμένη κατεύθυνση  
Bending of the Led strip is possible with a radius of  $\geq x$  millimetres in the specified direction



Η ταινία LED διατίθεται σε καρούλι με μήκος όσο η αναγραφόμενη τιμή  
The LED strip is available on a reel with a length equal to the indicated price



Η ταινία LED κάμπτεται Πλάγια  
The LED strip is bent Sideways



Η ταινία LED κάμπτεται Κατακόρυφα  
The LED strip bends Vertically



Η ταινία LED κάμπτεται προς όλες τις κατευθύνσεις  
The LED strip bends in all directions



Η απόδοση Lumen / W του προϊόντος ισούται με την αναγραφόμενη τιμή  
The Lumen/W output of the product is equal to the indicated value



Η τιμή CRI του προϊόντος ισούται με την αναγραφόμενη τιμή  
The CRI rate of the product is equal to the indicated value



Θερμό Λευκό  
Warm White



Φυσικό Λευκό  
Natural White



Ψυχρό Λευκό  
Cold White



Ρυθμιζόμενη θερμοκρασία φωτός από Θερμό Λευκό σε Ψυχρό Λευκό  
Tunable light temperature from Warm White to Cool White



Κόκκινο  
Red



Πράσινο  
Green



Μπλε  
Blue



Πορτοκαλί  
Amber



RGB



RGBWW



RGBCW



[barislight.eu](http://barislight.eu)



[b2b.barislight.eu](http://b2b.barislight.eu)



**Έκθεση:**  
Ελ. Βενιζέλου και Βύρωνος,  
26333 Πάτρα

**Βιοτεχνία:**  
Γλαύκου 83, 26332 Πάτρα



2610 317 313  
2610 317 300



[info@barislight.eu](mailto:info@barislight.eu)



[barislight.eu](http://barislight.eu)  
[b2b.barislight.eu](http://b2b.barislight.eu)



Baris Light