

# DOT2 MODULE

## 2×4W 3000K CRI90 WHITE

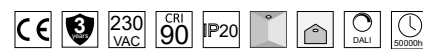

### ΠΕΡΙΕΧΟΜΕΝΑ / CONTENTS

DATASHEET ..... 1  
 MANUAL ..... 3

SKU: **MODLR2-XX-XX**

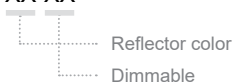

## DATASHEET

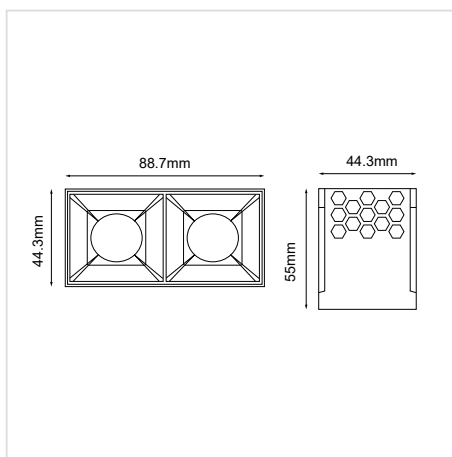

### GENERAL INFORMATION



APPLICATION	For TRIMLESS FRAME
DIRECTION OF MOUNTING	Ceiling
MATERIAL	Aluminium / PC
COLOR	White
VISIBLE DIMENSIONS (H×W×L)	55 × 44.3 × 88.7 mm
LIFE TIME	50000 hours
WARRANTY	3 years
ORIGIN	China

### ILLUMINANT

WATTAGE	2 × 4W
VOLTAGE	230V
LED	SMD
CCT	3000K
CRI	Ra>90
BEAM ANGLE	24D / 36D / 50D
LUMINOUS FLUX	82.5Lm/W
IP RATING	IP20
IK RATING	IK06

# DOT2 MODULE

## 2x4W 3000K CRI90 WHITE

Reflector color*		Dimmable*
White (WH)		Dim Triac (D1)
Black (BL)		Dim Dali Push (DDP)
Chrome (CR)		No Dim ( )

\* Υποχρεωτική επιλογή / Mandatory option

Δημιουργία Κωδικού προϊόντος / Product Code generator

**MODLR2- reflector color - dimmable**

EXAMPLE:

MODLR2-BL-DDP for DOT2 MODULE, black reflector, dim DALI PUSH

### TO BE USED WITH

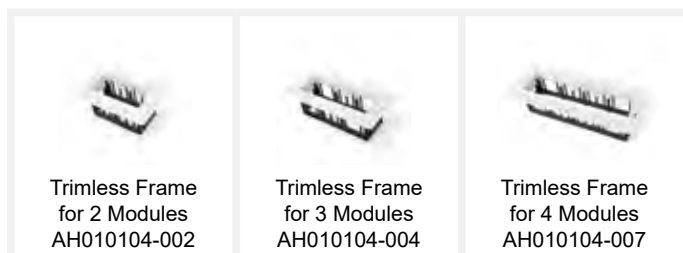



### ACCESSORIES



# DOT2 MODULE

## 2x4W 3000K CRI90 WHITE

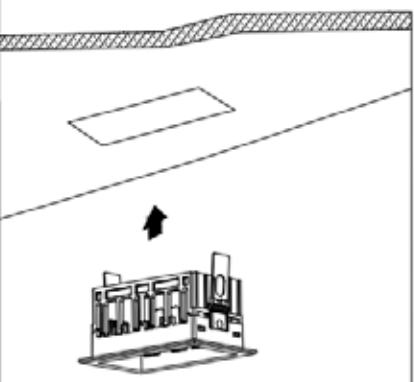
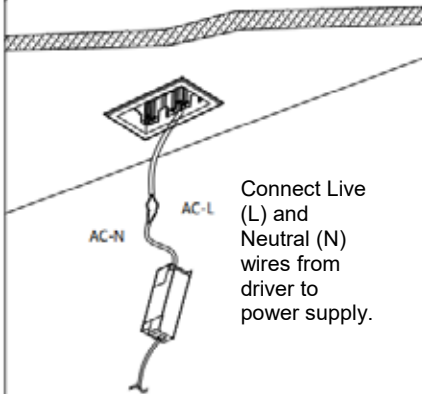
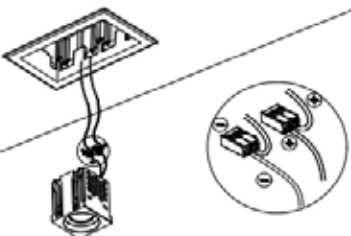
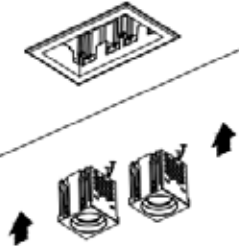
### MANUAL

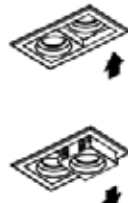
<p><b>1</b></p>  <p>Make sure the power is off before installation; Then make a suitable cut hole in the ceiling.</p>	<p><b>2</b> Pull up the springs and push the frame into the cut hole in ceiling.</p> 	<p><b>3</b></p>  <p>Connect Live (L) and Neutral (N) wires from driver to power supply.</p>
<p><b>4</b></p>  <p>Connect the Positive (+) and Negative(-) wires from the driver to the fixture accordingly.</p>	<p><b>5</b></p>  <p>Make sure the lock slot of the fixture aligns with the frame's slot and then slightly push it inside the frame.</p>	<p><b>6</b></p>  <p>First slot done. Installation complete; Power</p> <p><b>7</b></p>  <p>To remove the modules, push the module up for another 2 slots and the module will be released.</p>