

DOT4 MODULE

4x4W 3000K CRI90 WHITE

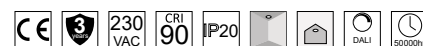

ΠΕΡΙΕΧΟΜΕΝΑ / CONTENTS

DATASHEET 1
 MANUAL 4

SKU: **MODLR4-XX-XX**

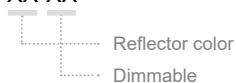

DATASHEET

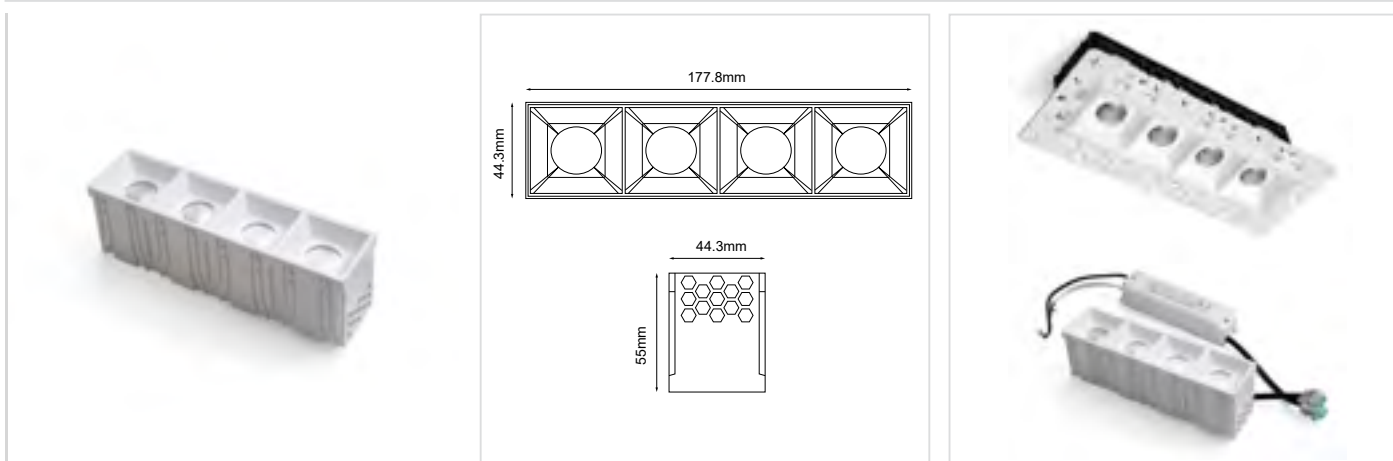

GENERAL INFORMATION



APPLICATION	For TRIMLESS FRAME
DIRECTION OF MOUNTING	Ceiling
MATERIAL	Aluminium / PC
COLOR	White
VISIBLE DIMENSIONS (H×W×L)	55 × 44.3 × 177.8 mm
LIFE TIME	50000 hours
WARRANTY	3 years
ORIGIN	China

ILLUMINANT

WATTAGE	4 × 4W
VOLTAGE	230V
LED	SMD
CCT	3000K
CRI	Ra>90
BEAM ANGLE	24D / 36D / 50D
LUMINOUS FLUX	83.2Lm/W
IP RATING	IP20
IK RATING	IK06

DOT4 MODULE

4x4W 3000K CRI90 WHITE

Reflector color*		Dimmable*
White (WH)		Dim Triac (D1)
Black (BL)		Dim Dali Push (DDP)
Chrome (CR)		No Dim ()

* Υποχρεωτική επιλογή / Mandatory option

Δημιουργία Κωδικού προϊόντος / Product Code generator

MODLR4- reflector color - dimmable

EXAMPLE:

MODLR4-BL-DDP for DOT4 MODULE, black reflector, dim DALI PUSH

TO BE USED WITH



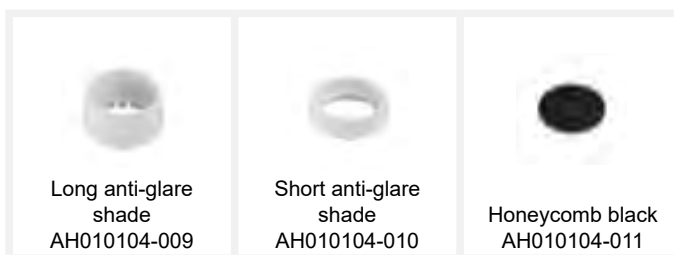

ACCESSORIES



DOT4 MODULE

4x4W 3000K CRI90 WHITE

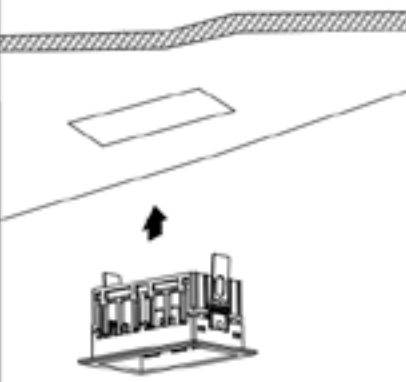
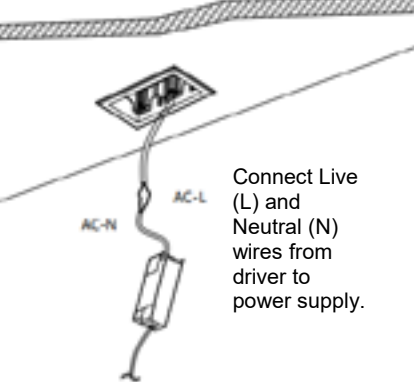
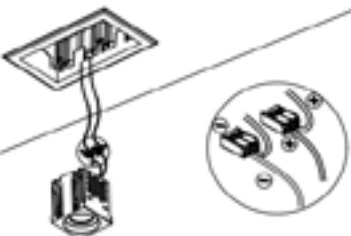
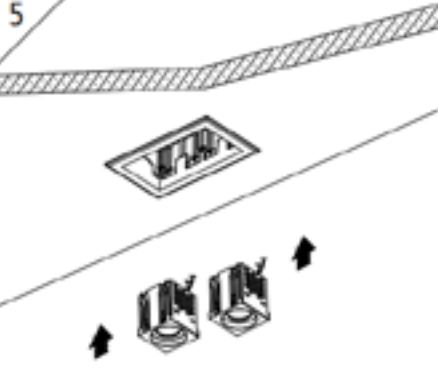
MANUAL

<p>1</p>  <p>Make sure the power is off before installation; Then make a suitable cut hole in the ceiling.</p>	<p>2 Pull up the springs and push the frame into the cut hole in ceiling.</p> 	<p>3</p>  <p>Connect Live (L) and Neutral (N) wires from driver to power supply.</p>
<p>4</p>  <p>Connect the Positive (+) and Negative(-) wires from the driver to the fixture accordingly.</p>	<p>5</p>  <p>Make sure the lock slot of the fixture aligns with the frame's slot and then slightly push it inside the frame.</p>	<p>6</p>  <p>First slot done. Installation complete; Power</p> <p>7</p>  <p>To remove the modules, push the module up for another 2 slots and the module will be released.</p>