

# PV2 R40 2 BASE PVC

## ΠΕΡΙΕΧΟΜΕΝΑ / CONTENTS

Datasheet.....1  
Manual.....4

SKU: PV2B240PC-XX-XX-XX-XX-XX-XX-XX-XX-XX

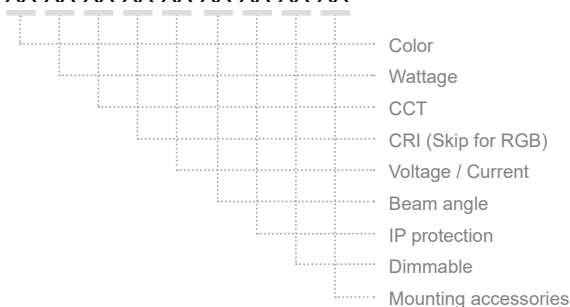

## DATASHEET

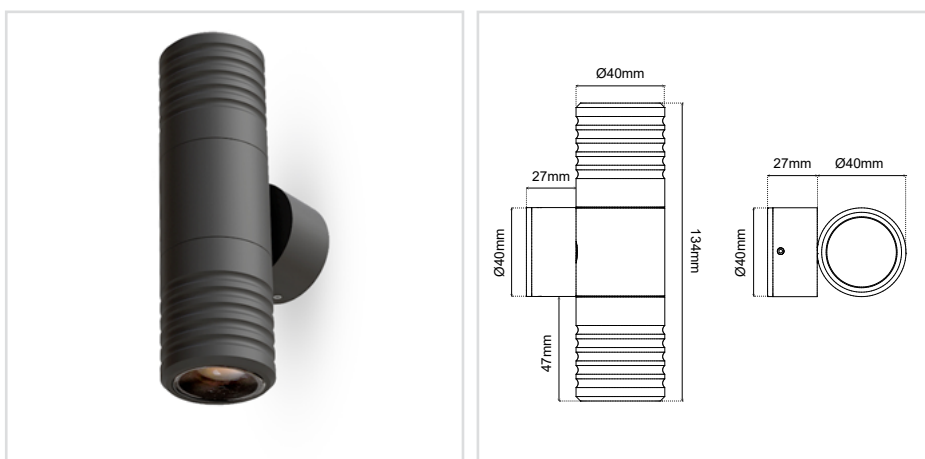









### GENERAL INFORMATION











APPLICATION	Outdoor / Surface mounted
DIRECTION OF MOUNTING	Ceiling / Wall / Ground
MATERIAL	PVC
VISIBLE DIMENSIONS (Ø×L)	Ø40 × 134 mm
INCL. CABLE	Yes
LED TYPE	XTE / XRE / XPE / NICHIA
LIFE TIME	50000 hours
WARRANTY	3–5 years (*5 years upon request)
ORIGIN	Greece

# PV2 R40 2 BASE PVC DATASHEET

SKU: PV2B240PC - XX-XX-XX-XX-XX-XX-XX-XX-XX

COLOR  
WATTAGE  
CCT  
CRI (skip for RGB)  
VOLTAGE / CURRENT  
BEAM ANGLE  
IP PROTECTION  
EXTRAS  
DIMMABLE

Color	Wattage*	CCT*	CRI*	Output	Voltage / Current*
None (gray) (NO) 	2 × 0.5W (1W)	2200K (22K) 	Ra80 (80)	70 lm/W	12VDC (V1)
	2 × 1W (2W)		Ra90 (90)	56lm/W	24VDC (V2)
Patina (PT) 	2 × 2W (4W)	2700K (27K) 	Ra80 (80)	100 lm/W	230VAC (V3)
	2 × 2.5W (5W)		Ra90 (90)	80 lm/W	
	2 × 3W (6W)	3000K (30K) 	Ra80 (80)	110 lm/W	12/24V (V4)
	2 × 4W (8W)		Ra90 (90)	88 lm/W	350mA (V5)
	4000K (40K) 	5000K (50K) 	Ra80 (80)	120 lm/W	500mA (V6)
			Ra90 (90)	96 lm/W	
6000K (60K) 	RGB (C1) 	Ra80 (80)	125 lm/W		
		Ra90 (90)	100 lm/W		

Beam Angle*	IP*	Extras	Dimmable*
Diffuse (DF) 	IP20 (20)	Honeycomb (HC) 	Dim (D)
10D (10D) 			
20D (20D) 	IP65 (65)	Shadow PVC (SH04) 	No Dim ( )
25D (25D) 	IP66 (66)		
36D (36D) 	IP67 (67)		
40D (40D) 		On-off switch (ONF) 	
60D (60D) 			
25×45D (2545D) 			

\* Υποχρεωτική επιλογή / Mandatory option

Δημιουργία Κωδικού προϊόντος / Product Code generator

PV2B240PC - color - wattage - CCT - CRI - voltage - beam angle - IP - extras - dimmable

EXAMPLE:

PV2B240PC-NO-6W-27K-90-V1-15D-65-SH04-HC-D

for PV2 R40 2 BASE PVC, none (gray), 2 × 3W, 2700K, Ra90, 12VDC, 15D, IP65, shadow PVC and honeycomb, dimmable)

# PV2 R40 2 BASE PVC DATASHEET

## LIGHT DISTRIBUTION

8D

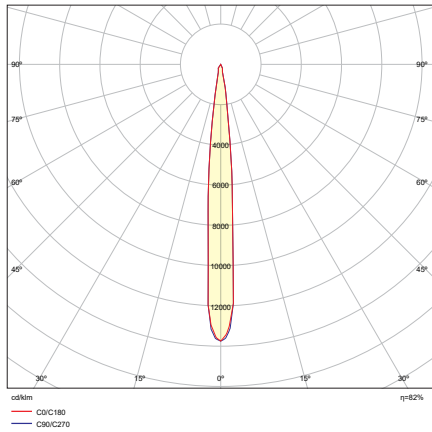

15D

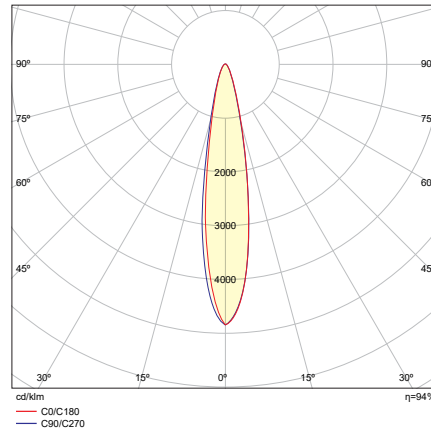

20D

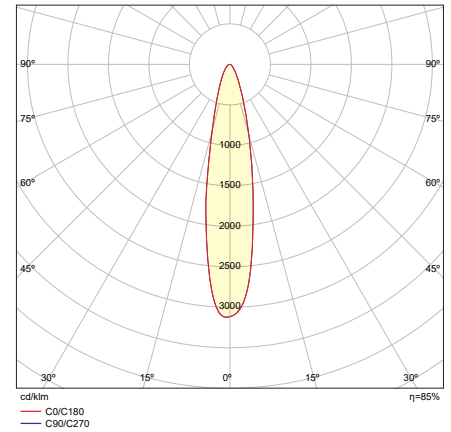

35D

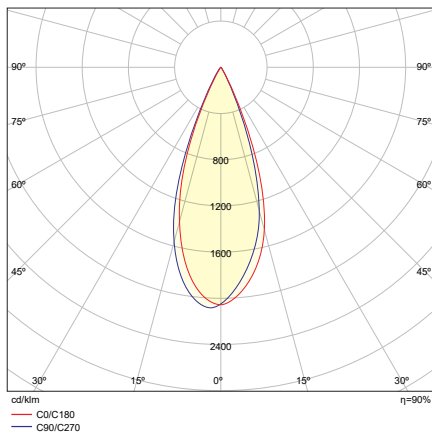

40D

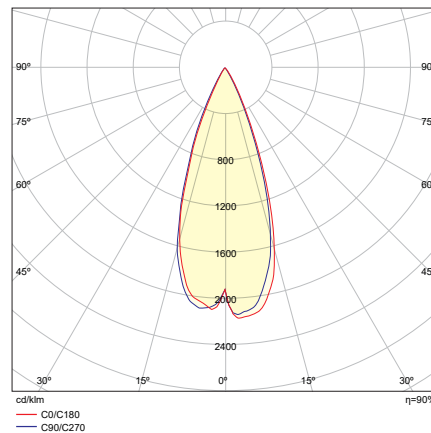

60D

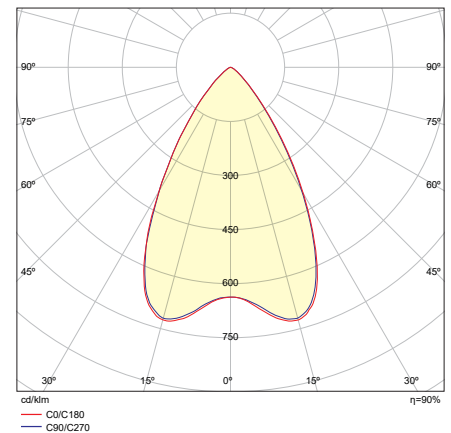

80D

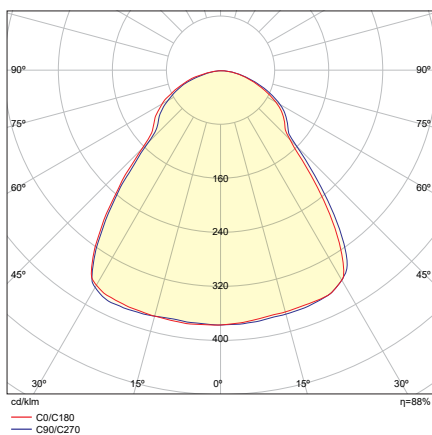

DIFFUSED

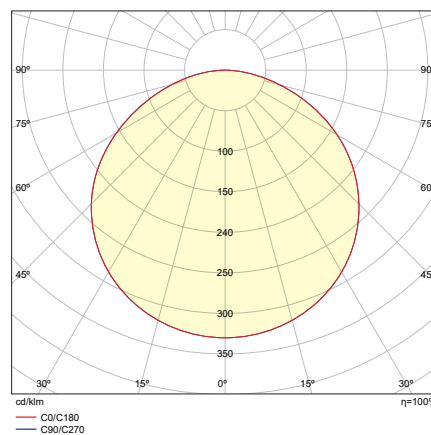

## PV2 R40 2 BASE PVC MANUAL

### ΟΔΗΓΙΕΣ ΕΓΚΑΤΑΣΤΑΣΗΣ INSTALLATION INSTRUCTIONS

#### ΣΗΜΑΝΤΙΚΟ:

Αυτό το εξάρτημα πρέπει να εγκατασταθεί από εξειδικευμένο ηλεκτρολόγο.

Η BarisLight δεν φέρει ευθύνη για τυχόν ζητήματα που προκύπτουν από ακατάλληλη εγκατάσταση που δεν συμμορφώνεται με τα τοπικά πρότυπα ασφαλείας.

Παρακαλούμε δώστε ένα αντίγραφο αυτών των οδηγιών στο άτομο που είναι υπεύθυνο για τη συντήρηση της εγκατάστασης.

#### IMPORTANT:

This luminaire must be installed by a qualified electrician.

#### Disclaimer:

BarisLight is not liable for any issues arising from improper installation that does not comply with local safety standards.

#### Instructions:

Please provide a copy of these instructions to the person responsible for maintaining the installation.

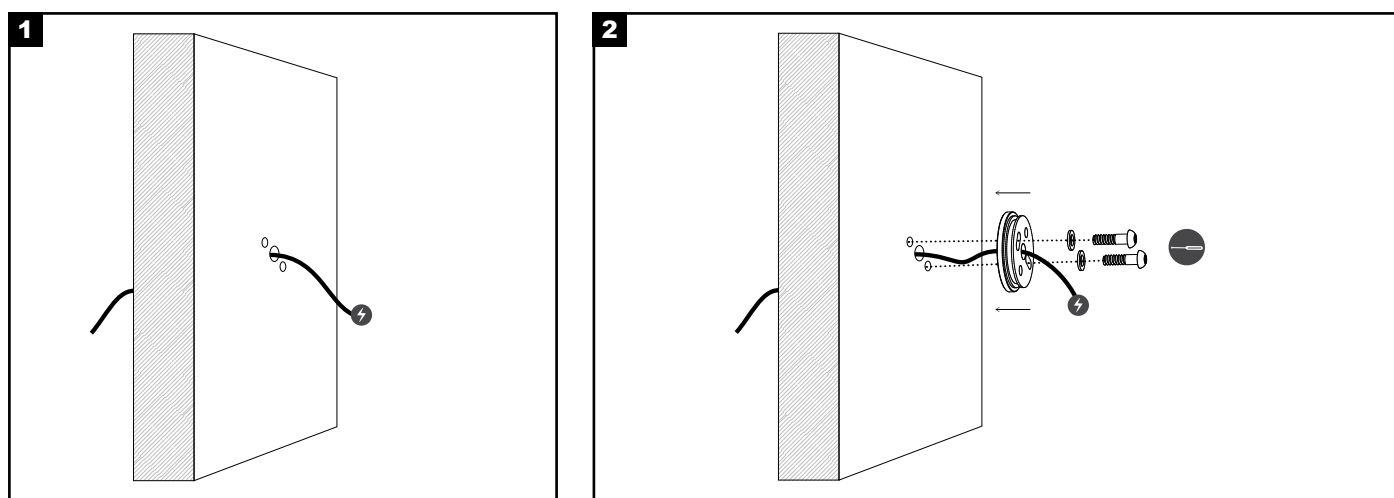

### 3 Σύνδεση με την ηλεκτρική παροχή Connection to the electrical supply

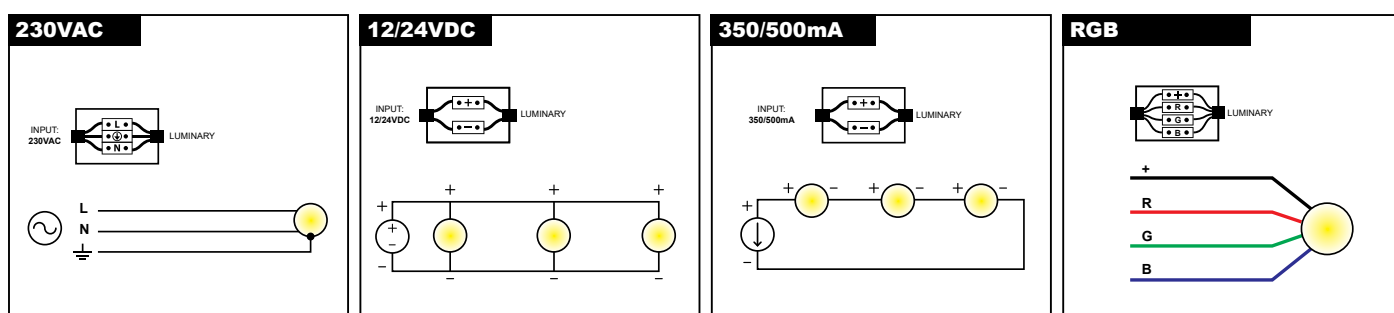

#### Διαδικασία καλωδίωσης

1. Κλείστε τον κεντρικό διακόπτη ρεύματος.
2. Συνδέστε τα φωτιστικά στη μονάδα παροχής ρεύματος.
3. Συνδέστε τη μονάδα τροφοδοσίας στο ηλεκτρικό δίκτυο.
4. Ενεργοποιήστε τον κεντρικό διακόπτη ρεύματος.

**Σημείωση ασφαλείας:** Βεβαιωθείτε ότι ο κεντρικός διακόπτης λειτουργίας είναι απενεργοποιημένος κατά τη διάρκεια όλων των διαδικασιών συντήρησης και εγκατάστασης.

**Προειδοποίηση:** Αποφύγετε τη σύνδεση πάρα πολλών φωτιστικών παράλληλα σε μία μόνο μονάδα τροφοδοσίας για να αποφευχθεί η υπερφόρτωση.

#### Wiring Procedure

1. Turn off the main power switch.
2. Connect the luminaires to the power supply unit.
3. Connect the power supply unit to the electrical network.
4. Turn on the main power switch.

**Safety Notice:** Ensure the main power switch is turned off during all maintenance and installation procedures.

**Warning:** Avoid connecting too many luminaires in parallel to a single power supply unit to prevent overloading.

## PV2 R40 2 BASE PVC MANUAL

