

TRIMLESS FRAME FOR 3 MODULES

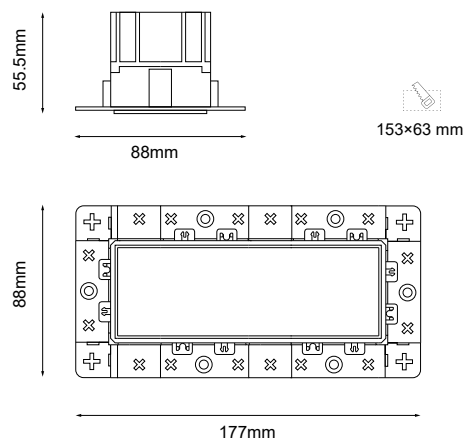







SKU: AH010104-004



GENERAL INFORMATION

APPLICATION	Recessed Trimless
DIRECTION OF MOUNTING	Ceiling
MATERIAL	Aluminium / PC
COLOR	White
VISIBLE DIMENSIONS (H×W×L)	55.5 × 177 × 88 mm
CUT-OUT DIMENSIONS (W×L)	153 × 63 mm
ORIGIN	China

TO BE USED WITH

 <p>DOT2 MODULE 2×4W 3000K CRI90 DALI WHITE AH010104-001</p>	 <p>SPOT MODULE 5W 3000K CRI90 WHITE AH010104-005</p>	 <p>EMPTY MODULE COVER WITHOUT LIGHT AH010104-006</p>
 <p>Trimless Frame for 1 Module AH010104-003</p>	 <p>Trimless Frame for 2 Modules AH010104-002</p>	 <p>Trimless Frame for 4 Modules AH010104-007</p>

TRIMLESS FRAME FOR 3 MODULES

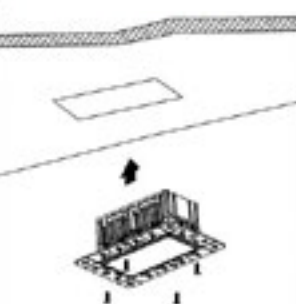
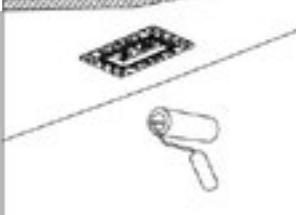
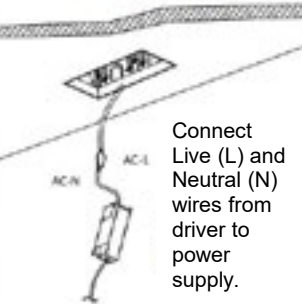
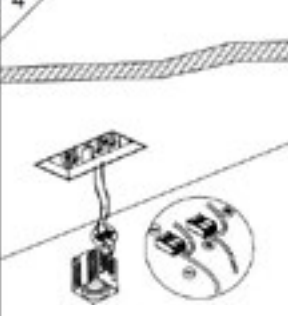
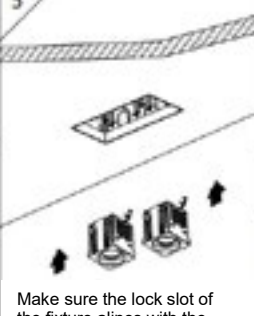
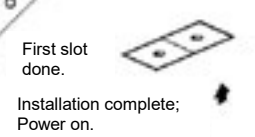
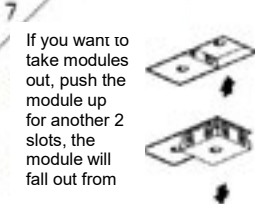
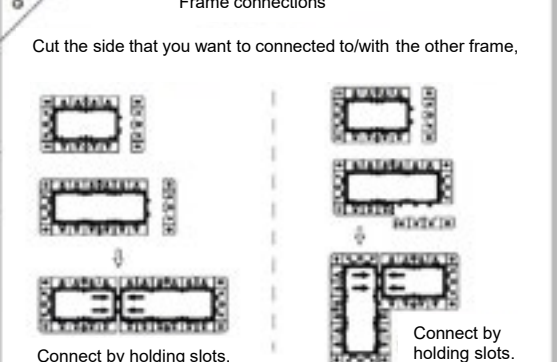
<p>1</p>  <p>153x63 mm</p> <p>Make sure power is off before installation; Then make suitable cut hole in the ceiling.</p>	<p>2</p> <p>Put the frame into the cut hole and secure the frame by screws.</p> 	<p>3</p> <p>Paint the ceiling after the frame is secured by screws.</p> 	<p>3</p> <p>Connect Live (L) and Neutral (N) wires from driver to power supply.</p> 
<p>4</p>  <p>Connect the Positive (+) and Negative(-) wires from the driver</p>	<p>5</p>  <p>Make sure the lock slot of the fixture aligns with the frame's slot and then slightly</p>	<p>6</p> <p>First slot done. Installation complete; Power on.</p>  <p>7</p> <p>If you want to take modules out, push the module up for another 2 slots, the module will fall out from</p> 	<p>8</p> <p>Frame connections</p> <p>Cut the side that you want to connected to/with the other frame,</p>  <p>Connect by holding slots.</p> <p>Connect by holding slots.</p>