



CATALOG 2024

LINEAR LIGHTING SYSTEMS

ΓΡΑΜΜΙΚΑ ΣΥΣΤΗΜΑΤΑ



light. our passion is



Έκθεση: Ελ. Βενιζέλου και Βύρωνος, 26333 Πάτρα
Βιοτεχνία: Γλαύκου 83, 26332 Πάτρα



2610 317 313
2610 317 300



barislight.eu
b2b.barislight.eu



info@barislight.eu



Baris Light

Linear lighting systems

ΠΕΡΙΕΧΟΜΕΝΑ / CONTENTS

χωρευτά / recessed

Linear
trimless 30×15mm



Gila
trimless 35×35



Lena
trimless 55×35



Dark Lena
trimless 55×35



Nile
recessed 55×80



Dark Nile
recessed 55×80



επίτοιχα / surface mounted

Gila
surface 35×35



Lena
surface 55×35



Dark Lena
surface 55×35



Ganges
surface 55×60



Linear
surface 55×70



Dark Linear
surface 55×70



Nile
surface 55×80



κρεμαστά / suspended

Gila
suspended 35×35



Rhine suspended
37×60 flat



Rhine suspended
37×60 oval



Lena
suspended 55×35



Dark Lena
suspended 55×35



pg. 66

Ganges
suspended 55×60



pg.68

Linear
suspended 55×70



pg. 72

Dark Linear
suspended 55×70



pg. 75

Nile
suspended 55×80



pg. 78

Updown

Linear
updown 55×70



pg. 84

Dark Linear
updown 55×70



pg. 88

κύκλοι / circles

Circle
trimless 55×100



pg. 94

Circle
surface 55×100



pg. 98

Circle
suspended 55×100



pg. 102

Ειδικές κατασκευές / Special constructions

Καμπύλες / Curves

pg. 106

Συνδυασμός Diffuse - Dark / Diffuse - Dark combination

pg. 110

Πλακέτες Tunable 2700K-6500K / Tunable 2700K-6500K modules

pg. 112

Blu2Light® wireless light management system

pg. 114

Εγγύηση / Warranty

pg.116

Σήμανση καταλόγου / Catalogue indication

pg.118



XΩNEYTA / RECESSED

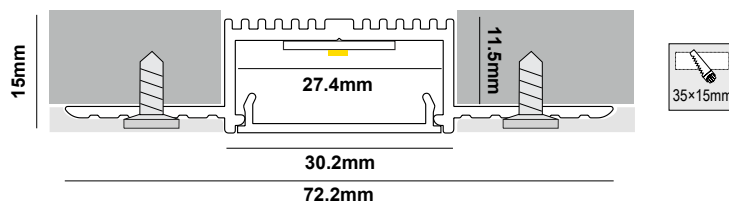

T3015-TR - XX - XXX - XXX - X

- (a)
Κωδικός Γραμμικού
Linear Code
- (b)
Κατηγορία
Category
- (c)
Μήκος
Length
- (d)
Θερμοκρασία
φωτός
Color
Temperature
- (f)
Αυξομείωση
έντασης φωτός
Dimming

Παράδειγμα κωδικού / Code example

LINEAR TRIMLESS 30×15, 1A, 85cm, 3000K, Dimmable
SKU: T3015-TR-1A-85cm-30K-D

Material	PCB details	CRI	Lumen output / W
Extruded aluminium	Zhaga-Compliant Dimensions	Ra>80 (Ra>90 on request)	up to 195 Lm/W

Covers	CCT	Dimming options (D)
<p>Click Diffuser 1.5mm (up to 70m reel)</p>	3000K (30K)	Push
	4000K (40K)	DALI
	5000K (50K)	TRIAC 0/1-10V
	6500K (65K)	CASAMBI
	TUNABLE 2700K - 6500K (TN)	Analog 0/1-10V

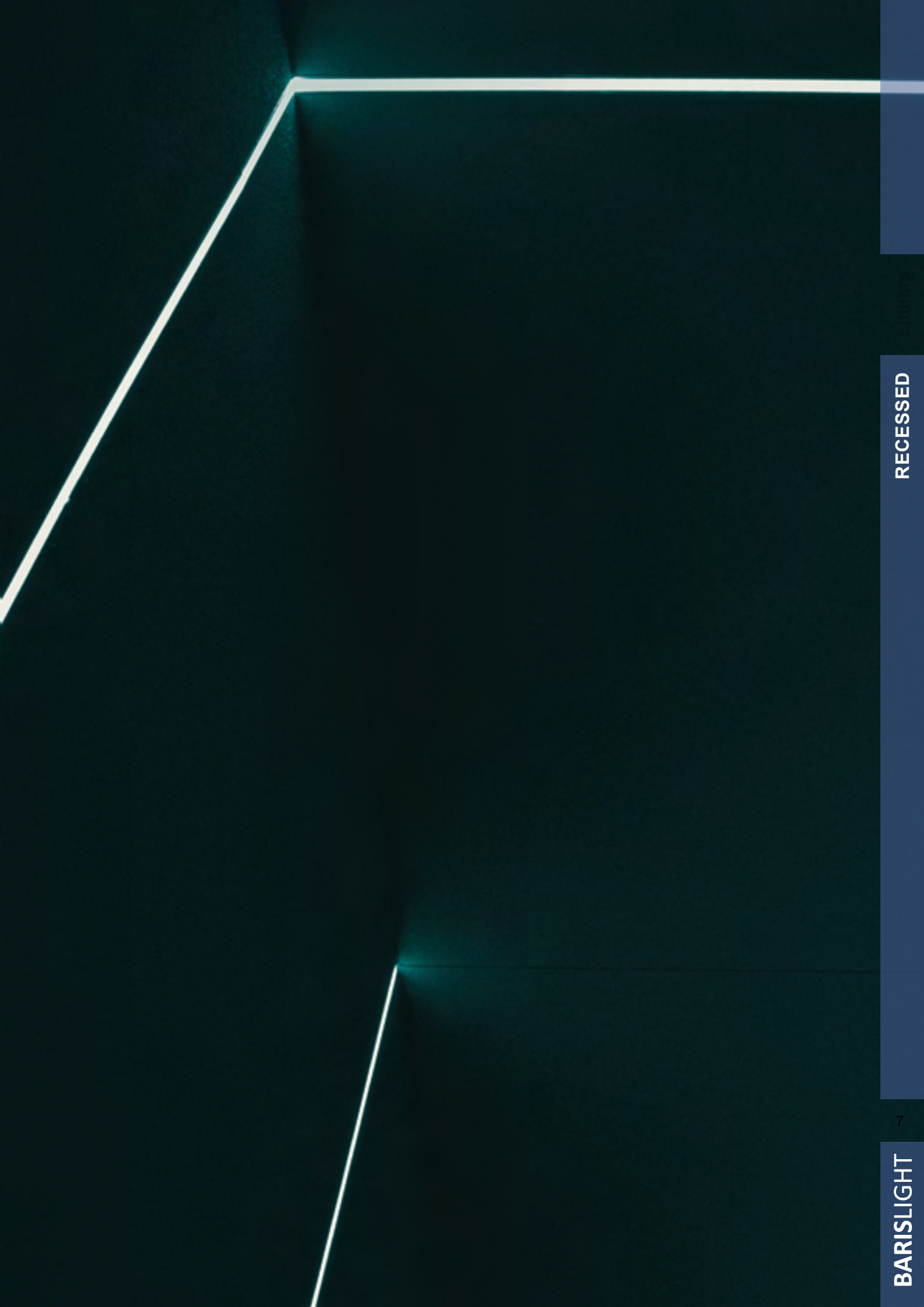

RECESSED

7

BARISLIGHT

LINEAR TRIMLESS 30×15 / Lumen output tables

CATEGORY 1A 350mA (1A)	SKU	Length	Wattage	Lumens 3000K	Lumens 4000K	Lumens 5000K	Lumens 6500K
	T3015-TR-1A-57cm	57cm	7.8	1390	1470	1470	1440
	T3015-TR-1A-85cm	85cm	11.7	2085	2205	2205	2160
	T3015-TR-1A-113cm	113cm	15.6	2780	2940	2940	2880
	T3015-TR-1A-141cm	141cm	19.5	3475	3675	3675	3600
	T3015-TR-1A-169cm	57cm	23.4	4170	4410	4410	4320
	T3015-TR-1A-197cm	85cm	27.3	4865	5145	5145	5040
	T3015-TR-1A-225cm	113cm	31.2	5560	5880	5880	5760
	T3015-TR-1A-253cm	141cm	35.1	6255	6615	6615	6480
	T3015-TR-1A-281cm	281cm	39	6950	7350	7350	7200
	T3015-TR-1A-309cm	309cm	42.9	7645	8085	8085	7920
	T3015-TR-1A-337cm	337cm	46.8	8340	8820	8820	8640
	T3015-TR-1A-365cm	365cm	50.7	9035	9555	9555	9360
	T3015-TR-1A-393cm	393cm	54.6	9730	10290	10290	10080
	T3015-TR-1A-421cm	421cm	58.5	10425	11025	11025	10800
T3015-TR-1A-449cm	449cm	62.4	11120	11760	11760	11520	

Wattage: 13.5 W/m

CATEGORY 1B 500mA (1B)	T3015-TR-1B-57cm	57cm	11.6	1960	2070	2070	2020
	T3015-TR-1B-85cm	85cm	17.4	2940	3105	3105	3030
	T3015-TR-1B-113cm	113cm	23.2	3920	4140	4140	4040
	T3015-TR-1B-141cm	141cm	29	4900	5175	5175	5050
	T3015-TR-1B-169cm	169cm	34.8	5880	6210	6210	6060
	T3015-TR-1B-197cm	197cm	40.6	6860	7245	7245	7070
	T3015-TR-1B-225cm	225cm	46.4	7840	8280	8280	8080
	T3015-TR-1B-253cm	253cm	52.2	8820	9315	9315	9090
	T3015-TR-1B-281cm	281cm	58	9800	10350	10350	10100
	T3015-TR-1B-309cm	309cm	63.8	10780	11385	11385	11110
	T3015-TR-1B-337cm	337cm	69.6	11760	12420	12420	12120
	T3015-TR-1B-365cm	365cm	75.4	12740	13455	13455	13130
	T3015-TR-1B-393cm	393cm	81.2	13720	14490	14490	14140
	T3015-TR-1B-421cm	421cm	87	14700	15525	15525	15150
	T3015-TR-1B-449cm	449cm	92.8	15680	16560	16560	16160

Wattage: 20 W/m

Το φωτιστικό είναι διαθέσιμο σε μήκος πολλαπλάσιο των 14 εκατοστών

The illuminant is available in lengths that are multiples of 14 centimeters.

LINEAR TRIMLESS 30×15 / Lumen output tables

CATEGORY 2A 350mA (2A)	SKU	Length	Wattage	Lumens 3000K	Lumens 4000K	Lumens 5000K	Lumens 6500K
	T3015-TR-2A-57cm	57cm	23.6	4080	4380	4380	4080
	T3015-TR-2A-85cm	85cm	35.4	6120	6570	6570	6120
	T3015-TR-2A-113cm	113cm	47.2	8160	8760	8760	8160
	T3015-TR-2A-141cm	141cm	59	10200	10950	10950	10200
	T3015-TR-2A-169cm	169cm	70.8	12240	13140	13140	12240
	T3015-TR-2A-197cm	197cm	82.6	14280	15330	15330	14280
	T3015-TR-2A-225cm	225cm	94.4	16320	17520	17520	16320
	T3015-TR-2A-253cm	253cm	106.2	18360	19710	19710	18360
	T3015-TR-2A-281cm	281cm	118	20400	21900	21900	20400
	T3015-TR-2A-309cm	309cm	129.8	22440	24090	24090	22440
	T3015-TR-2A-337cm	337cm	141.6	24480	26280	26280	24480
	T3015-TR-2A-365cm	365cm	153.4	26520	28470	28470	26520
	T3015-TR-2A-393cm	393cm	165.2	28560	30660	30660	28560
	T3015-TR-2A-421cm	421cm	177	30600	32850	32850	30600
T3015-TR-2A-449cm	449cm	188.8	32640	35040	35040	32640	

Wattage: 40.5 W/m

CATEGORY 2B 500mA (2B)	T3015-TR-2B-57cm	57cm	35	5700	6140	6140	5700
	T3015-TR-2B-85cm	85cm	52.5	8550	9210	9210	8550
	T3015-TR-2B-113cm	113cm	70	11400	12280	12280	11400
	T3015-TR-2B-141cm	141cm	87.5	14250	15350	15350	14250
	T3015-TR-2B-169cm	169cm	105	17100	18420	18420	17100
	T3015-TR-2B-197cm	197cm	122.5	19950	21490	21490	19950
	T3015-TR-2B-225cm	225cm	140	22800	24560	24560	22800
	T3015-TR-2B-253cm	253cm	157.5	25650	27630	27630	25650
	T3015-TR-2B-281cm	281cm	175	28500	30700	30700	28500
	T3015-TR-2B-309cm	309cm	192.5	31350	33770	33770	31350
	T3015-TR-2B-337cm	337cm	210	34200	36840	36840	34200
	T3015-TR-2B-365cm	365cm	227.5	37050	39910	39910	37050
	T3015-TR-2B-393cm	393cm	245	39900	42980	42980	39900
	T3015-TR-2B-421cm	421cm	262.5	42750	46050	46050	42750
	T3015-TR-2B-449cm	449cm	280	45600	49120	49120	45600

Wattage: 60.5 W/m

Το φωτιστικό είναι διαθέσιμο σε μήκος πολλαπλάσιο των 14 εκατοστών
 The illuminant is available in lengths that are multiples of 14 centimeters.

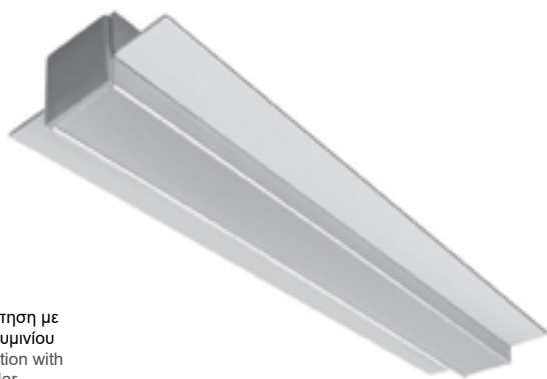

(M)
 χωνευτή τοποθέτηση με
 γωνιόκρανο αλουμινίου
 Trimless Installation with
 aluminium angular

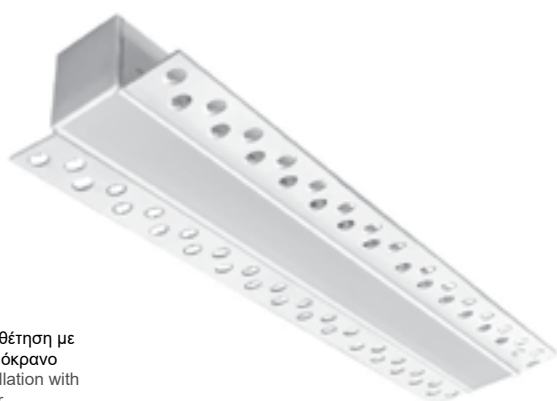
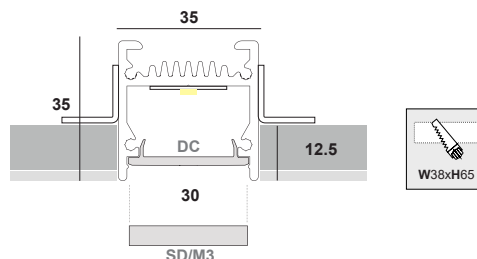

(P)
 χωνευτή τοποθέτηση με
 πλαστικό γωνιόκρανο
 Trimless Installation with
 plastic angular

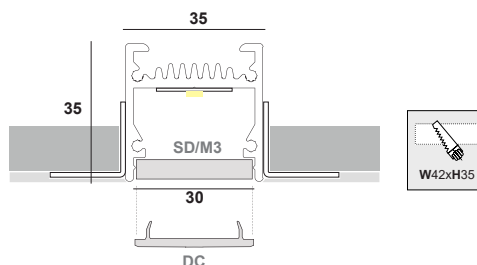

T35-TR - XX - XXX - XXX - XX - X - X

(a)	(b)	(c)	(d)	(e)	(f)	(g)
Κωδικός Γραμμικού Linear Code	Κατηγορία Category	Μήκος Length	Θερμοκρασία φωτός Color Temperature	Κάλυμμα Cover	Αυξομείωση έντασης φωτός Dimming	Χωνευτή τοποθέτηση Trimless installation

Παράδειγμα κωδικού / Code example

GILA TRIMLESS 35x35, 1A, 87cm, 3000K, Click Diffuser 1.5mm, Dimmable, with Plastic Angular
 SKU: T35-TR-1A-87cm-30K-DC-D-P

Material	PCB details	CRI	Lumen output / W
Extruded aluminium	Zhaga-Compliant Dimensions	Ra>80 (Ra>90 on request)	up to 195 Lm/W

Covers	CCT	Dimming options (D)
Click Diffuser 1.5mm (up to 70m reel) (DC)	3000K (30K)	Push
	4000K (40K)	DALI
	5000K (50K)	TRIAC 0/1-10V
Click Diffuser 3mm (DC1)	6500K (65K)	CASAMBI
	TUNABLE 2700K - 6500K (TN)	Analog 0/1-10V
Click Diffuser 5mm (SD)		
Microprismatic (M3)		



GILA TRIMLESS 35×35 / Lumen output tables

CATEGORY 1A 350mA (1A)	SKU	Length	Wattage	Lumens 3000K	Lumens 4000K	Lumens 5000K	Lumens 6500K
	T35-TR-1A-59cm	59cm	7.8	1390	1470	1470	1440
	T35-TR-1A-87cm	87cm	11.7	2085	2205	2205	2160
	T35-TR-1A-115cm	115cm	15.6	2780	2940	2940	2880
	T35-TR-1A-143cm	143cm	19.5	3475	3675	3675	3600
	T35-TR-1A-171cm	171cm	23.4	4170	4410	4410	4320
	T35-TR-1A-199cm	199cm	27.3	4865	5145	5145	5040
	T35-TR-1A-227cm	227cm	31.2	5560	5880	5880	5760
	T35-TR-1A-255cm	255cm	35.1	6255	6615	6615	6480
	T35-TR-1A-283cm	283cm	39	6950	7350	7350	7200
	T35-TR-1A-311cm	311cm	42.9	7645	8085	8085	7920
	T35-TR-1A-339cm	339cm	46.8	8340	8820	8820	8640
	T35-TR-1A-367cm	367cm	50.7	9035	9555	9555	9360
	T35-TR-1A-395cm	395cm	54.6	9730	10290	10290	10080
	T35-TR-1A-423cm	423cm	58.5	10425	11025	11025	10800
T35-TR-1A-451cm	451cm	62.4	11120	11760	11760	11520	

Wattage: 13.5 W/m

CATEGORY 1B 500mA (1B)	SKU	Length	Wattage	Lumens 3000K	Lumens 4000K	Lumens 5000K	Lumens 6500K
	T35-TR-1B-59cm	59cm	11.6	1960	2070	2070	2020
	T35-TR-1B-87cm	87cm	17.4	2940	3105	3105	3030
	T35-TR-1B-115cm	115cm	23.2	3920	4140	4140	4040
	T35-TR-1B-143cm	143cm	29	4900	5175	5175	5050
	T35-TR-1B-171cm	171cm	34.8	5880	6210	6210	6060
	T35-TR-1B-199cm	199cm	40.6	6860	7245	7245	7070
	T35-TR-1B-227cm	227cm	46.4	7840	8280	8280	8080
	T35-TR-1B-255cm	255cm	52.2	8820	9315	9315	9090
	T35-TR-1B-283cm	283cm	58	9800	10350	10350	10100
	T35-TR-1B-311cm	311cm	63.8	10780	11385	11385	11110
	T35-TR-1B-339cm	339cm	69.6	11760	12420	12420	12120
	T35-TR-1B-367cm	367cm	75.4	12740	13455	13455	13130
	T35-TR-1B-395cm	395cm	81.2	13720	14490	14490	14140
	T35-TR-1B-423cm	423cm	87	14700	15525	15525	15150
T35-TR-1B-451cm	451cm	92.8	15680	16560	16560	16160	

Wattage: 20 W/m

Το φωτιστικό είναι διαθέσιμο σε μήκος πολλαπλάσιο των 14 εκατοστών

The illuminant is available in lengths that are multiples of 14 centimeters.

GILA TRIMLESS 35×35 / Lumen output tables

CATEGORY 2A 350mA (2A)	SKU	Length	Wattage	Lumens 3000K	Lumens 4000K	Lumens 5000K	Lumens 6500K
	T35-TR-2A-59cm	59cm	23.6	4080	4380	4380	4080
	T35-TR-2A-87cm	87cm	35.4	6120	6570	6570	6120
	T35-TR-2A-115cm	115cm	47.2	8160	8760	8760	8160
	T35-TR-2A-143cm	143cm	59	10200	10950	10950	10200
	T35-TR-2A-171cm	171cm	70.8	12240	13140	13140	12240
	T35-TR-2A-199cm	199cm	82.6	14280	15330	15330	14280
	T35-TR-2A-227cm	227cm	94.4	16320	17520	17520	16320
	T35-TR-2A-255cm	255cm	106.2	18360	19710	19710	18360
	T35-TR-2A-283cm	283cm	118	20400	21900	21900	20400
	T35-TR-2A-311cm	311cm	129.8	22440	24090	24090	22440
	T35-TR-2A-339cm	339cm	141.6	24480	26280	26280	24480
	T35-TR-2A-367cm	367cm	153.4	26520	28470	28470	26520
	T35-TR-2A-395cm	395cm	165.2	28560	30660	30660	28560
	T35-TR-2A-423cm	423cm	177	30600	32850	32850	30600
T35-TR-2A-451cm	451cm	188.8	32640	35040	35040	32640	

Wattage: 40.5 W/m

CATEGORY 2B 500mA (2B)	T35-TR-2B-59cm	59cm	35	5700	6140	6140	5700
	T35-TR-2B-87cm	87cm	52.5	8550	9210	9210	8550
	T35-TR-2B-115cm	115cm	70	11400	12280	12280	11400
	T35-TR-2B-143cm	143cm	87.5	14250	15350	15350	14250
	T35-TR-2B-171cm	171cm	105	17100	18420	18420	17100
	T35-TR-2B-199cm	199cm	122.5	19950	21490	21490	19950
	T35-TR-2B-227cm	227cm	140	22800	24560	24560	22800
	T35-TR-2B-255cm	255cm	157.5	25650	27630	27630	25650
	T35-TR-2B-283cm	283cm	175	28500	30700	30700	28500
	T35-TR-2B-311cm	311cm	192.5	31350	33770	33770	31350
	T35-TR-2B-339cm	339cm	210	34200	36840	36840	34200
	T35-TR-2B-367cm	367cm	227.5	37050	39910	39910	37050
	T35-TR-2B-395cm	395cm	245	39900	42980	42980	39900
	T35-TR-2B-423cm	423cm	262.5	42750	46050	46050	42750
	T35-TR-2B-451cm	451cm	280	45600	49120	49120	45600

Wattage: 60.5 W/m

Το φωτιστικό είναι διαθέσιμο σε μήκος πολλαπλάσιο των 14 εκατοστών

The illuminant is available in lengths that are multiples of 14 centimeters.



(M)
 χωνευτή τοποθέτηση με
 γωνιόκρανο αλουμινίου
 Trimless Installation with
 aluminium angular

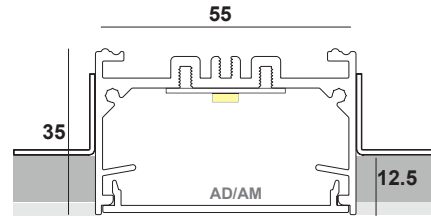

(P)
 χωνευτή τοποθέτηση με
 πλαστικό γωνιόκρανο
 Trimless Installation with
 plastic angular

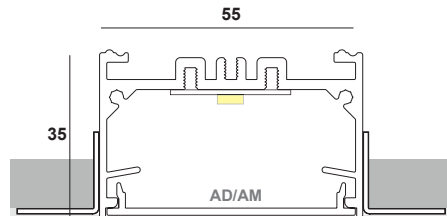



T5535-TR - XX - XX - XX - XX - X - X

(a)	(b)	(c)	(d)	(e)	(f)	(g)
Κωδικός Γραμμικού Linear Code	Κατηγορία Category	Μήκος Length	Θερμοκρασία φωτός Color Temperature	Κάλυμμα Cover	Αυξομείωση έντασης φωτός Dimming	Χωνευτή τοποθέτηση Trimless installation

Παράδειγμα κωδικού / Code example

LENA TRIMLESS 55x35, 1A, 85cm, 3000K, Acrylic Diffuser, Dimmable, with Plastic Angular
SKU: T5535-TR-1A-85cm-30K-AD-D-P

Material	PCB details	CRI	Lumen output / W
Extruded aluminium	Zhaga-Compliant Dimensions	Ra>80 (Ra>90 on request)	up to 195 Lm/W

Covers	CCT	Dimming options (D)
Acrylic Diffuser (AD) 	3000K (30K)	Push
	4000K (40K)	DALI
	5000K (50K)	TRIAC 0/1-10V
Acrylic Microprismatic (AM) 	6500K (65K)	CASAMBI
	TUNABLE 2700K - 6500K (TN)	Analog 0/1-10V



Linear

RECESSED

LENA TRIMLESS 55×35 / Lumen output tables

CATEGORY 1A 350mA (1A)	SKU	Length	Wattage	Lumens 3000K	Lumens 4000K	Lumens 5000K	Lumens 6500K
	T5535-TR-1A-57cm	57cm	7.8	1390	1470	1470	1440
	T5535-TR-1A-85cm	85cm	11.7	2085	2205	2205	2160
	T5535-TR-1A-113cm	113cm	15.6	2780	2940	2940	2880
	T5535-TR-1A-141cm	141cm	19.5	3475	3675	3675	3600
	T5535-TR-1A-169cm	169cm	23.4	4170	4410	4410	4320
	T5535-TR-1A-197cm	197cm	27.3	4865	5145	5145	5040
	T5535-TR-1A-225cm	225cm	31.2	5560	5880	5880	5760
	T5535-TR-1A-253cm	253cm	35.1	6255	6615	6615	6480
	T5535-TR-1A-281cm	281cm	39	6950	7350	7350	7200
	T5535-TR-1A-309cm	309cm	42.9	7645	8085	8085	7920
	T5535-TR-1A-337cm	337cm	46.8	8340	8820	8820	8640
	T5535-TR-1A-365cm	365cm	50.7	9035	9555	9555	9360
	T5535-TR-1A-393cm	393cm	54.6	9730	10290	10290	10080
	T5535-TR-1A-421cm	421cm	58.5	10425	11025	11025	10800
T5535-TR-1A-449cm	449cm	62.4	11120	11760	11760	11520	

Wattage: 13.5 W/m

CATEGORY 1B 500mA (1B)	T5535-TR-1B-57cm	57cm	11.6	1960	2070	2070	2020
	T5535-TR-1B-85cm	85cm	17.4	2940	3105	3105	3030
	T5535-TR-1B-113cm	113cm	23.2	3920	4140	4140	4040
	T5535-TR-1B-141cm	141cm	29	4900	5175	5175	5050
	T5535-TR-1B-169cm	169cm	34.8	5880	6210	6210	6060
	T5535-TR-1B-197cm	197cm	40.6	6860	7245	7245	7070
	T5535-TR-1B-225cm	225cm	46.4	7840	8280	8280	8080
	T5535-TR-1B-253cm	253cm	52.2	8820	9315	9315	9090
	T5535-TR-1B-281cm	281cm	58	9800	10350	10350	10100
	T5535-TR-1B-309cm	309cm	63.8	10780	11385	11385	11110
	T5535-TR-1B-337cm	337cm	69.6	11760	12420	12420	12120
	T5535-TR-1B-365cm	365cm	75.4	12740	13455	13455	13130
	T5535-TR-1B-393cm	393cm	81.2	13720	14490	14490	14140
	T5535-TR-1B-421cm	421cm	87	14700	15525	15525	15150
	T5535-TR-1B-449cm	449cm	92.8	15680	16560	16560	16160

Wattage: 20 W/m

Το φωτιστικό είναι διαθέσιμο σε μήκος πολλαπλάσιο των 14 εκατοστών

The illuminant is available in lengths that are multiples of 14 centimeters.

LENA TRIMLESS 55×35 / Lumen output tables

CATEGORY 2A 350mA (2A)	SKU	Length	Wattage	Lumens 3000K	Lumens 4000K	Lumens 5000K	Lumens 6500K
	T5535-TR-2A-57cm	57cm	23.6	4080	4380	4380	4080
	T5535-TR-2A-85cm	85cm	35.4	6120	6570	6570	6120
	T5535-TR-2A-113cm	113cm	47.2	8160	8760	8760	8160
	T5535-TR-2A-141cm	141cm	59	10200	10950	10950	10200
	T5535-TR-2A-169cm	169cm	70.8	12240	13140	13140	12240
	T5535-TR-2A-197cm	197cm	82.6	14280	15330	15330	14280
	T5535-TR-2A-225cm	225cm	94.4	16320	17520	17520	16320
	T5535-TR-2A-253cm	253cm	106.2	18360	19710	19710	18360
	T5535-TR-2A-281cm	281cm	118	20400	21900	21900	20400
	T5535-TR-2A-309cm	309cm	129.8	22440	24090	24090	22440
	T5535-TR-2A-337cm	337cm	141.6	24480	26280	26280	24480
	T5535-TR-2A-365cm	365cm	153.4	26520	28470	28470	26520
	T5535-TR-2A-393cm	393cm	165.2	28560	30660	30660	28560
	T5535-TR-2A-421cm	421cm	177	30600	32850	32850	30600
T5535-TR-2A-449cm	449cm	188.8	32640	35040	35040	32640	

Wattage: 40.5 W/m

CATEGORY 2B 500mA (2B)	T5535-TR-2B-57cm	57cm	35	5700	6140	6140	5700
	T5535-TR-2B-85cm	85cm	52.5	8550	9210	9210	8550
	T5535-TR-2B-113cm	113cm	70	11400	12280	12280	11400
	T5535-TR-2B-141cm	141cm	87.5	14250	15350	15350	14250
	T5535-TR-2B-169cm	169cm	105	17100	18420	18420	17100
	T5535-TR-2B-197cm	197cm	122.5	19950	21490	21490	19950
	T5535-TR-2B-225cm	225cm	140	22800	24560	24560	22800
	T5535-TR-2B-253cm	253cm	157.5	25650	27630	27630	25650
	T5535-TR-2B-281cm	281cm	175	28500	30700	30700	28500
	T5535-TR-2B-309cm	309cm	192.5	31350	33770	33770	31350
	T5535-TR-2B-337cm	337cm	210	34200	36840	36840	34200
	T5535-TR-2B-365cm	365cm	227.5	37050	39910	39910	37050
	T5535-TR-2B-393cm	393cm	245	39900	42980	42980	39900
	T5535-TR-2B-421cm	421cm	262.5	42750	46050	46050	42750
	T5535-TR-2B-449cm	449cm	280	45600	49120	49120	45600

Wattage: 60.5 W/m

Το φωτιστικό είναι διαθέσιμο σε μήκος πολλαπλάσιο των 14 εκατοστών
 The illuminant is available in lengths that are multiples of 14 centimeters.

DARK LENA TRIMLESS 55×35 (TD5535-TR)

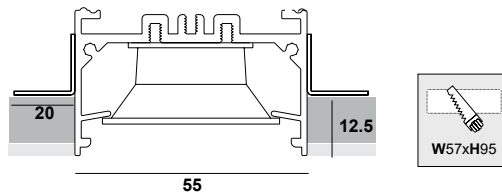

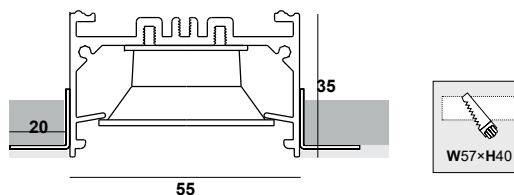

(M)
 χωνευτή τοποθέτηση με
 γωνιόκρανο αλουμινίου
 Trimless Installation with
 aluminium angular



(P)
 χωνευτή τοποθέτηση με
 πλαστικό γωνιόκρανο
 Trimless Installation with
 plastic angular

Material	PCB details	CRI	Lumen output / W
Extruded aluminium / Plastic	SMD light & dark 7×1	Ra>90 (Ra>80 on request)	up to 205 Lm/W

CCT	Beam angle	Reflector color	Dimming options (D)
3000K (30K)	Medium 65D (65D)	 Black (1)	Push
4000K (40K)	Wide 90D (90D)		DALI
5000K (50K)		 White (2)	TRIAC 0/1-10V
6500K (65K)			CASAMBI
TUNABLE 2700K - 6500K (TN)			Analog 0/1-10V

DARK LENA TRIMLESS 55×35 / Lumen output tables

CATEGORY 1A 350mA (1A)	SKU	Length	Wattage	Lumens 3000K (65D)	Lumens 3000K (90D)	Lumens 4000K (65D)	Lumens 4000K (90D)
	TD5535-TR-1A-56.5cm	56.5cm	13.4	1702	1680	1774	1752
	TD5535-TR-1A-84.5cm	84.5cm	20.1	2553	2520	2661	2628
	TD5535-TR-1A-112.5cm	112.5cm	26.8	3404	3360	3548	3504
	TD5535-TR-1A-140.5cm	140.5cm	33.5	4255	4200	4435	4380
	TD5535-TR-1A-168.5cm	168.5cm	40.2	5106	5040	5322	5256
	TD5535-TR-1A-196.5cm	196.5cm	46.9	5957	5880	6209	6132
	TD5535-TR-1A-224.5cm	224.5cm	53.6	6808	6720	7096	7008
	TD5535-TR-1A-252.5cm	252.5cm	60.3	7659	7560	7983	7884
	TD5535-TR-1A-280.5cm	280.5cm	67	8510	8400	8870	8760
	TD5535-TR-1A-308.5cm	308.5cm	73.7	9361	9240	9757	9636
	TD5535-TR-1A-336.5cm	336.5cm	80.4	10212	10080	10644	10512
	TD5535-TR-1A-364.5cm	364.5cm	87.1	11063	10920	11531	11388
	TD5535-TR-1A-392.5cm	392.5cm	93.8	11914	11760	12418	12264
	TD5535-TR-1A-420.5cm	420.5cm	100.5	12765	12600	13305	13140
TD5535-TR-1A-448.5cm	448.5cm	107.2	13616	13440	14192	14016	

Wattage: 23 W/m

CATEGORY 1B 500mA (1B)	SKU	Length	Wattage	Lumens 3000K (65D)	Lumens 3000K (90D)	Lumens 4000K (65D)	Lumens 4000K (90D)
	TD5535-TR-1B-56.5cm	56.5cm	19.8	2398	2368	2512	2480
	TD5535-TR-1B-84.5cm	84.5cm	29.7	3597	3552	3768	3720
	TD5535-TR-1B-112.5cm	112.5cm	39.6	4796	4736	5024	4960
	TD5535-TR-1B-140.5cm	140.5cm	49.5	5995	5920	6280	6200
	TD5535-TR-1B-168.5cm	168.5cm	59.4	7194	7104	7536	7440
	TD5535-TR-1B-196.5cm	196.5cm	69.3	8393	8288	8792	8680
	TD5535-TR-1B-224.5cm	224.5cm	79.2	9592	9472	10048	9920
	TD5535-TR-1B-252.5cm	252.5cm	89.1	10791	10656	11304	11160
	TD5535-TR-1B-280.5cm	280.5cm	99	11990	11840	12560	12400
	TD5535-TR-1B-308.5cm	308.5cm	108.9	13189	13024	13816	13640
	TD5535-TR-1B-336.5cm	336.5cm	118.8	14388	14208	15072	14880
	TD5535-TR-1B-364.5cm	364.5cm	128.7	15587	15392	16328	16120
	TD5535-TR-1B-392.5cm	392.5cm	138.6	16786	16576	17584	17360
	TD5535-TR-1B-420.5cm	420.5cm	148.5	17985	17760	18840	18600
TD5535-TR-1B-448.5cm	448.5cm	158.4	19184	18944	20096	19840	

Wattage: 34 W/m

Το φωτιστικό είναι διαθέσιμο σε μήκος πολλαπλάσιο των 28 εκατοστών

The illuminant is available in lengths that are multiples of 28 centimeters.

TD5535-TR - XX - XX - XX - XX - X - X - X

(a)

(b)

(c)

(d)

(e)

(f)

(g)

(h)

Κωδικός Γραμμικού
Linear Code

Κατηγορία
Category

Μήκος
Length

Θερμοκρασία
φωτός
Color
Temperature

Γωνία Δέσμης
Beam Angle

Χρώμα
Ρεφλέκτορα
Reflector
Color

Αυξομείωση
έντασης
φωτός
Dimming

Χωνευτή
τοποθέτηση
Trimless
installation

Παράδειγμα κωδικού / Code example

DARK LENA TRIMLESS 55×35, 1A, 84.5cm, 3000K, 65D, Black Reflector, Dimmable, with Plastic Angular
SKU: TD5535-TR-1A-84.5cm-30K-65D-1-D-P

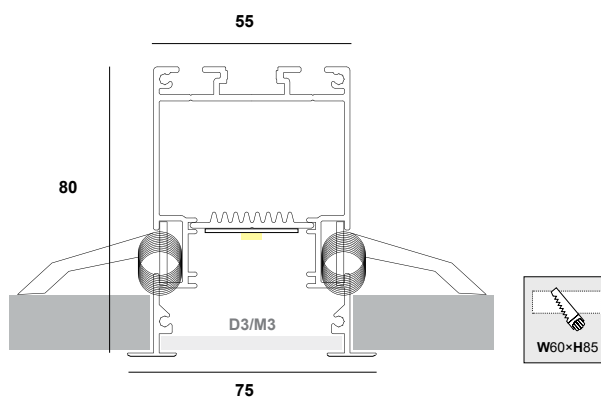

T5580-RCS - XX - XX - XX - XX - XX - X



(a)	(b)	(c)	(d)	(e)	(e)	(f)
Κωδικός Γραμμικού Linear Code	Κατηγορία Category	Μήκος Length	Θερμοκρασία φωτός Color Temperature	Χρώμα προφίλ Profile Color	Κάλυμμα Cover	Αυξομείωση έντασης φωτός Dimming

Παράδειγμα κωδικού / Code example

NILE RECESSED 55×80, 1A, 85cm, 3000K, Black, Diffuser, Dimmable

SKU: T5580-RCS-1A-85cm-30K-BL-D3-D

Material	PCB details	CRI	Lumen output / W
Extruded aluminium	Zhaga-Compliant Dimensions	Ra>80 (Ra>90 on request)	up to 195 Lm/W

Covers	Profile color	CCT	Dimming options (D)
Diffuser 3mm (D3) 	Anodized (AN)	3000K (30K)	Push
	Black (BL)	4000K (40K)	DALI
	White (WH)	5000K (50K)	TRIAC 0/1-10V
Microprismatic 3mm (M3) 	RAL (RL)	6500K (65K)	CASAMBI
	Graphite (GF)	TUNABLE 2700K - 6500K (TN)	Analog 0/1-10V
	Nickeling (NK)		
	Patina (PT)		



Linears

RECESSED

21

BARISLIGHT

NILE RECESSED 55×80 / Lumen output tables

CATEGORY 1A 350mA (1A)	SKU	Length	Wattage	Lumens 3000K	Lumens 4000K	Lumens 5000K	Lumens 6500K
	T5580-RCS-1A-57cm	57cm	7.8	1390	1470	1470	1440
	T5580-RCS-1A-85cm	85cm	11.7	2085	2205	2205	2160
	T5580-RCS-1A-113cm	113cm	15.6	2780	2940	2940	2880
	T5580-RCS-1A-141cm	141cm	19.5	3475	3675	3675	3600
	T5580-RCS-1A-169cm	169cm	23.4	4170	4410	4410	4320
	T5580-RCS-1A-197cm	197cm	27.3	4865	5145	5145	5040
	T5580-RCS-1A-225cm	225cm	31.2	5560	5880	5880	5760
	T5580-RCS-1A-253cm	253cm	35.1	6255	6615	6615	6480
	T5580-RCS-1A-281cm	281cm	39	6950	7350	7350	7200
	T5580-RCS-1A-309cm	309cm	42.9	7645	8085	8085	7920
	T5580-RCS-1A-337cm	337cm	46.8	8340	8820	8820	8640
	T5580-RCS-1A-365cm	365cm	50.7	9035	9555	9555	9360
	T5580-RCS-1A-393cm	393cm	54.6	9730	10290	10290	10080
T5580-RCS-1A-421cm	421cm	58.5	10425	11025	11025	10800	
T5580-RCS-1A-449cm	449cm	62.4	11120	11760	11760	11520	

Wattage: 13.5 W/m

CATEGORY 1B 500mA (1B)	T5580-RCS-1B-57cm	57cm	11.6	1960	2070	2070	2020
	T5580-RCS-1B-85cm	85cm	17.4	2940	3105	3105	3030
	T5580-RCS-1B-113cm	113cm	23.2	3920	4140	4140	4040
	T5580-RCS-1B-141cm	141cm	29	4900	5175	5175	5050
	T5580-RCS-1B-169cm	169cm	34.8	5880	6210	6210	6060
	T5580-RCS-1B-197cm	197cm	40.6	6860	7245	7245	7070
	T5580-RCS-1B-225cm	225cm	46.4	7840	8280	8280	8080
	T5580-RCS-1B-253cm	253cm	52.2	8820	9315	9315	9090
	T5580-RCS-1B-281cm	281cm	58	9800	10350	10350	10100
	T5580-RCS-1B-309cm	309cm	63.8	10780	11385	11385	11110
	T5580-RCS-1B-337cm	337cm	69.6	11760	12420	12420	12120
	T5580-RCS-1B-365cm	365cm	75.4	12740	13455	13455	13130
	T5580-RCS-1B-393cm	393cm	81.2	13720	14490	14490	14140
	T5580-RCS-1B-421cm	421cm	87	14700	15525	15525	15150
T5580-RCS-1B-449cm	449cm	92.8	15680	16560	16560	16160	

Wattage: 20 W/m

*Το φωτιστικό είναι διαθέσιμο σε μήκος πολλαπλάσιο των 14 εκατοστών
The illuminant is available in lengths that are multiples of 14 centimeters.*

NILE RECESSED 55×80 / Lumen output tables

CATEGORY 2A 350mA (2A)	SKU	Length	Wattage	Lumens 3000K	Lumens 4000K	Lumens 5000K	Lumens 6500K
	T5580-RCS-2A-57cm	57cm	23.6	4080	4380	4380	4080
	T5580-RCS-2A-85cm	85cm	35.4	6120	6570	6570	6120
	T5580-RCS-2A-113cm	113cm	47.2	8160	8760	8760	8160
	T5580-RCS-2A-141cm	141cm	59	10200	10950	10950	10200
	T5580-RCS-2A-169cm	169cm	70.8	12240	13140	13140	12240
	T5580-RCS-2A-197cm	197cm	82.6	14280	15330	15330	14280
	T5580-RCS-2A-225cm	225cm	94.4	16320	17520	17520	16320
	T5580-RCS-2A-253cm	253cm	106.2	18360	19710	19710	18360
	T5580-RCS-2A-281cm	281cm	118	20400	21900	21900	20400
	T5580-RCS-2A-309cm	309cm	129.8	22440	24090	24090	22440
	T5580-RCS-2A-337cm	337cm	141.6	24480	26280	26280	24480
	T5580-RCS-2A-365cm	365cm	153.4	26520	28470	28470	26520
	T5580-RCS-2A-393cm	393cm	165.2	28560	30660	30660	28560
	T5580-RCS-2A-421cm	421cm	177	30600	32850	32850	30600
T5580-RCS-2A-449cm	449cm	188.8	32640	35040	35040	32640	

Wattage: 40.5 W/m

CATEGORY 2B 500mA (2B)	T5580-RCS-2B-57cm	57cm	35	5700	6140	6140	5700
	T5580-RCS-2B-85cm	85cm	52.5	8550	9210	9210	8550
	T5580-RCS-2B-113cm	113cm	70	11400	12280	12280	11400
	T5580-RCS-2B-141cm	141cm	87.5	14250	15350	15350	14250
	T5580-RCS-2B-169cm	169cm	105	17100	18420	18420	17100
	T5580-RCS-2B-197cm	197cm	122.5	19950	21490	21490	19950
	T5580-RCS-2B-225cm	225cm	140	22800	24560	24560	22800
	T5580-RCS-2B-253cm	253cm	157.5	25650	27630	27630	25650
	T5580-RCS-2B-281cm	281cm	175	28500	30700	30700	28500
	T5580-RCS-2B-309cm	309cm	192.5	31350	33770	33770	31350
	T5580-RCS-2B-337cm	337cm	210	34200	36840	36840	34200
	T5580-RCS-2B-365cm	365cm	227.5	37050	39910	39910	37050
	T5580-RCS-2B-393cm	393cm	245	39900	42980	42980	39900
	T5580-RCS-2B-421cm	421cm	262.5	42750	46050	46050	42750
	T5580-RCS-2B-449cm	449cm	280	45600	49120	49120	45600

Wattage: 60.5 W/m

Το φωτιστικό είναι διαθέσιμο σε μήκος πολλαπλάσιο των 14 εκατοστών

The illuminant is available in lengths that are multiples of 14 centimeters.

DARK NILE RECESSED 55×80 (TD5580-RCS)

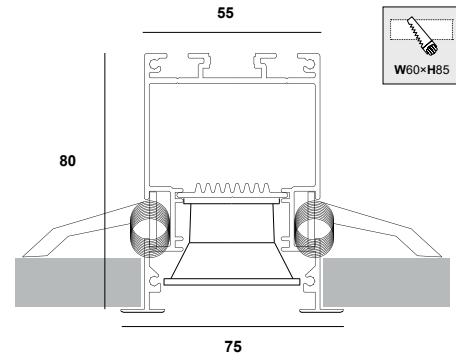

TD5580-RCS - XX - XX - XX - XX - XX - X - X

- (a)
Κωδικός Γραμμικού
Linear Code
- (b)
Κατηγορία
Category
- (c)
Μήκος
Length
- (d)
Θερμοκρασία
φωτός
Color
Temperature
- (e)
Γωνία Δέσμης
Beam Angle
- (f)
Χρώμα
προφίλ
Profile
Color
- (g)
Χρώμα
Ρεφλέκτορα
Reflector
Color
- (h)
Αυξομείωση
έντασης
φωτός
Dimming

Παράδειγμα κωδικού / Code example

DARK NILE RECESSED 55×80, 1A, 84.5cm, 3000K, 65D, Black, Black Reflector, Dimmable
SKU: TD5580-RCS-1A-84.5cm-30K-65D-BL-1-D

Material	PCB details	CRI	Lumen output / W
Extruded aluminium / Plastic	SMD light & dark 7×1	Ra>90 (Ra>80 on request)	up to 205 Lm/W

CCT	Beam angle	Profile color	Reflector color	Dimming options (D)
3000K (30K)	Medium 65D (65D)	Anodized (AN)	Black (1)	Push
4000K (40K)	Wide 90D (90D)	Black (BL)		DALI
5000K (50K)		White (WH)	White (2)	TRIAC 0/1-10V
6500K (65K)		RAL (RL)		CASAMBI
TUNABLE 2700K - 6500K (TN)		Graphite (GF)		Analog 0/1-10V
		Nickeling (NK)		
		Patina (PT)		

Εναλλακτική τοποθέτηση φακού / Alternative lens placement

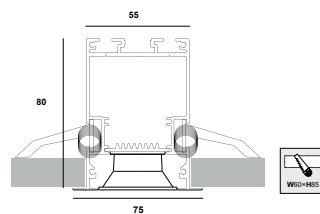

DARK NILE RECESSED 55×80 / Lumen output tables

CATEGORY 1A 350mA (1A)	SKU	Length	Wattage	Lumens 3000K (65D)	Lumens 3000K (90D)	Lumens 4000K (65D)	Lumens 4000K (90D)
	TD5580-RCS-1A-56.5cm	56.5cm	13.4	1702	1680	1774	1752
	TD5580-RCS-1A-84.5cm	84.5cm	20.1	2553	2520	2661	2628
	TD5580-RCS-1A-112.5cm	112.5cm	26.8	3404	3360	3548	3504
	TD5580-RCS-1A-140.5cm	140.5cm	33.5	4255	4200	4435	4380
	TD5580-RCS-1A-168.5cm	168.5cm	40.2	5106	5040	5322	5256
	TD5580-RCS-1A-196.5cm	196.5cm	46.9	5957	5880	6209	6132
	TD5580-RCS-1A-224.5cm	224.5cm	53.6	6808	6720	7096	7008
	TD5580-RCS-1A-252.5cm	252.5cm	60.3	7659	7560	7983	7884
	TD5580-RCS-1A-280.5cm	280.5cm	67	8510	8400	8870	8760
	TD5580-RCS-1A-308.5cm	308.5cm	73.7	9361	9240	9757	9636
	TD5580-RCS-1A-336.5cm	336.5cm	80.4	10212	10080	10644	10512
	TD5580-RCS-1A-364.5cm	364.5cm	87.1	11063	10920	11531	11388
	TD5580-RCS-1A-392.5cm	392.5cm	93.8	11914	11760	12418	12264
	TD5580-RCS-1A-420.5cm	420.5cm	100.5	12765	12600	13305	13140
TD5580-RCS-1A-448.5cm	448.5cm	107.2	13616	13440	14192	14016	

Wattage: 23 W/m

CATEGORY 1B 500mA (1B)	SKU	Length	Wattage	Lumens 3000K (65D)	Lumens 3000K (90D)	Lumens 4000K (65D)	Lumens 4000K (90D)
	TD5580-RCS-1B-56.5cm	56.5cm	19.8	2398	2368	2512	2480
	TD5580-RCS-1B-84.5cm	84.5cm	29.7	3597	3552	3768	3720
	TD5580-RCS-1B-112.5cm	112.5cm	39.6	4796	4736	5024	4960
	TD5580-RCS-1B-140.5cm	140.5cm	49.5	5995	5920	6280	6200
	TD5580-RCS-1B-168.5cm	168.5cm	59.4	7194	7104	7536	7440
	TD5580-RCS-1B-196.5cm	196.5cm	69.3	8393	8288	8792	8680
	TD5580-RCS-1B-224.5cm	224.5cm	79.2	9592	9472	10048	9920
	TD5580-RCS-1B-252.5cm	252.5cm	89.1	10791	10656	11304	11160
	TD5580-RCS-1B-280.5cm	280.5cm	99	11990	11840	12560	12400
	TD5580-RCS-1B-308.5cm	308.5cm	108.9	13189	13024	13816	13640
	TD5580-RCS-1B-336.5cm	336.5cm	118.8	14388	14208	15072	14880
	TD5580-RCS-1B-364.5cm	364.5cm	128.7	15587	15392	16328	16120
	TD5580-RCS-1B-392.5cm	392.5cm	138.6	16786	16576	17584	17360
	TD5580-RCS-1B-420.5cm	420.5cm	148.5	17985	17760	18840	18600
TD5580-RCS-1B-448.5cm	448.5cm	158.4	19184	18944	20096	19840	

Wattage: 34 W/m

Το φωτιστικό είναι διαθέσιμο σε μήκος πολλαπλάσιο των 28 εκατοστών

The illuminant is available in lengths that are multiples of 28 centimeters.



ΕΠΙΤΟΙΧΑ / SURFACE MOUNTED

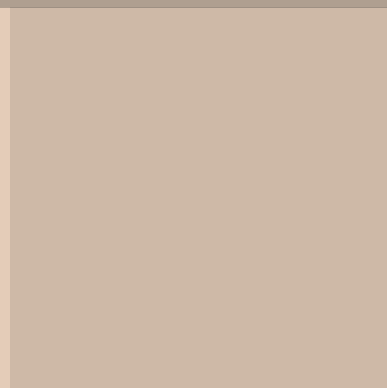

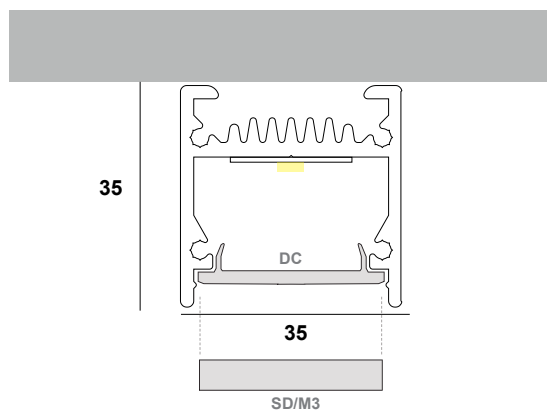
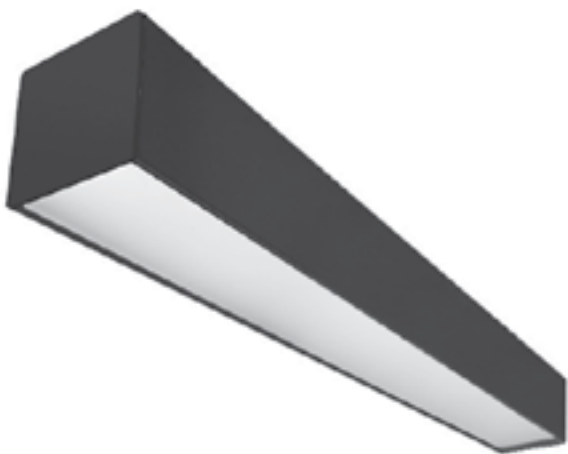

35-SF - XX - XX - X - XX - XX - X - XX

- (a)
Κωδικός
Γραμμικού
Linear Code
- (b)
Κατηγορία
Category
- (c)
Μήκος
Length
- (d)
Θερμοκρασία
φωτός
Color
Temperature
- (e)
Χρώμα
προφίλ
Profile
color
- (f)
Κάλυμμα
Cover
- (g)
Αυξομείωση
έντασης φωτός
Dimming
- (h)
Τοποθέτηση
τροφοδοτικού
Power supply
installation

Παράδειγμα κωδικού / Code example

GILA SURFACE 35×35, 1A, 88cm, 3000K, Black, with Slide Diffuser 5mm, Dimmable, Hidden power supply
SKU: 35-SF-1A-88cm-30K-BL-SD-D-HP

Material	PCB details	CRI	Lumen output / W
Extruded aluminium	Zhaga-Compliant Dimensions	Ra>80 (Ra>90 on request)	up to 195 Lm/W

Covers	Profile color	CCT	Dimming options (D)
Click Diffuser 1.5mm (up to 70m reel) (DC)	Anodized (AN)	3000K (30K)	Push
	Black (BL)	4000K (40K)	DALI
	White (WH)	5000K (50K)	TRIAC 0/1-10V
Click Diffuser 3mm (DC1)	RAL (RL)	6500K (65K)	CASAMBI
	Graphite (GF)	TUNABLE 2700K - 6500K (TN)	Analog 0/1-10V
Click Diffuser 5mm (SD)	Nickeling (NK)		
	Patina (PT)		
Microprismatic (M3)			

power supply installation

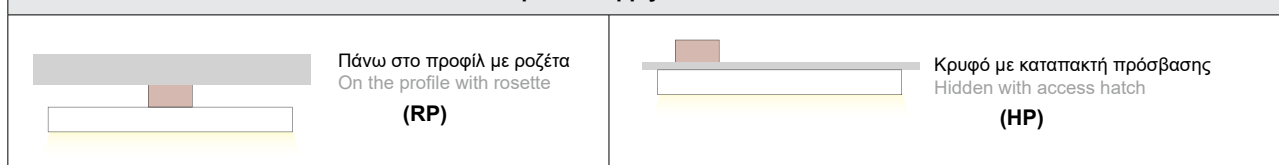



SURFACE MOUNTED

GILA SURFACE 35×35 / Lumen output tables

CATEGORY 1A 350mA (1A)	SKU	Length	Wattage	Lumens 3000K	Lumens 4000K	Lumens 5000K	Lumens 6500K
	35-SF-1A-60cm	60cm	7.8	1390	1470	1470	1440
	35-SF-1A-88cm	88cm	11.7	2085	2205	2205	2160
	35-SF-1A-116cm	116cm	15.6	2780	2940	2940	2880
	35-SF-1A-144cm	144cm	19.5	3475	3675	3675	3600
	35-SF-1A-173cm	173cm	23.4	4170	4410	4410	4320
	35-SF-1A-201cm	201cm	27.3	4865	5145	5145	5040
	35-SF-1A-229cm	229cm	31.2	5560	5880	5880	5760
	35-SF-1A-257cm	257cm	35.1	6255	6615	6615	6480
	35-SF-1A-285cm	285cm	39	6950	7350	7350	7200
	35-SF-1A-313cm	313cm	42.9	7645	8085	8085	7920
	35-SF-1A-342cm	342cm	46.8	8340	8820	8820	8640
	35-SF-1A-370cm	370cm	50.7	9035	9555	9555	9360
	35-SF-1A-399cm	399cm	54.6	9730	10290	10290	10080
	35-SF-1A-427cm	427cm	58.5	10425	11025	11025	10800
35-SF-1A-455cm	455cm	62.4	11120	11760	11760	11520	

Wattage: 13.5 W/m

CATEGORY 1B 500mA (1B)	SKU	Length	Wattage	Lumens 3000K	Lumens 4000K	Lumens 5000K	Lumens 6500K
	35-SF-1B-60cm	60cm	11.6	1960	2070	2070	2020
	35-SF-1B-88cm	88cm	17.4	2940	3105	3105	3030
	35-SF-1B-116cm	116cm	23.2	3920	4140	4140	4040
	35-SF-1B-144cm	144cm	29	4900	5175	5175	5050
	35-SF-1B-173cm	173cm	34.8	5880	6210	6210	6060
	35-SF-1B-201cm	201cm	40.6	6860	7245	7245	7070
	35-SF-1B-229cm	229cm	46.4	7840	8280	8280	8080
	35-SF-1B-257cm	257cm	52.2	8820	9315	9315	9090
	35-SF-1B-285cm	285cm	58	9800	10350	10350	10100
	35-SF-1B-313cm	313cm	63.8	10780	11385	11385	11110
	35-SF-1B-342cm	342cm	69.6	11760	12420	12420	12120
	35-SF-1B-370cm	370cm	75.4	12740	13455	13455	13130
	35-SF-1B-399cm	399cm	81.2	13720	14490	14490	14140
	35-SF-1B-427cm	427cm	87	14700	15525	15525	15150
35-SF-1B-455cm	455cm	92.8	15680	16560	16560	16160	

Wattage: 20 W/m

Το φωτιστικό είναι διαθέσιμο σε μήκος πολλαπλάσιο των 14 εκατοστών

The illuminant is available in lengths that are multiples of 14 centimeters.

GILA SURFACE 35×35 / Lumen output tables

CATEGORY 2A 350mA (2A)	SKU	Length	Wattage	Lumens 3000K	Lumens 4000K	Lumens 5000K	Lumens 6500K
	35-SF-2A-60cm	60cm	23.6	4080	4380	4380	4080
	35-SF-2A-88cm	88cm	35.4	6120	6570	6570	6120
	35-SF-2A-116cm	116cm	47.2	8160	8760	8760	8160
	35-SF-2A-144cm	144cm	59	10200	10950	10950	10200
	35-SF-2A-173cm	173cm	70.8	12240	13140	13140	12240
	35-SF-2A-201cm	201cm	82.6	14280	15330	15330	14280
	35-SF-2A-229cm	229cm	94.4	16320	17520	17520	16320
	35-SF-2A-257cm	257cm	106.2	18360	19710	19710	18360
	35-SF-2A-284cm	285cm	118	20400	21900	21900	20400
	35-SF-2A-313cm	313cm	129.8	22440	24090	24090	22440
	35-SF-2A-342cm	342cm	141.6	24480	26280	26280	24480
	35-SF-2A-370cm	370cm	153.4	26520	28470	28470	26520
	35-SF-2A-399cm	399cm	165.2	28560	30660	30660	28560
	35-SF-2A-427cm	427cm	177	30600	32850	32850	30600
35-SF-2A-455cm	455cm	188.8	32640	35040	35040	32640	

Wattage: 40.5 W/m

35-SF-2B-60cm	60cm	35	5700	6140	6140	5700
35-SF-2B-88cm	88cm	52.5	8550	9210	9210	8550
35-SF-2B-116cm	116cm	70	11400	12280	12280	11400
35-SF-2B-144cm	144cm	87.5	14250	15350	15350	14250
35-SF-2B-173cm	173cm	105	17100	18420	18420	17100
35-SF-2B-201cm	201cm	122.5	19950	21490	21490	19950
35-SF-2B-229cm	229cm	140	22800	24560	24560	22800
35-SF-2B-257cm	257cm	157.5	25650	27630	27630	25650
35-SF-2B-285cm	285cm	175	28500	30700	30700	28500
35-SF-2B-313cm	313cm	192.5	31350	33770	33770	31350
35-SF-2B-342cm	342cm	210	34200	36840	36840	34200
35-SF-2B-370cm	370cm	227.5	37050	39910	39910	37050
35-SF-2B-399cm	399cm	245	39900	42980	42980	39900
35-SF-2B-427cm	427cm	262.5	42750	46050	46050	42750
35-SF-2B-455cm	455cm	280	45600	49120	49120	45600

Wattage: 60.5 W/m

Το φωτιστικό είναι διαθέσιμο σε μήκος πολλαπλάσιο των 14 εκατοστών
 The illuminant is available in lengths that are multiples of 14 centimeters.

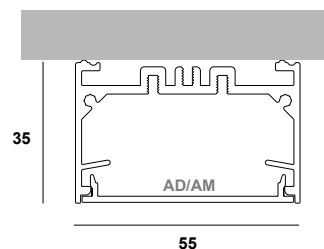

5535-SF - XX - XX - XX - XX - XX - X

(a)	(b)	(c)	(d)	(e)	(f)	(g)
Κωδικός Γραμμικού Linear Code	Κατηγορία Category	Μήκος Length	Θερμοκρασία φωτός Color Temperature	Χρώμα προφίλ Profile color	Κάλυμμα Cover	Αυτομείωση έντασης φωτός Dimming

Παράδειγμα κωδικού / Code example

LENA SURFACE 55×35, 1A, 85cm, 3000K, Black, with Acrylic Diffuser, Dimmable, Hidden power supply

SKU: 5535-SF-1A-85cm-30K-BL-AD-D-HP

Material	PCB details	CRI	Lumen output / W
Extruded aluminium	Zhaga-Compliant Dimensions	Ra>80 (Ra>90 on request)	up to 195 Lm/W

Covers	Profile color	CCT	Dimming options (D)
Acrylic Diffuser (AD)	Anodized (AN)	3000K (30K)	Push
	Black (BL)	4000K (40K)	DALI
	White (WH)	5000K (50K)	TRIAC 0/1-10V
Acrylic Microprismatic (AM)	RAL (RL)	6500K (65K)	CASAMBI
	Graphite (GF)	TUNABLE 2700K - 6500K (TN)	Analog 0/1-10V
	Nickeling (NK)		
	Patina (PT)		

power supply installation

<p>Πάνω στο προφίλ με ροζέτα On the profile with rosette (RP)</p>	<p>Δίπλα στο προφίλ To the side of the profile (RP1)</p>	<p>Κρυφό με καταπακτή πρόσβασης Hidden with access hatch (HP)</p>
--	---	--

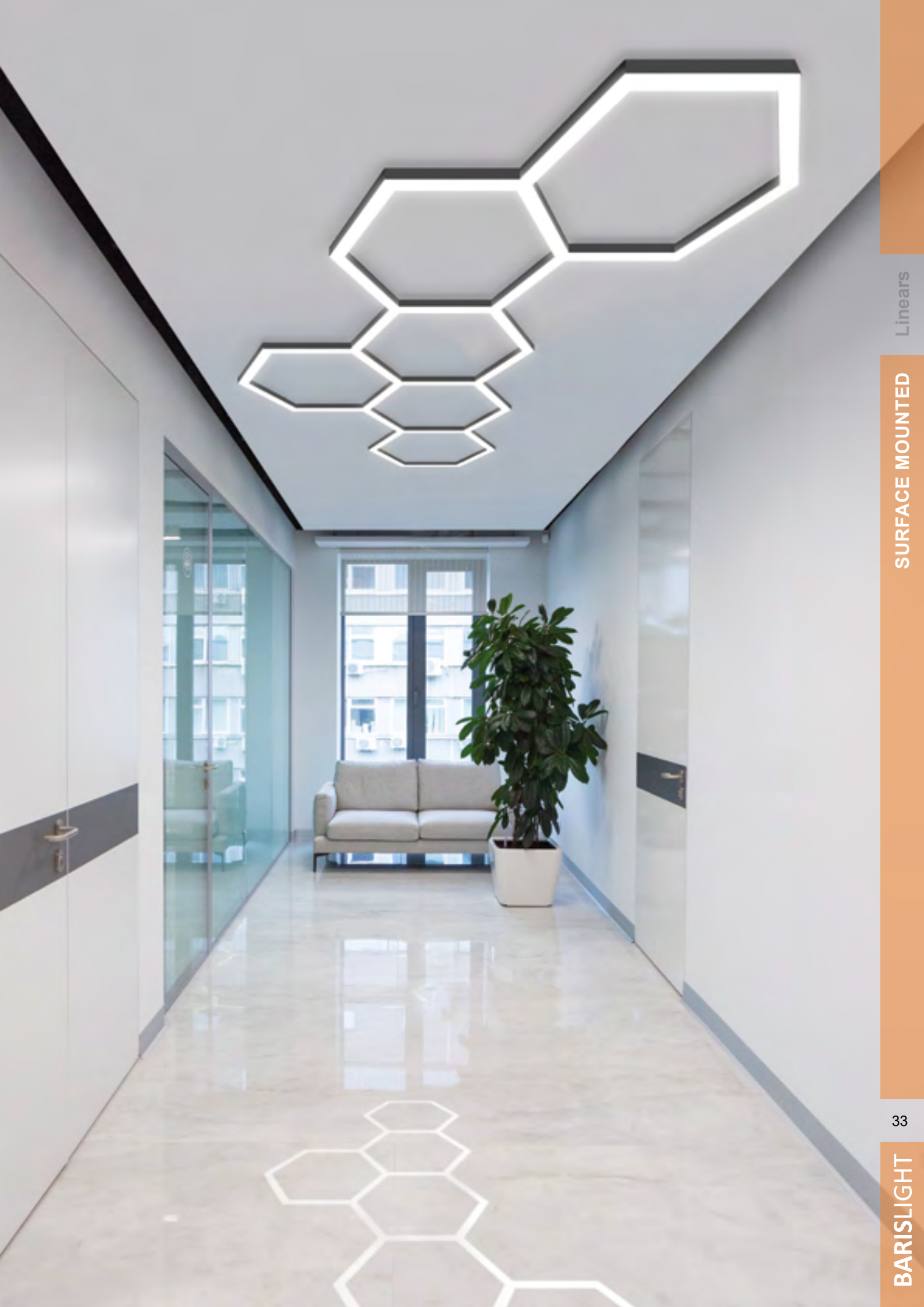

LENA SURFACE 55×35 / Lumen output tables

CATEGORY 1A 350mA (1A)	SKU	Length	Wattage	Lumens 3000K	Lumens 4000K	Lumens 5000K	Lumens 6500K
	5535-SF-1A-57cm	57cm	7.8	1390	1470	1470	1440
	5535-SF-1A-85cm	85cm	11.7	2085	2205	2205	2160
	5535-SF-1A-113cm	113cm	15.6	2780	2940	2940	2880
	5535-SF-1A-141cm	141cm	19.5	3475	3675	3675	3600
	5535-SF-1A-169cm	169cm	23.4	4170	4410	4410	4320
	5535-SF-1A-197cm	197cm	27.3	4865	5145	5145	5040
	5535-SF-1A-225cm	225cm	31.2	5560	5880	5880	5760
	5535-SF-1A-253cm	253cm	35.1	6255	6615	6615	6480
	5535-SF-1A-281cm	281cm	39	6950	7350	7350	7200
	5535-SF-1A-309cm	309cm	42.9	7645	8085	8085	7920
	5535-SF-1A-337cm	337cm	46.8	8340	8820	8820	8640
	5535-SF-1A-365cm	365cm	50.7	9035	9555	9555	9360
	5535-SF-1A-393cm	393cm	54.6	9730	10290	10290	10080
	5535-SF-1A-421cm	421cm	58.5	10425	11025	11025	10800
5535-SF-1A-449cm	449cm	62.4	11120	11760	11760	11520	

Wattage: 13.5 W/m

CATEGORY 1B 500mA (1B)	5535-SF-1B-57cm	57cm	11.6	1960	2070	2070	2020
	5535-SF-1B-85cm	85cm	17.4	2940	3105	3105	3030
	5535-SF-1B-113cm	113cm	23.2	3920	4140	4140	4040
	5535-SF-1B-141cm	141cm	29	4900	5175	5175	5050
	5535-SF-1B-169cm	169cm	34.8	5880	6210	6210	6060
	5535-SF-1B-197cm	197cm	40.6	6860	7245	7245	7070
	5535-SF-1B-225cm	225cm	46.4	7840	8280	8280	8080
	5535-SF-1B-253cm	253cm	52.2	8820	9315	9315	9090
	5535-SF-1B-281cm	281cm	58	9800	10350	10350	10100
	5535-SF-1B-309cm	309cm	63.8	10780	11385	11385	11110
	5535-SF-1B-337cm	337cm	69.6	11760	12420	12420	12120
	5535-SF-1B-365cm	365cm	75.4	12740	13455	13455	13130
	5535-SF-1B-393cm	393cm	81.2	13720	14490	14490	14140
	5535-SF-1B-421cm	421cm	87	14700	15525	15525	15150
	5535-SF-1B-449cm	449cm	92.8	15680	16560	16560	16160

Wattage: 20 W/m

Το φωτιστικό είναι διαθέσιμο σε μήκος πολλαπλάσιο των 14 εκατοστών

The illuminant is available in lengths that are multiples of 14 centimeters.

LENA SURFACE 55×35 / Lumen output tables

CATEGORY 2A 350mA (2A)	SKU	Length	Wattage	Lumens 3000K	Lumens 4000K	Lumens 5000K	Lumens 6500K
	5535-SF-2A-57cm	57cm	23.6	4080	4380	4380	4080
	5535-SF-2A-85cm	85cm	35.4	6120	6570	6570	6120
	5535-SF-2A-113cm	113cm	47.2	8160	8760	8760	8160
	5535-SF-2A-141cm	141cm	59	10200	10950	10950	10200
	5535-SF-2A-169cm	169cm	70.8	12240	13140	13140	12240
	5535-SF-2A-197cm	197cm	82.6	14280	15330	15330	14280
	5535-SF-2A-225cm	225cm	94.4	16320	17520	17520	16320
	5535-SF-2A-253cm	253cm	106.2	18360	19710	19710	18360
	5535-SF-2A-281cm	281cm	118	20400	21900	21900	20400
	5535-SF-2A-309cm	309cm	129.8	22440	24090	24090	22440
	5535-SF-2A-337cm	337cm	141.6	24480	26280	26280	24480
	5535-SF-2A-365cm	365cm	153.4	26520	28470	28470	26520
	5535-SF-2A-393cm	393cm	165.2	28560	30660	30660	28560
	5535-SF-2A-421cm	421cm	177	30600	32850	32850	30600
5535-SF-2A-449cm	449cm	188.8	32640	35040	35040	32640	

Wattage: 40.5 W/m

CATEGORY 2B 500mA (2B)	5535-SF-2B-57cm	57cm	35	5700	6140	6140	5700
	5535-SF-2B-85cm	85cm	52.5	8550	9210	9210	8550
	5535-SF-2B-113cm	113cm	70	11400	12280	12280	11400
	5535-SF-2B-141cm	141cm	87.5	14250	15350	15350	14250
	5535-SF-2B-169cm	169cm	105	17100	18420	18420	17100
	5535-SF-2B-197cm	197cm	122.5	19950	21490	21490	19950
	5535-SF-2B-225cm	225cm	140	22800	24560	24560	22800
	5535-SF-2B-253cm	253cm	157.5	25650	27630	27630	25650
	5535-SF-2B-281cm	281cm	175	28500	30700	30700	28500
	5535-SF-2B-309cm	309cm	192.5	31350	33770	33770	31350
	5535-SF-2B-337cm	337cm	210	34200	36840	36840	34200
	5535-SF-2B-365cm	365cm	227.5	37050	39910	39910	37050
	5535-SF-2B-393cm	393cm	245	39900	42980	42980	39900
	5535-SF-2B-421cm	421cm	262.5	42750	46050	46050	42750
	5535-SF-2B-449cm	449cm	280	45600	49120	49120	45600

Wattage: 60.5 W/m

Το φωτιστικό είναι διαθέσιμο σε μήκος πολλαπλάσιο των 14 εκατοστών

The illuminant is available in lengths that are multiples of 14 centimeters.

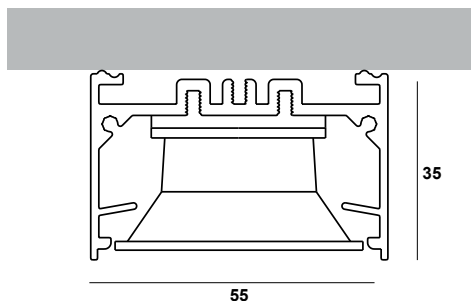

D5535-SF - XX - XX - XX - XX - XX - X - X - XX



(a)	(b)	(c)	(d)	(e)	(f)	(g)	(h)	(i)
Κωδικός Γραμμικού Linear Code	Κατηγορία Category	Μήκος Length	Θερμοκρασία φωτός Color Temperature	Γωνία Δέσμης Beam Angle	Χρώμα προφίλ Profile Color	Χρώμα Ρεφλέκτορα Reflector Color	Αυξομείωση έντασης φωτός Dimming	Τοποθέτηση τροφοδοτικού Power supply installation

Παράδειγμα κωδικού / Code example



DARK LENA SURFACE 55×35, 1A, 87cm, 3000K, 65D, Black, with Black Reflector, Dimmable, Hidden power supply

SKU: D5535-SF-1A-87cm-30K-65D-BL-1-D-HP

Material	PCB details	CRI	Lumen output / W
Extruded aluminium / Plastic	SMD light & dark 7×1	Ra>90 (Ra>80 on request)	up to 205 Lm/W

CCT	Beam angle	Profile color	Reflector color	Dimming options (D)
3000K (30K)	Medium 65D (65D)	Anodized (AN)	 Black (1)	Push
4000K (40K)		Black (BL)		DALI
5000K (50K)	Wide 90D (90D)	White (WH)	 White (2)	TRIAC 0/1-10V
6500K (65K)		RAL (RL)		CASAMBI
TUNABLE 2700K - 6500K (TN)		Graphite (GF)		Analog 0/1-10V
		Nickeling (NK)		
		Patina (PT)		

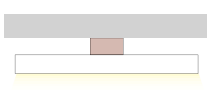
power supply installation

 <p>Πάνω στο προφίλ με ροζέτα On the profile with rosette (RP)</p>	 <p>Δίπλα στο προφίλ To the side of the profile (RP1)</p>	 <p>Κρυφό με καταπακτή πρόσβασης Hidden with access hatch (HP)</p>
--	---	--

DARK LENA SURFACE 55×35 / Lumen output tables

CATEGORY 1A 350mA (1A)	SKU	Length	Wattage	Lumens 3000K (65D)	Lumens 3000K (90D)	Lumens 4000K (65D)	Lumens 4000K (90D)
	D5535-SF-1A-59cm	59cm	13.4	1702	1680	1774	1752
	D5535-SF-1A-87cm	87cm	20.1	2553	2520	2661	2628
	D5535-SF-1A-115cm	115cm	26.8	3404	3360	3548	3504
	D5535-SF-1A-143cm	143cm	33.5	4255	4200	4435	4380
	D5535-SF-1A-171cm	171cm	40.2	5106	5040	5322	5256
	D5535-SF-1A-200.5cm	200.5cm	46.9	5957	5880	6209	6132
	D5535-SF-1A-228.5cm	228.5cm	53.6	6808	6720	7096	7008
	D5535-SF-1A-256.5cm	256.5cm	60.3	7659	7560	7983	7884
	D5535-SF-1A-284.5cm	284.5cm	67	8510	8400	8870	8760
	D5535-SF-1A-312.5cm	312.5cm	73.7	9361	9240	9757	9636
	D5535-SF-1A-340.5cm	340.5cm	80.4	10212	10080	10644	10512
	D5535-SF-1A-368.5cm	368.5cm	87.1	11063	10920	11531	11388
	D5535-SF-1A-396.5cm	396.5cm	93.8	11914	11760	12418	12264
	D5535-SF-1A-424.5cm	424.5cm	100.5	12765	12600	13305	13140
D5535-SF-1A-452.5cm	452.5cm	107.2	13616	13440	14192	14016	

Wattage: 23 W/m

CATEGORY 1B 500mA (1B)	D5535-SF-1B-59cm	59cm	19.8	2398	2368	2512	2480
	D5535-SF-1B-87cm	87cm	29.7	3597	3552	3768	3720
	D5535-SF-1B-115cm	115cm	39.6	4796	4736	5024	4960
	D5535-SF-1B-143cm	143cm	49.5	5995	5920	6280	6200
	D5535-SF-1B-171cm	171cm	59.4	7194	7104	7536	7440
	D5535-SF-1B-200.5cm	200.5cm	69.3	8393	8288	8792	8680
	D5535-SF-1B-228.5cm	228.5cm	79.2	9592	9472	10048	9920
	D5535-SF-1B-256.5cm	256.5cm	89.1	10791	10656	11304	11160
	D5535-SF-1B-284.5cm	284.5cm	99	11990	11840	12560	12400
	D5535-SF-1B-312.5cm	312.5cm	108.9	13189	13024	13816	13640
	D5535-SF-1B-340.5cm	340.5cm	118.8	14388	14208	15072	14880
	D5535-SF-1B-368.5cm	368.5cm	128.7	15587	15392	16328	16120
	D5535-SF-1B-396.5cm	396.5cm	138.6	16786	16576	17584	17360
	D5535-SF-1B-424.5cm	424.5cm	148.5	17985	17760	18840	18600
	D5535-SF-1B-452.5cm	452.5cm	158.4	19184	18944	20096	19840

Wattage: 34 W/m

Το φωτιστικό είναι διαθέσιμο σε μήκος πολλαπλάσιο των 28 εκατοστών

The illuminant is available in lengths that are multiples of 28 centimeters.

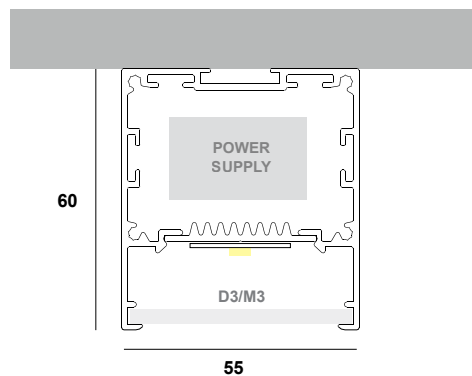

5560-SF - XX - XX - XX - XX - XX - X



(a)	(b)	(c)	(d)	(e)	(f)	(g)
Κωδικός Γραμμικού Linear Code	Κατηγορία Category	Μήκος Length	Θερμοκρασία φωτός Color Temperature	Χρώμα Color	Κάλυμμα Cover	Αυξομείωση έντασης φωτός Dimming

Παράδειγμα κωδικού / Code example

GANGES SURFACE 55×60, 1A, 85cm, 3000K, Black, with Diffuser, Dimmable

SKU: 5560-SF-1A-85cm-30K-BL-D3-D

Material	PCB details	CRI	Lumen output / W
Extruded aluminium	Zhaga-Compliant Dimensions	Ra>80 (Ra>90 on request)	up to 195 Lm/W

Covers	Profile color	CCT	Dimming options (D)
Diffuser 3mm (D3) 	Anodized (AN)	3000K (30K)	Push
	Black (BL)	4000K (40K)	DALI
	White (WH)	5000K (50K)	TRIAC 0/1-10V
Microprismatic 3mm (M3) 	RAL (RL)	6500K (65K)	CASAMBI
	Graphite (GF)	TUNABLE 2700K - 6500K (TN)	Analog 0/1-10V
	Nickeling (NK)		
	Patina (PT)		

GANGES SURFACE 55×60 / Lumen output tables

CATEGORY 1A 350mA (1A)	SKU	Length	Wattage	Lumens 3000K	Lumens 4000K	Lumens 5000K	Lumens 6500K
	5560-SF-1A-57cm	57cm	7.8	1390	1470	1470	1440
	5560-SF-1A-85cm	85cm	11.7	2085	2205	2205	2160
	5560-SF-1A-113cm	113cm	15.6	2780	2940	2940	2880
	5560-SF-1A-141cm	141cm	19.5	3475	3675	3675	3600
	5560-SF-1A-169cm	169cm	23.4	4170	4410	4410	4320
	5560-SF-1A-197cm	197cm	27.3	4865	5145	5145	5040
	5560-SF-1A-225cm	225cm	31.2	5560	5880	5880	5760
	5560-SF-1A-253cm	253cm	35.1	6255	6615	6615	6480
	5560-SF-1A-281cm	281cm	39	6950	7350	7350	7200
	5560-SF-1A-309cm	309cm	42.9	7645	8085	8085	7920
	5560-SF-1A-337cm	337cm	46.8	8340	8820	8820	8640
	5560-SF-1A-365cm	365cm	50.7	9035	9555	9555	9360
	5560-SF-1A-393cm	393cm	54.6	9730	10290	10290	10080
	5560-SF-1A-421cm	421cm	58.5	10425	11025	11025	10800
5560-SF-1A-449cm	449cm	62.4	11120	11760	11760	11520	

Wattage: 13.5 W/m

CATEGORY 1B 500mA (1B)	5560-SF-1B-57cm	57cm	11.6	1960	2070	2070	2020
	5560-SF-1B-85cm	85cm	17.4	2940	3105	3105	3030
	5560-SF-1B-113cm	113cm	23.2	3920	4140	4140	4040
	5560-SF-1B-141cm	141cm	29	4900	5175	5175	5050
	5560-SF-1B-169cm	169cm	34.8	5880	6210	6210	6060
	5560-SF-1B-197cm	197cm	40.6	6860	7245	7245	7070
	5560-SF-1B-225cm	225cm	46.4	7840	8280	8280	8080
	5560-SF-1B-253cm	253cm	52.2	8820	9315	9315	9090
	5560-SF-1B-281cm	281cm	58	9800	10350	10350	10100
	5560-SF-1B-309cm	309cm	63.8	10780	11385	11385	11110
	5560-SF-1B-337cm	337cm	69.6	11760	12420	12420	12120
	5560-SF-1B-365cm	365cm	75.4	12740	13455	13455	13130
	5560-SF-1B-393cm	393cm	81.2	13720	14490	14490	14140
	5560-SF-1B-421cm	421cm	87	14700	15525	15525	15150
	5560-SF-1B-449cm	449cm	92.8	15680	16560	16560	16160

Wattage: 20 W/m

Το φωτιστικό είναι διαθέσιμο σε μήκος πολλαπλάσιο των 14 εκατοστών

The illuminant is available in lengths that are multiples of 14 centimeters.

GANGES SURFACE 55×60 / Lumen output tables

CATEGORY 2A 350mA (2A)	SKU	Length	Wattage	Lumens 3000K	Lumens 4000K	Lumens 5000K	Lumens 6500K
	5560-SF-2A-57cm	57cm	23.6	4080	4380	4380	4080
	5560-SF-2A-85cm	85cm	35.4	6120	6570	6570	6120
	5560-SF-2A-113cm	113cm	47.2	8160	8760	8760	8160
	5560-SF-2A-141cm	141cm	59	10200	10950	10950	10200
	5560-SF-2A-169cm	169cm	70.8	12240	13140	13140	12240
	5560-SF-2A-197cm	197cm	82.6	14280	15330	15330	14280
	5560-SF-2A-225cm	225cm	94.4	16320	17520	17520	16320
	5560-SF-2A-253cm	253cm	106.2	18360	19710	19710	18360
	5560-SF-2A-281cm	281cm	118	20400	21900	21900	20400
	5560-SF-2A-309cm	309cm	129.8	22440	24090	24090	22440
	5560-SF-2A-337cm	337cm	141.6	24480	26280	26280	24480
	5560-SF-2A-365cm	365cm	153.4	26520	28470	28470	26520
	5560-SF-2A-393cm	393cm	165.2	28560	30660	30660	28560
	5560-SF-2A-421cm	421cm	177	30600	32850	32850	30600
5560-SF-2A-449cm	449cm	188.8	32640	35040	35040	32640	

Wattage: 40.5 W/m

CATEGORY 2B 500mA (2B)	SKU	Length	Wattage	Lumens 3000K	Lumens 4000K	Lumens 5000K	Lumens 6500K
	5560-SF-2B-57cm	57cm	35	5700	6140	6140	5700
	5560-SF-2B-85cm	85cm	52.5	8550	9210	9210	8550
	5560-SF-2B-113cm	113cm	70	11400	12280	12280	11400
	5560-SF-2B-141cm	141cm	87.5	14250	15350	15350	14250
	5560-SF-2B-169cm	169cm	105	17100	18420	18420	17100
	5560-SF-2B-197cm	197cm	122.5	19950	21490	21490	19950
	5560-SF-2B-225cm	225cm	140	22800	24560	24560	22800
	5560-SF-2B-253cm	253cm	157.5	25650	27630	27630	25650
	5560-SF-2B-281cm	281cm	175	28500	30700	30700	28500
	5560-SF-2B-309cm	309cm	192.5	31350	33770	33770	31350
	5560-SF-2B-337cm	337cm	210	34200	36840	36840	34200
	5560-SF-2B-365cm	365cm	227.5	37050	39910	39910	37050
	5560-SF-2B-393cm	393cm	245	39900	42980	42980	39900
	5560-SF-2B-421cm	421cm	262.5	42750	46050	46050	42750
5560-SF-2B-449cm	449cm	280	45600	49120	49120	45600	

Wattage: 60.5 W/m

Το φωτιστικό είναι διαθέσιμο σε μήκος πολλαπλάσιο των 14 εκατοστών

The illuminant is available in lengths that are multiples of 14 centimeters.



Linears

SURFACE MOUNTED

41

BARISLIGHT

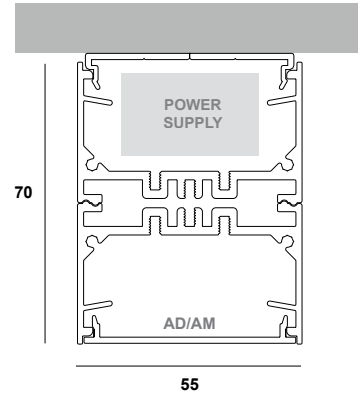

5570-SF - XX - XX - XX - XX - XX - X



(a)	(b)	(c)	(d)	(e)	(f)	(g)
Κωδικός Γραμμικού Linear Code	Κατηγορία Category	Μήκος Length	Θερμοκρασία φωτός Color Temperature	Χρώμα προφίλ Profile color	Κάλυμμα Cover	Αυξομείωση έντασης φωτός Dimming

Παράδειγμα κωδικού / Code example

LINEAR SURFACE 55×70, 1A, 87cm, 3000K, Black, with Acrylic Diffuser, Dimmable

SKU: 5570-SF-1A-87cm-30K-BL-AD-D

Material	PCB details	CRI	Lumen output / W
Extruded aluminium	Zhaga-Compliant Dimensions	Ra>80 (Ra>90 on request)	up to 195 Lm/W

Covers	Profile color	CCT	Dimming options (D)
Acrylic Diffuser (AD) 	Anodized (AN)	3000K (30K)	Push
	Black (BL)	4000K (40K)	DALI
	White (WH)	5000K (50K)	TRIAC 0/1-10V
Acrylic Microprismatic (AM) 	RAL (RL)	6500K (65K)	CASAMBI
	Graphite (GF)	TUNABLE 2700K - 6500K (TN)	Analog 0/1-10V
	Nickeling (NK)		
	Patina (PT)		

LINEAR SURFACE 55×70 / Lumen output tables

CATEGORY 1A 350mA (1A)	SKU	Length	Wattage	Lumens 3000K	Lumens 4000K	Lumens 5000K	Lumens 6500K
	5570-SF-1A-57cm	57cm	7.8	1390	1470	1470	1440
	5570-SF-1A-85cm	85cm	11.7	2085	2205	2205	2160
	5570-SF-1A-113cm	113cm	15.6	2780	2940	2940	2880
	5570-SF-1A-141cm	141cm	19.5	3475	3675	3675	3600
	5570-SF-1A-169cm	169cm	23.4	4170	4410	4410	4320
	5570-SF-1A-197cm	197cm	27.3	4865	5145	5145	5040
	5570-SF-1A-225cm	225cm	31.2	5560	5880	5880	5760
	5570-SF-1A-253cm	253cm	35.1	6255	6615	6615	6480
	5570-SF-1A-281cm	281cm	39	6950	7350	7350	7200
	5570-SF-1A-309cm	309cm	42.9	7645	8085	8085	7920
	5570-SF-1A-337cm	337cm	46.8	8340	8820	8820	8640
	5570-SF-1A-365cm	365cm	50.7	9035	9555	9555	9360
	5570-SF-1A-393cm	393cm	54.6	9730	10290	10290	10080
	5570-SF-1A-421cm	421cm	58.5	10425	11025	11025	10800
5570-SF-1A-449cm	449cm	62.4	11120	11760	11760	11520	

Wattage: 13.5 W/m

CATEGORY 1B 500mA (1B)	5570-SF-1B-57cm	57cm	11.6	1960	2070	2070	2020
	5570-SF-1B-85cm	85cm	17.4	2940	3105	3105	3030
	5570-SF-1B-113cm	113cm	23.2	3920	4140	4140	4040
	5570-SF-1B-141cm	141cm	29	4900	5175	5175	5050
	5570-SF-1B-169cm	169cm	34.8	5880	6210	6210	6060
	5570-SF-1B-197cm	197cm	40.6	6860	7245	7245	7070
	5570-SF-1B-225cm	225cm	46.4	7840	8280	8280	8080
	5570-SF-1B-253cm	253cm	52.2	8820	9315	9315	9090
	5570-SF-1B-281cm	281cm	58	9800	10350	10350	10100
	5570-SF-1B-309cm	309cm	63.8	10780	11385	11385	11110
	5570-SF-1B-337cm	337cm	69.6	11760	12420	12420	12120
	5570-SF-1B-365cm	365cm	75.4	12740	13455	13455	13130
	5570-SF-1B-393cm	393cm	81.2	13720	14490	14490	14140
	5570-SF-1B-421cm	421cm	87	14700	15525	15525	15150
	5570-SF-1B-449cm	449cm	92.8	15680	16560	16560	16160

Wattage: 20 W/m

Το φωτιστικό είναι διαθέσιμο σε μήκος πολλαπλάσιο των 14 εκατοστών
 The illuminant is available in lengths that are multiples of 14 centimeters.

LINEAR SURFACE 55×70 / Lumen output tables

CATEGORY 2A 350mA (2A)	SKU	Length	Wattage	Lumens 3000K	Lumens 4000K	Lumens 5000K	Lumens 6500K
	5570-SF-2A-57cm	57cm	23.6	4080	4380	4380	4080
	5570-SF-2A-85cm	85cm	35.4	6120	6570	6570	6120
	5570-SF-2A-113cm	113cm	47.2	8160	8760	8760	8160
	5570-SF-2A-141cm	141cm	59	10200	10950	10950	10200
	5570-SF-2A-169cm	169cm	70.8	12240	13140	13140	12240
	5570-SF-2A-197cm	197cm	82.6	14280	15330	15330	14280
	5570-SF-2A-225cm	225cm	94.4	16320	17520	17520	16320
	5570-SF-2A-253cm	253cm	106.2	18360	19710	19710	18360
	5570-SF-2A-281cm	281cm	118	20400	21900	21900	20400
	5570-SF-2A-309cm	309cm	129.8	22440	24090	24090	22440
	5570-SF-2A-337cm	337cm	141.6	24480	26280	26280	24480
	5570-SF-2A-365cm	365cm	153.4	26520	28470	28470	26520
	5570-SF-2A-393cm	393cm	165.2	28560	30660	30660	28560
	5570-SF-2A-421cm	421cm	177	30600	32850	32850	30600
5570-SF-2A-449cm	449cm	188.8	32640	35040	35040	32640	

Wattage: 40.5 W/m

CATEGORY 2B 500mA (2B)	SKU	Length	Wattage	Lumens 3000K	Lumens 4000K	Lumens 5000K	Lumens 6500K
	5570-SF-2B-57cm	57cm	35	5700	6140	6140	5700
	5570-SF-2B-85cm	85cm	52.5	8550	9210	9210	8550
	5570-SF-2B-113cm	113cm	70	11400	12280	12280	11400
	5570-SF-2B-141cm	141cm	87.5	14250	15350	15350	14250
	5570-SF-2B-169cm	169cm	105	17100	18420	18420	17100
	5570-SF-2B-197cm	197cm	122.5	19950	21490	21490	19950
	5570-SF-2B-225cm	225cm	140	22800	24560	24560	22800
	5570-SF-2B-253cm	253cm	157.5	25650	27630	27630	25650
	5570-SF-2B-281cm	281cm	175	28500	30700	30700	28500
	5570-SF-2B-309cm	309cm	192.5	31350	33770	33770	31350
	5570-SF-2B-337cm	337cm	210	34200	36840	36840	34200
	5570-SF-2B-365cm	365cm	227.5	37050	39910	39910	37050
	5570-SF-2B-393cm	393cm	245	39900	42980	42980	39900
	5570-SF-2B-421cm	421cm	262.5	42750	46050	46050	42750
5570-SF-2B-449cm	449cm	280	45600	49120	49120	45600	

Wattage: 60.5 W/m

Το φωτιστικό είναι διαθέσιμο σε μήκος πολλαπλάσιο των 14 εκατοστών

The illuminant is available in lengths that are multiples of 14 centimeters.

DARK LINEAR SURFACE 55×70 (D5570-SF)

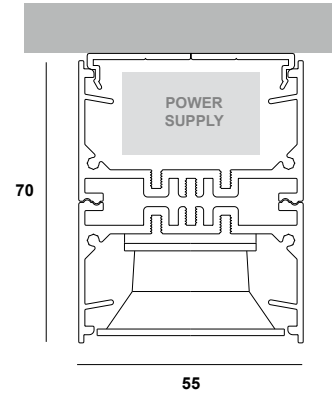

D5570-SF - XX - XX - XX - XX - XX - X - X



(a)	(b)	(c)	(d)	(e)	(f)	(g)	(h)
Κωδικός Γραμμικού Linear Code	Κατηγορία Category	Μήκος Length	Θερμοκρασία φωτός Color Temperature	Γωνία Δέσμης Beam Angle	Χρώμα προφίλ Profile Color	Χρώμα Ρεφλέκτορα Reflector Color	Αυξομείωση έντασης φωτός Dimming

Παράδειγμα κωδικού / Code example

DARK LINEAR SURFACE 55×70, 1A, 84.5cm, 3000K, 65D, Black, with Black Reflector, Dimmable

SKU: D5570-SF-1A-84.5cm-30K-65D-BL-1-D

Material	PCB details	CRI	Lumen output / W
Extruded aluminium / Plastic	SMD light & dark 7×1	Ra>90 (Ra>80 on request)	up to 205 Lm/W

CCT	Beam angle	Profile color	Reflector color	Dimming options (D)
3000K (30K)	Medium 65D (65D)	Anodized (AN)	 Black (1)	Push
4000K (40K)	Wide 90D (90D)	Black (BL)		DALI
5000K (50K)		White (WH)	 White (2)	TRIAC 0/1-10V
6500K (65K)	RAL (RL)	CASAMBI		
TUNABLE 2700K - 6500K (TN)	Graphite (GF)	Analog 0/1-10V		
	Nickeling (NK)			
	Patina (PT)			

DARK LINEAR SURFACE 55×70 / Lumen output tables

CATEGORY 1A 350mA (1A)	SKU	Length	Wattage	Lumens 3000K (65D)	Lumens 3000K (90D)	Lumens 4000K (65D)	Lumens 4000K (90D)
	D5570-SF-1A-56.5cm	56.5cm	13.4	1702	1680	1774	1752
	D5570-SF-1A-84.5cm	84.5cm	20.1	2553	2520	2661	2628
	D5570-SF-1A-112.5cm	112.5cm	26.8	3404	3360	3548	3504
	D5570-SF-1A-140.5cm	140.5cm	33.5	4255	4200	4435	4380
	D5570-SF-1A-168.5cm	168.5cm	40.2	5106	5040	5322	5256
	D5570-SF-1A-196.5cm	196.5cm	46.9	5957	5880	6209	6132
	D5570-SF-1A-224.5cm	224.5cm	53.6	6808	6720	7096	7008
	D5570-SF-1A-252.5cm	252.5cm	60.3	7659	7560	7983	7884
	D5570-SF-1A-280.5cm	280.5cm	67	8510	8400	8870	8760
	D5570-SF-1A-308.5cm	308.5cm	73.7	9361	9240	9757	9636
	D5570-SF-1A-336.5cm	336.5cm	80.4	10212	10080	10644	10512
	D5570-SF-1A-364.5cm	364.5cm	87.1	11063	10920	11531	11388
	D5570-SF-1A-392.5cm	392.5cm	93.8	11914	11760	12418	12264
	D5570-SF-1A-420.5cm	420.5cm	100.5	12765	12600	13305	13140
D5570-SF-1A-448.5cm	448.5cm	107.2	13616	13440	14192	14016	

Wattage: 23 W/m

CATEGORY 1B 500mA (1B)	SKU	Length	Wattage	Lumens 3000K (65D)	Lumens 3000K (90D)	Lumens 4000K (65D)	Lumens 4000K (90D)
	D5570-SF-1B-56.5cm	56.5cm	19.8	2398	2368	2512	2480
	D5570-SF-1B-84.5cm	84.5cm	29.7	3597	3552	3768	3720
	D5570-SF-1B-112.5cm	112.5cm	39.6	4796	4736	5024	4960
	D5570-SF-1B-140.5cm	140.5cm	49.5	5995	5920	6280	6200
	D5570-SF-1B-168.5cm	168.5cm	59.4	7194	7104	7536	7440
	D5570-SF-1B-196.5cm	196.5cm	69.3	8393	8288	8792	8680
	D5570-SF-1B-224.5cm	224.5cm	79.2	9592	9472	10048	9920
	D5570-SF-1B-252.5cm	252.5cm	89.1	10791	10656	11304	11160
	D5570-SF-1B-280.5cm	280.5cm	99	11990	11840	12560	12400
	D5570-SF-1B-308.5cm	308.5cm	108.9	13189	13024	13816	13640
	D5570-SF-1B-336.5cm	336.5cm	118.8	14388	14208	15072	14880
	D5570-SF-1B-364.5cm	364.5cm	128.7	15587	15392	16328	16120
	cmD5570-SF-1B-392.5	392.5cm	138.6	16786	16576	17584	17360
	D5570-SF-1B-420.5cm	420.5cm	148.5	17985	17760	18840	18600
D5570-SF-1B-448.5cm	448.5cm	158.4	19184	18944	20096	19840	

Wattage: 34 W/m

Το φωτιστικό είναι διαθέσιμο σε μήκος πολλαπλάσιο των 28 εκατοστών

The illuminant is available in lengths that are multiples of 28 centimeters.



Linears

SURFACE MOUNTED

BARISLIGHT

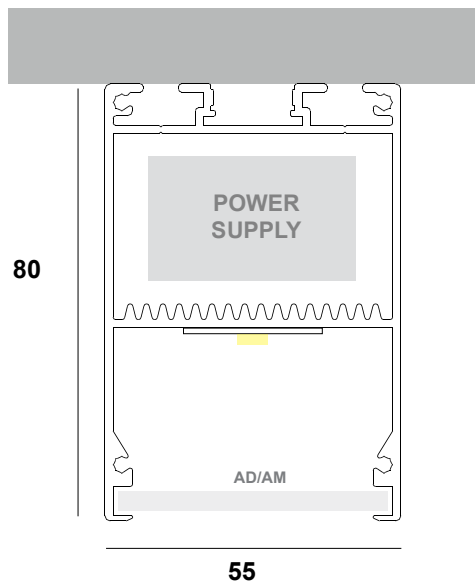



5580-SF - XX - XXX - X - XX - XX - X

- (a)
Κωδικός Γραμμικού
Linear Code
- (b)
Κατηγορία
Category
- (c)
Μήκος
Length
- (d)
Θερμοκρασία
φωτός
Color
Temperature
- (e)
Χρώμα
προφίλ
Profile
color
- (f)
Κάλυμμα
Cover
- (g)
Αυξομείωση
έντασης φωτός
Dimming

Παράδειγμα κωδικού / Code example

NILE SURFACE 55×80, 1A, 88cm, 3000K, Black, with Acrylic Diffuser, Dimmable
SKU: 5580-SF-1A-88cm-30K-BL-AD-D

Material	PCB details	CRI	Lumen output / W
Extruded aluminium	Zhaga-Compliant Dimensions	Ra>80 (Ra>90 on request)	up to 195 Lm/W

Covers	Profile color	CCT	Dimming options (D)
Acrylic Diffuser (AD) 	Anodized (AN)	3000K (30K)	Push
	Black (BL)	4000K (40K)	DALI
	White (WH)	5000K (50K)	TRIAC 0/1-10V
Acrylic Microprismatic (AM) 	RAL (RL)	6500K (65K)	CASAMBI
	Graphite (GF)	TUNABLE 2700K - 6500K (TN)	Analog 0/1-10V
	Nickeling (NK)		
	Patina (PT)		

NILE SURFACE 55×80 / Lumen output tables

CATEGORY 1A 350mA (1A)	SKU	Length	Wattage	Lumens 3000K	Lumens 4000K	Lumens 5000K	Lumens 6500K
	5580-SF-1A-60cm	60cm	7.8	1390	1470	1470	1440
	5580-SF-1A-88cm	88cm	11.7	2085	2205	2205	2160
	5580-SF-1A-116cm	116cm	15.6	2780	2940	2940	2880
	5580-SF-1A-144cm	144cm	19.5	3475	3675	3675	3600
	5580-SF-1A-172cm	172cm	23.4	4170	4410	4410	4320
	5580-SF-1A-200cm	200cm	27.3	4865	5145	5145	5040
	5580-SF-1A-228cm	228cm	31.2	5560	5880	5880	5760
	5580-SF-1A-256cm	256cm	35.1	6255	6615	6615	6480
	5580-SF-1A-284cm	284cm	39	6950	7350	7350	7200
	5580-SF-1A-312cm	312cm	42.9	7645	8085	8085	7920
	5580-SF-1A-340cm	340cm	46.8	8340	8820	8820	8640
	5580-SF-1A-368cm	368cm	50.7	9035	9555	9555	9360
	5580-SF-1A-396cm	396cm	54.6	9730	10290	10290	10080
	5580-SF-1A-424cm	424cm	58.5	10425	11025	11025	10800
5580-SF-1A-452cm	452cm	62.4	11120	11760	11760	11520	

Wattage: 13.5 W/m

CATEGORY 1B 500mA (1B)	5580-SF-1B-60cm	60cm	11.6	1960	2070	2070	2020
	5580-SF-1B-88cm	88cm	17.4	2940	3105	3105	3030
	5580-SF-1B-116cm	116cm	23.2	3920	4140	4140	4040
	5580-SF-1B-144cm	144cm	29	4900	5175	5175	5050
	5580-SF-1B-172cm	172cm	34.8	5880	6210	6210	6060
	5580-SF-1B-200cm	200cm	40.6	6860	7245	7245	7070
	5580-SF-1B-228cm	228cm	46.4	7840	8280	8280	8080
	5580-SF-1B-256cm	256cm	52.2	8820	9315	9315	9090
	5580-SF-1B-284cm	284cm	58	9800	10350	10350	10100
	5580-SF-1B-312cm	312cm	63.8	10780	11385	11385	11110
	5580-SF-1B-340cm	340cm	69.6	11760	12420	12420	12120
	5580-SF-1B-368cm	368cm	75.4	12740	13455	13455	13130
	5580-SF-1B-396cm	396cm	81.2	13720	14490	14490	14140
	5580-SF-1B-424cm	424cm	87	14700	15525	15525	15150
	5580-SF-1B-452cm	452cm	92.8	15680	16560	16560	16160

Wattage: 20 W/m

Το φωτιστικό είναι διαθέσιμο σε μήκος πολλαπλάσιο των 14 εκατοστών

The illuminant is available in lengths that are multiples of 14 centimeters.

NILE SURFACE 55×80 / Lumen output tables

CATEGORY 2A 350mA (2A)	SKU	Length	Wattage	Lumens 3000K	Lumens 4000K	Lumens 5000K	Lumens 6500K
	5580-SF-2A-60cm	60cm	23.6	4080	4380	4380	4080
	5580-SF-2A-88cm	88cm	35.4	6120	6570	6570	6120
	5580-SF-2A-116cm	116cm	47.2	8160	8760	8760	8160
	5580-SF-2A-144cm	144cm	59	10200	10950	10950	10200
	5580-SF-2A-172cm	172cm	70.8	12240	13140	13140	12240
	5580-SF-2A-200cm	200cm	82.6	14280	15330	15330	14280
	5580-SF-2A-228cm	228cm	94.4	16320	17520	17520	16320
	5580-SF-2A-256cm	256cm	106.2	18360	19710	19710	18360
	5580-SF-2A-284cm	284cm	118	20400	21900	21900	20400
	5580-SF-2A-312cm	312cm	129.8	22440	24090	24090	22440
	5580-SF-2A-340cm	340cm	141.6	24480	26280	26280	24480
	5580-SF-2A-368cm	368cm	153.4	26520	28470	28470	26520
	5580-SF-2A-396cm	396cm	165.2	28560	30660	30660	28560
	5580-SF-2A-424cm	424cm	177	30600	32850	32850	30600
5580-SF-2A-452cm	452cm	188.8	32640	35040	35040	32640	

Wattage: 40.5 W/m

CATEGORY 2B 500mA (2B)	5580-SF-2B-60cm	60cm	35	5700	6140	6140	5700
	5580-SF-2B-88cm	88cm	52.5	8550	9210	9210	8550
	5580-SF-2B-116cm	116cm	70	11400	12280	12280	11400
	5580-SF-2B-144cm	144cm	87.5	14250	15350	15350	14250
	5580-SF-2B-172cm	172cm	105	17100	18420	18420	17100
	5580-SF-2B-200cm	200cm	122.5	19950	21490	21490	19950
	5580-SF-2B-228cm	228cm	140	22800	24560	24560	22800
	5580-SF-2B-256cm	256cm	157.5	25650	27630	27630	25650
	5580-SF-2B-284cm	284cm	175	28500	30700	30700	28500
	5580-SF-2B-312cm	312cm	192.5	31350	33770	33770	31350
	5580-SF-2B-340cm	340cm	210	34200	36840	36840	34200
	5580-SF-2B-368cm	368cm	227.5	37050	39910	39910	37050
	5580-SF-2B-396cm	396cm	245	39900	42980	42980	39900
	5580-SF-2B-424cm	424cm	262.5	42750	46050	46050	42750
	5580-SF-2B-452cm	452cm	280	45600	49120	49120	45600

Wattage: 60.5 W/m

Το φωτιστικό είναι διαθέσιμο σε μήκος πολλαπλάσιο των 14 εκατοστών

The illuminant is available in lengths that are multiples of 14 centimeters.



Linears

SURFACE MOUNTED

51

BARISLIGHT

ΚΡΕΜΑΣΤΑ / SUSPENDED

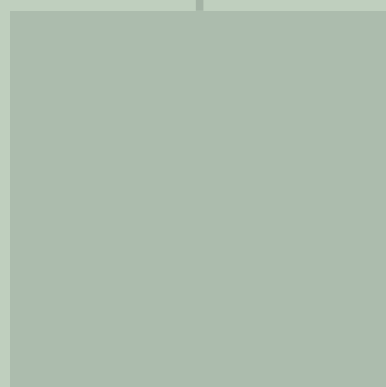

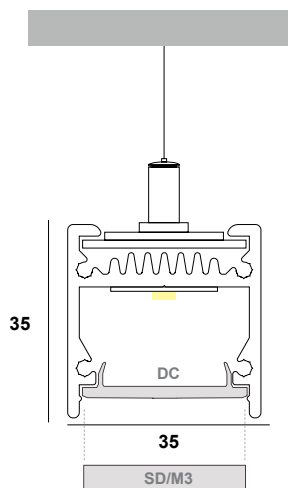
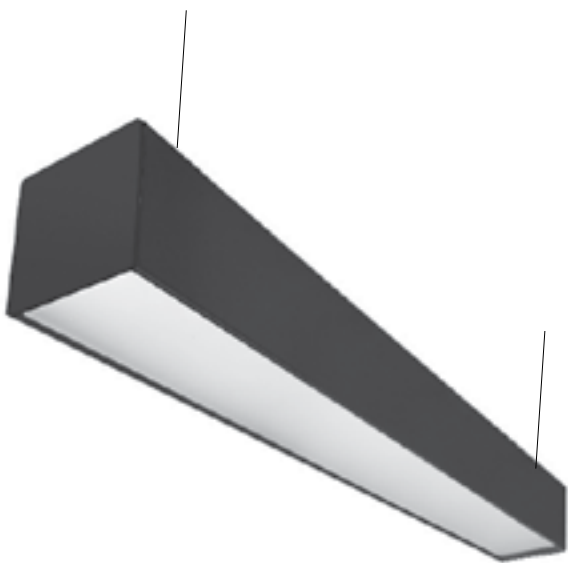

S35-SPD - XX - XX - XX - XX - XX - X - XX

(a)	(b)	(c)	(d)	(e)	(f)	(g)	(h)
Κωδικός Γραμμικού Linear Code	Κατηγορία Category	Μήκος Length	Θερμοκρασία φωτός Color Temperature	Χρώμα προφίλ Profile color	Κάλυμμα Cover	Αυξομείωση έντασης φωτός Dimming	Τοποθέτηση τροφοδοτικού Power supply installation

Παράδειγμα κωδικού / Code example

GILA SUSPENDED 35×35, 1A, 87cm, 3000K, Black, with Slide Diffuser 5mm, Dimmable, Hidden power supply
 SKU: S35-SPD-1A-87cm-30K-SD-D-HP

Material	PCB details	CRI	Lumen output / W
Extruded aluminium	Zhaga-Compliant Dimensions	Ra>80 (Ra>90 on request)	up to 195 Lm/W

Covers	Profile color	CCT	Dimming options (D)
Click Diffuser 1.5mm (up to 70m reel) (DC)	Anodized (AN)	3000K (30K)	Push
	Black (BL)	4000K (40K)	DALI
	White (WH)	5000K (50K)	TRIAC 0/1-10V
Click Diffuser 3mm (DC1)	RAL (RL)	6500K (65K)	CASAMBI
	Graphite (GF)	TUNABLE 2700K - 6500K (TN)	Analog 0/1-10V
Click Diffuser 5mm (SD)	Nickeling (NK)		
		Patina (PT)	
Microprismatic (M3)			

power supply installation

<p>Σε ροζέτα στην οροφή In rosette on the ceiling (RP)</p>	<p>Κρυφό με καταπακτή πρόσβασης Hidden with access hatch (HP)</p>
---	--



GILA SUSPENDED 35×35 / Lumen output tables

CATEGORY 1A 350mA (1A)	SKU	Length	Wattage	Lumens 3000K	Lumens 4000K	Lumens 5000K	Lumens 6500K
	S35-SPD-1A-59cm	59cm	7.8	1390	1470	1470	1440
	S35-SPD-1A-87cm	87cm	11.7	2085	2205	2205	2160
	S35-SPD-1A-115cm	115cm	15.6	2780	2940	2940	2880
	S35-SPD-1A-143cm	143cm	19.5	3475	3675	3675	3600
	S35-SPD-1A-171cm	171cm	23.4	4170	4410	4410	4320
	S35-SPD-1A-199cm	199cm	27.3	4865	5145	5145	5040
	S35-SPD-1A-227cm	227cm	31.2	5560	5880	5880	5760
	S35-SPD-1A-255cm	255cm	35.1	6255	6615	6615	6480
	S35-SPD-1A-283cm	283cm	39	6950	7350	7350	7200
	S35-SPD-1A-311cm	311cm	42.9	7645	8085	8085	7920
	S35-SPD-1A-339cm	339cm	46.8	8340	8820	8820	8640
	S35-SPD-1A-367cm	367cm	50.7	9035	9555	9555	9360
	S35-SPD-1A-395cm	395cm	54.6	9730	10290	10290	10080
	S35-SPD-1A-423cm	423cm	58.5	10425	11025	11025	10800
S35-SPD-1A-451cm	451cm	62.4	11120	11760	11760	11520	

Wattage: 13.5 W/m

CATEGORY 1B 500mA (1B)	S35-SPD-1B-59cm	59cm	11.6	1960	2070	2070	2020
	S35-SPD-1B-87cm	87cm	17.4	2940	3105	3105	3030
	S35-SPD-1B-115cm	115cm	23.2	3920	4140	4140	4040
	S35-SPD-1B-143cm	143cm	29	4900	5175	5175	5050
	S35-SPD-1B-171cm	171cm	34.8	5880	6210	6210	6060
	S35-SPD-1B-199cm	199cm	40.6	6860	7245	7245	7070
	S35-SPD-1B-227cm	227cm	46.4	7840	8280	8280	8080
	S35-SPD-1B-255cm	255cm	52.2	8820	9315	9315	9090
	S35-SPD-1B-283cm	283cm	58	9800	10350	10350	10100
	S35-SPD-1B-311cm	311cm	63.8	10780	11385	11385	11110
	S35-SPD-1B-339cm	339cm	69.6	11760	12420	12420	12120
	S35-SPD-1B-367cm	367cm	75.4	12740	13455	13455	13130
	S35-SPD-1B-395cm	395cm	81.2	13720	14490	14490	14140
	S35-SPD-1B-423cm	423cm	87	14700	15525	15525	15150
	S35-SPD-1B-451cm	451cm	92.8	15680	16560	16560	16160

Wattage: 20 W/m

Το φωτιστικό είναι διαθέσιμο σε μήκος πολλαπλάσιο των 14 εκατοστών

The illuminant is available in lengths that are multiples of 14 centimeters.

GILA SUSPENDED 35×35 / Lumen output tables

CATEGORY 2A 350mA (2A)	SKU	Length	Wattage	Lumens 3000K	Lumens 4000K	Lumens 5000K	Lumens 6500K
	S35-SPD-2A-59cm	59cm	23.6	4080	4380	4380	4080
	S35-SPD-2A-87cm	87cm	35.4	6120	6570	6570	6120
	S35-SPD-2A-115cm	115cm	47.2	8160	8760	8760	8160
	S35-SPD-2A-143cm	143cm	59	10200	10950	10950	10200
	S35-SPD-2A-171cm	171cm	70.8	12240	13140	13140	12240
	S35-SPD-2A-199cm	199cm	82.6	14280	15330	15330	14280
	S35-SPD-2A-227cm	227cm	94.4	16320	17520	17520	16320
	S35-SPD-2A-255cm	255cm	106.2	18360	19710	19710	18360
	S35-SPD-2A-283cm	283cm	118	20400	21900	21900	20400
	S35-SPD-2A-311cm	311cm	129.8	22440	24090	24090	22440
	S35-SPD-2A-339cm	339cm	141.6	24480	26280	26280	24480
	S35-SPD-2A-367cm	367cm	153.4	26520	28470	28470	26520
	S35-SPD-2A-395cm	395cm	165.2	28560	30660	30660	28560
	S35-SPD-2A-423cm	423cm	177	30600	32850	32850	30600
S35-SPD-2A-451cm	451cm	188.8	32640	35040	35040	32640	

Wattage: 40.5 W/m

CATEGORY 2B 500mA (2B)	S35-SPD-2B-59cm	59cm	35	5700	6140	6140	5700
	S35-SPD-2B-87cm	87cm	52.5	8550	9210	9210	8550
	S35-SPD-2B-115cm	115cm	70	11400	12280	12280	11400
	S35-SPD-2B-143cm	143cm	87.5	14250	15350	15350	14250
	S35-SPD-2B-171cm	171cm	105	17100	18420	18420	17100
	S35-SPD-2B-199cm	199cm	122.5	19950	21490	21490	19950
	S35-SPD-2B-227cm	227cm	140	22800	24560	24560	22800
	S35-SPD-2B-255cm	255cm	157.5	25650	27630	27630	25650
	S35-SPD-2B-283cm	283cm	175	28500	30700	30700	28500
	S35-SPD-2B-311cm	311cm	192.5	31350	33770	33770	31350
	S35-SPD-2B-339cm	339cm	210	34200	36840	36840	34200
	S35-SPD-2B-367cm	367cm	227.5	37050	39910	39910	37050
	S35-SPD-2B-395cm	395cm	245	39900	42980	42980	39900
	S35-SPD-2B-423cm	423cm	262.5	42750	46050	46050	42750
	S35-SPD-2B-451cm	451cm	280	45600	49120	49120	45600

Wattage: 60.5 W/m

Το φωτιστικό είναι διαθέσιμο σε μήκος πολλαπλάσιο των 14 εκατοστών
 The illuminant is available in lengths that are multiples of 14 centimeters.

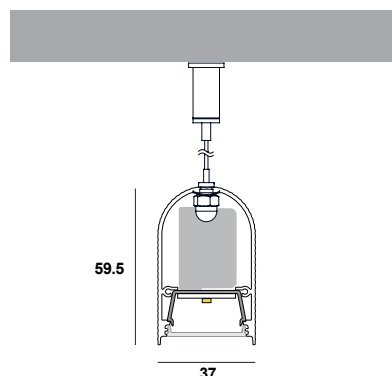

S3760F-SPD - XX - XX - XX - XX - XX - XX - XX

(a)
Κωδικός Γραμμικού
Linear Code

(b)
Κατηγορία
Category

(c)
Μήκος
Length

(d)
Θερμοκρασία
φωτός
Color
Temperature

(e)
Χρώμα
προφίλ
Profile color

(f)
Τάπες
End caps

(g)
Χρώμα
ταπών
End cap
color

(h)
Αυξομείωση
έντασης φωτός
Dimming

Παράδειγμα κωδικού / Code example

RHINE SUSPENDED 37×60 FLAT, 1A, 85cm, 3000K, Black Plastic End Caps, White End Caps, Dimmable

SKU: S3760F-SPD-1A-85cm-30K-BL-CP-WH-D

Material	PCB details	CRI	Lumen output / W
Extruded aluminium	Zhaga-Compliant Dimensions	Ra>80 (Ra>90 on request)	up to 195 Lm/W

Covers	End caps	Profile color / End caps color	CCT	Dimming options (D)
Click Diffuser Flat 	Plastic (CP)	Anodized (AN)	3000K (30K)	Push
	Metal (CM)	Black (BL)	4000K (40K)	DALI
		White (WH)	5000K (50K)	TRIAC 0/1-10V
	RAL (RL)	6500K (65K)	CASAMBI	
	Graphite (GF)	TUNABLE 2700K - 6500K (TN)	Analog 0/1-10V	
	Nickeling (NK)			
	Patina (PT)			

RHINE SUSPENDED 37×60 FLAT / Lumen output tables

CATEGORY 1A 350mA (1A)	SKU	Length	Wattage	Lumens 3000K	Lumens 4000K	Lumens 5000K	Lumens 6500K
	S3760F-SPD-1A-57cm	57cm	7.8	1390	1470	1470	1440
	S3760F-SPD-1A-85cm	85cm	11.7	2085	2205	2205	2160
	S3760F-SPD-1A-113cm	113cm	15.6	2780	2940	2940	2880
	S3760F-SPD-1A-141cm	141cm	19.5	3475	3675	3675	3600
	S3760F-SPD-1A-169cm	169cm	23.4	4170	4410	4410	4320
	S3760F-SPD-1A-196cm	197cm	27.3	4865	5145	5145	5040
	S3760F-SPD-1A-225cm	225cm	31.2	5560	5880	5880	5760
	S3760F-SPD-1A-253cm	253cm	35.1	6255	6615	6615	6480
	S3760F-SPD-1A-281cm	281cm	39	6950	7350	7350	7200

Wattage: 13.5 W/m

CATEGORY 1B 500mA (1B)	SKU	Length	Wattage	Lumens 3000K	Lumens 4000K	Lumens 5000K	Lumens 6500K
	S3760F-SPD-1B-57cm	57cm	11.6	1960	2070	2070	2020
	S3760F-SPD-1B-85cm	85cm	17.4	2940	3105	3105	3030
	S3760F-SPD-1B-113cm	113cm	23.2	3920	4140	4140	4040
	S3760F-SPD-1B-143cm	141cm	29	4900	5175	5175	5050
	S3760F-SPD-1B-169cm	169cm	34.8	5880	6210	6210	6060
	S3760F-SPD-1B-197cm	197cm	40.6	6860	7245	7245	7070
	S3760F-SPD-1B-225cm	225cm	46.4	7840	8280	8280	8080
	S3760F-SPD-1B-253cm	253cm	52.2	8820	9315	9315	9090
	S3760F-SPD-1B-281cm	281cm	58	9800	10350	10350	10100

Wattage: 20 W/m



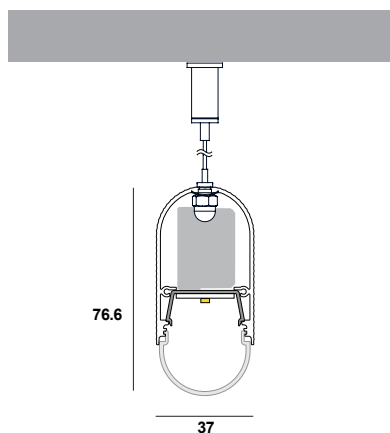

S3760V-SPD - XX - XX - XX - XX - XX - XX - XX

(a)
Κωδικός Γραμμικού
Linear Code

(b)
Κατηγορία
Category

(c)
Μήκος
Length

(d)
Θερμοκρασία
φωτός
Color
Temperature

(e)
Χρώμα
προφίλ
Profile color

(f)
Τάπες
End caps

(g)
Χρώμα
ταπών
End cap
color

(h)
Αυξομείωση
έντασης φωτός
Dimming

Παράδειγμα κωδικού / Code example

RHINE SUSPENDED 37×60 OVAL, 1A, 85cm, 3000K, Black, Plastic End Caps, White End Caps, Dimmable
SKU: S3760-SPDV-1A-85cm-30K-BL-DFF-CP-WH-D

Material	PCB details	CRI	Lumen output / W
Extruded aluminium	Zhaga-Compliant Dimensions	Ra>80 (Ra>90 on request)	up to 195 Lm/W

Covers	End caps	Profile color / End caps color	CCT	Dimming options (D)
Click Diffuser Oval 	Plastic (CP)	Anodized (AN)	3000K (30K)	Push
	Metal (CM)	Black (BL)	4000K (40K)	DALI
		White (WH)	5000K (50K)	TRIAC 0/1-10V
		RAL (RL)	6500K (65K)	CASAMBI
		Graphite (GF)	TUNABLE 2700K - 6500K (TN)	Analog 0/1-10V
		Nickeling (NK)		
		Patina (PT)		

RHINE SUSPENDED 37×60 OVAL / Lumen output tables

CATEGORY 1A 350mA (1A)	SKU	Length	Wattage	Lumens 3000K	Lumens 4000K	Lumens 5000K	Lumens 6500K
	S3760V-SPD-1A-57cm	57cm	7.8	1390	1470	1470	1440
	S3760V-SPD-1A-85cm	85cm	11.7	2085	2205	2205	2160
	S3760V-SPD-1A-113cm	113cm	15.6	2780	2940	2940	2880
	S3760V-SPD-1A-141cm	141cm	19.5	3475	3675	3675	3600
	S3760V-SPD-1A-169cm	169cm	23.4	4170	4410	4410	4320
	S3760V-SPD-1A-196cm	197cm	27.3	4865	5145	5145	5040
	S3760V-SPD-1A-225cm	225cm	31.2	5560	5880	5880	5760
	S3760V-SPD-1A-253cm	253cm	35.1	6255	6615	6615	6480
	S3760V-SPD-1A-281cm	281cm	39	6950	7350	7350	7200

Wattage: 13.5 W/m

CATEGORY 1B 500mA (1B)	SKU	Length	Wattage	Lumens 3000K	Lumens 4000K	Lumens 5000K	Lumens 6500K
	S3760V-SPD-1B-57cm	57cm	11.6	1960	2070	2070	2020
	S3760V-SPD-1B-85cm	85cm	17.4	2940	3105	3105	3030
	S3760V-SPD-1B-113cm	113cm	23.2	3920	4140	4140	4040
	S3760V-SPD-1B-143cm	141cm	29	4900	5175	5175	5050
	S3760V-SPD-1B-169cm	169cm	34.8	5880	6210	6210	6060
	S3760V-SPD-1B-197cm	197cm	40.6	6860	7245	7245	7070
	S3760V-SPD-1B-225cm	225cm	46.4	7840	8280	8280	8080
	S3760V-SPD-1B-253cm	253cm	52.2	8820	9315	9315	9090
	S3760V-SPD-1B-281cm	281cm	58	9800	10350	10350	10100

Wattage: 20 W/m



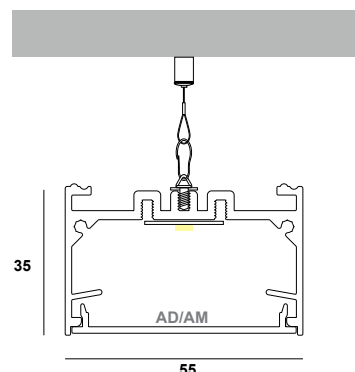

S5535-SPD - XX - XX - XX - XX - XX - X



- (a)
Κωδικός Γραμμικού
Linear Code
- (b)
Κατηγορία
Category
- (c)
Μήκος
Length
- (d)
Θερμοκρασία
φωτός
Color
Temperature
- (e)
Χρώμα
προφίλ
Profile
color
- (f)
Κάλυμμα
Cover
- (g)
Αυξομείωση
έντασης
φωτός
Dimming

Παράδειγμα κωδικού / Code example

LENA SUSPENDED 55×35, 1A, 85cm, 3000K, Black, with Acrylic Diffuser, Dimmable, Hidden power supply

SKU: S5535-SPD-1A-85cm-30K-BL-AD-D-HP

Material	PCB details	CRI	Lumen output / W
Extruded aluminium	Zhaga-Compliant Dimensions	Ra>80 (Ra>90 on request)	up to 195 Lm/W

Covers	Profile color	CCT	Dimming options (D)
Acrylic Diffuser (AD) 	Anodized (AN)	3000K (30K)	Push
	Black (BL)	4000K (40K)	DALI
	White (WH)	5000K (50K)	TRIAC 0/1-10V
Acrylic Microprismatic (AM) 	RAL (RL)	6500K (65K)	CASAMBI
	Graphite (GF)	TUNABLE 2700K - 6500K (TN)	Analog 0/1-10V
	Nickeling (NK)		
	Patina (PT)		

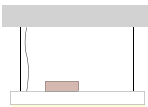
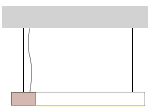
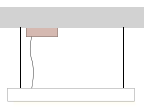
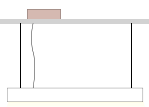
power supply installation			
 <p>Πάνω στο προφίλ με ροζέτα On the profile with rosette</p> <p>(RP)</p>	 <p>Δίπλα στο προφίλ με ροζέτα To the side of the profile with rosette</p> <p>(RP1)</p>	 <p>Σε ροζέτα στην οροφή In rosette on the ceiling</p> <p>(RP2)</p>	 <p>Κρυφό με καταπακτή πρόσβασης Hidden with access hatch</p> <p>(HP)</p>



Linears

SUSPENDED

63

BARISLIGHT

LENA SUSPENDED 55×35 / Lumen output tables

CATEGORY 1A 350mA (1A)	SKU	Length	Wattage	Lumens 3000K	Lumens 4000K	Lumens 5000K	Lumens 6500K
	S5535-SPD-1A-57cm	57cm	7.8	1390	1470	1470	1440
	S5535-SPD-1A-85cm	85cm	11.7	2085	2205	2205	2160
	S5535-SPD-1A-113cm	113cm	15.6	2780	2940	2940	2880
	S5535-SPD-1A-141cm	141cm	19.5	3475	3675	3675	3600
	S5535-SPD-1A-169cm	169cm	23.4	4170	4410	4410	4320
	S5535-SPD-1A-197cm	197cm	27.3	4865	5145	5145	5040
	S5535-SPD-1A-225cm	225cm	31.2	5560	5880	5880	5760
	S5535-SPD-1A-253cm	253cm	35.1	6255	6615	6615	6480
	S5535-SPD-1A-281cm	281cm	39	6950	7350	7350	7200
	S5535-SPD-1A-309cm	309cm	42.9	7645	8085	8085	7920
	S5535-SPD-1A-337cm	337cm	46.8	8340	8820	8820	8640
	S5535-SPD-1A-365cm	365cm	50.7	9035	9555	9555	9360
	S5535-SPD-1A-393cm	393cm	54.6	9730	10290	10290	10080
	S5535-SPD-1A-421cm	421cm	58.5	10425	11025	11025	10800
S5535-SPD-1A-449cm	449cm	62.4	11120	11760	11760	11520	

Wattage: 13.5 W/m

CATEGORY 1B 500mA (1B)	SKU	Length	Wattage	Lumens 3000K	Lumens 4000K	Lumens 5000K	Lumens 6500K
	S5535-SPD-1B-57cm	57cm	11.6	1960	2070	2070	2020
	S5535-SPD-1B-85cm	85cm	17.4	2940	3105	3105	3030
	S5535-SPD-1B-113cm	113cm	23.2	3920	4140	4140	4040
	S5535-SPD-1B-141cm	141cm	29	4900	5175	5175	5050
	S5535-SPD-1B-169cm	169cm	34.8	5880	6210	6210	6060
	S5535-SPD-1B-197cm	197cm	40.6	6860	7245	7245	7070
	S5535-SPD-1B-225cm	225cm	46.4	7840	8280	8280	8080
	S5535-SPD-1B-253cm	253cm	52.2	8820	9315	9315	9090
	S5535-SPD-1B-281cm	281cm	58	9800	10350	10350	10100
	S5535-SPD-1B-309cm	309cm	63.8	10780	11385	11385	11110
	S5535-SPD-1B-337cm	337cm	69.6	11760	12420	12420	12120
	S5535-SPD-1B-365cm	365cm	75.4	12740	13455	13455	13130
	S5535-SPD-1B-393cm	393cm	81.2	13720	14490	14490	14140
	S5535-SPD-1B-421cm	421cm	87	14700	15525	15525	15150
S5535-SPD-1B-449cm	449cm	92.8	15680	16560	16560	16160	

Wattage: 20 W/m

Το φωτιστικό είναι διαθέσιμο σε μήκος πολλαπλάσιο των 14 εκατοστών

The illuminant is available in lengths that are multiples of 14 centimeters.

LENA SUSPENDED 55×35 / Lumen output tables

CATEGORY 2A 350mA (2A)	SKU	Length	Wattage	Lumens 3000K	Lumens 4000K	Lumens 5000K	Lumens 6500K
	S5535-SPD-2A-57cm	57cm	23.6	4080	4380	4380	4080
	S5535-SPD-2A-85cm	85cm	35.4	6120	6570	6570	6120
	S5535-SPD-2A-113cm	113cm	47.2	8160	8760	8760	8160
	S5535-SPD-2A-141cm	141cm	59	10200	10950	10950	10200
	S5535-SPD-2A-169cm	169cm	70.8	12240	13140	13140	12240
	S5535-SPD-2A-197cm	197cm	82.6	14280	15330	15330	14280
	S5535-SPD-2A-225cm	225cm	94.4	16320	17520	17520	16320
	S5535-SPD-2A-253cm	253cm	106.2	18360	19710	19710	18360
	S5535-SPD-2A-281cm	281cm	118	20400	21900	21900	20400
	S5535-SPD-2A-309cm	309cm	129.8	22440	24090	24090	22440
	S5535-SPD-2A-337cm	337cm	141.6	24480	26280	26280	24480
	S5535-SPD-2A-365cm	365cm	153.4	26520	28470	28470	26520
	S5535-SPD-2A-393cm	393cm	165.2	28560	30660	30660	28560
	S5535-SPD-2A-421cm	421cm	177	30600	32850	32850	30600
S5535-SPD-2A-449cm	449cm	188.8	32640	35040	35040	32640	

Wattage: 40.5 W/m

CATEGORY 2B 500mA (2B)	S5535-SPD-2B-57cm	57cm	35	5700	6140	6140	5700
	S5535-SPD-2B-85cm	85cm	52.5	8550	9210	9210	8550
	S5535-SPD-2B-113cm	113cm	70	11400	12280	12280	11400
	S5535-SPD-2B-141cm	141cm	87.5	14250	15350	15350	14250
	S5535-SPD-2B-169cm	169cm	105	17100	18420	18420	17100
	S5535-SPD-2B-197cm	197cm	122.5	19950	21490	21490	19950
	S5535-SPD-2B-225cm	225cm	140	22800	24560	24560	22800
	S5535-SPD-2B-253cm	253cm	157.5	25650	27630	27630	25650
	S5535-SPD-2B-281cm	281cm	175	28500	30700	30700	28500
	S5535-SPD-2B-309cm	309cm	192.5	31350	33770	33770	31350
	S5535-SPD-2B-337cm	337cm	210	34200	36840	36840	34200
	S5535-SPD-2B-365cm	365cm	227.5	37050	39910	39910	37050
	S5535-SPD-2B-393cm	393cm	245	39900	42980	42980	39900
	S5535-SPD-2B-421cm	421cm	262.5	42750	46050	46050	42750
	S5535-SPD-2B-449cm	449cm	280	45600	49120	49120	45600

Wattage: 60.5 W/m

Το φωτιστικό είναι διαθέσιμο σε μήκος πολλαπλάσιο των 14 εκατοστών

The illuminant is available in lengths that are multiples of 14 centimeters.

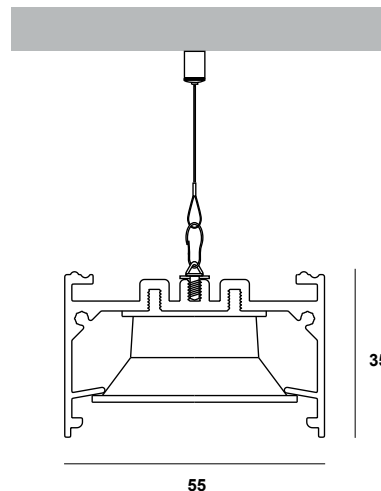



SD5535-SPD - XX - XX - XX - XX - XX - X - X - XX

(a)	(b)	(c)	(d)	(e)	(f)	(g)	(h)	(i)
Κωδικός Γραμμικού Linear Code	Κατηγορία Category	Μήκος Length	Θερμοκρασία φωτός Color Temperature	Γωνία Δέσμης Beam Angle	Χρώμα προφίλ Profile Color	Χρώμα Ρεφλέκτορα Reflector Color	Αυξομείωση έντασης φωτός Dimming	Τοποθέτηση τροφοδοτικού Power supply installation

Παράδειγμα κωδικού / Code example

DARK LENA SUSPENDED 55×35, 1A, 84.5cm, 3000K, 65D, Black, with Black Reflector, Dimmable, Hidden power supply
SKU: SD5535-SPD-1A-84.5cm-30K-65D-BL-1-D-HP

Material	PCB details	CRI	Lumen output / W
Extruded aluminium / Plastic	SMD light & dark 7×1	Ra>90 (Ra>80 on request)	up to 205 Lm/W

CCT	Beam angle	Profile color	Reflector color	Dimming options (D)
3000K (30K)	Medium 65D (65D)	Anodized (AN)	 Black (1)	Push
4000K (40K)	Wide 90D (90D)	Black (BL)		DALI
5000K (50K)		White (WH)	 White (2)	TRIAC 0/1-10V
6500K (65K)	RAL (RL)	CASAMBI		
TUNABLE 2700K - 6500K (TN)	Graphite (GF)	Analog 0/1-10V		
	Nickeling (NK)			
	Patina (PT)			

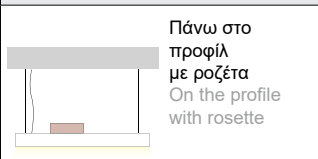
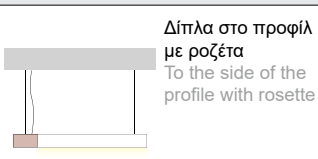
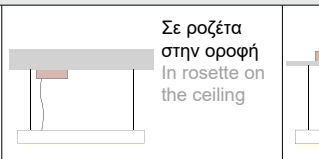
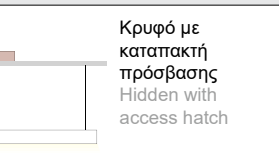
power supply installation			
 <p>Πάνω στο προφίλ με ροζέτα On the profile with rosette</p> <p>(RP)</p>	 <p>Δίπλα στο προφίλ με ροζέτα To the side of the profile with rosette</p> <p>(RP1)</p>	 <p>Σε ροζέτα στην οροφή In rosette on the ceiling</p> <p>(RP2)</p>	 <p>Κρυφό με καταπακτή πρόσβασης Hidden with access hatch</p> <p>(HP)</p>

DARK LENA SUSPENDED 55×35 / Lumen output tables

CATEGORY 1A 350mA (1A)	SKU	Length	Wattage	Lumens 3000K (65D)	Lumens 3000K (90D)	Lumens 4000K (65D)	Lumens 4000K (90D)
	SD5535-SPD-1A-56.5cm	56.5cm	13.4	1702	1680	1774	1752
	SD5535-SPD-1A-84.5cm	84.5cm	20.1	2553	2520	2661	2628
	SD5535-SPD-1A-112.5cm	112.5cm	26.8	3404	3360	3548	3504
	SD5535-SPD-1A-140.5cm	140.5cm	33.5	4255	4200	4435	4380
	SD5535-SPD-1A-168.5cm	168.5cm	40.2	5106	5040	5322	5256
	SD5535-SPD-1A-196.5cm	196.5cm	46.9	5957	5880	6209	6132
	SD5535-SPD-1A-224.5cm	224.5cm	53.6	6808	6720	7096	7008
	SD5535-SPD-1A-252.5cm	252.5cm	60.3	7659	7560	7983	7884
	SD5535-SPD-1A-280.5cm	280.5cm	67	8510	8400	8870	8760
	SD5535-SPD-1A-308.5cm	308.5cm	73.7	9361	9240	9757	9636
	SD5535-SPD-1A-336.5cm	336.5cm	80.4	10212	10080	10644	10512
	SD5535-SPD-1A-364.5cm	364.5cm	87.1	11063	10920	11531	11388
	SD5535-SPD-1A-392.5cm	392.5cm	93.8	11914	11760	12418	12264
	SD5535-SPD-1A-420.5cm	420.5cm	100.5	12765	12600	13305	13140
SD5535-SPD-1A-448.5cm	448.5cm	107.2	13616	13440	14192	14016	

Wattage: 23 W/m

CATEGORY 1B 500mA (1B)	SD5535-SPD-1B-56.5cm	56.5cm	19.8	2398	2368	2512	2480
	SD5535-SPD-1B-84.5cm	84.5cm	29.7	3597	3552	3768	3720
	SD5535-SPD-1B-112.5cm	112.5cm	39.6	4796	4736	5024	4960
	SD5535-SPD-1B-140.5cm	140.5cm	49.5	5995	5920	6280	6200
	SD5535-SPD-1B-168.5cm	168.5cm	59.4	7194	7104	7536	7440
	SD5535-SPD-1B-196.5cm	196.5cm	69.3	8393	8288	8792	8680
	SD5535-SPD-1B-224.5cm	224.5cm	79.2	9592	9472	10048	9920
	SD5535-SPD-1B-252.5cm	252.5cm	89.1	10791	10656	11304	11160
	SD5535-SPD-1B-280.5cm	280.5cm	99	11990	11840	12560	12400
	SD5535-SPD-1B-308.5cm	308.5cm	108.9	13189	13024	13816	13640
	SD5535-SPD-1B-336.5cm	336.5cm	118.8	14388	14208	15072	14880
	SD5535-SPD-1B-364.5cm	364.5cm	128.7	15587	15392	16328	16120
	SD5535-SPD-1B-392.5cm	392.5cm	138.6	16786	16576	17584	17360
	SD5535-SPD-1B-420.5cm	420.5cm	148.5	17985	17760	18840	18600
	SD5535-SPD-1B-448.5cm	448.5cm	158.4	19184	18944	20096	19840

Wattage: 34 W/m

Το φωτιστικό είναι διαθέσιμο σε μήκος πολλαπλάσιο των 28 εκατοστών
 The illuminant is available in lengths that are multiples of 28 centimeters.

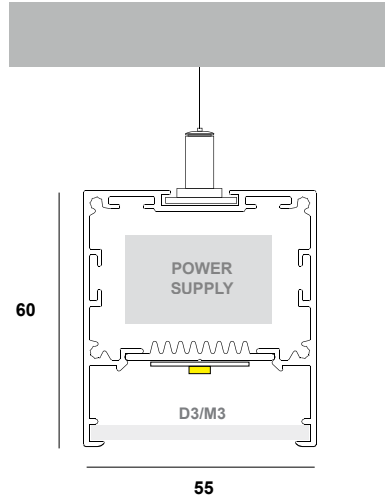



S5560-SPD - XX - XX - XX - XX - XX - X

- | | | | | | | |
|----------------------------------|-----------------------|-----------------|--|----------------|------------------|--|
| (a) | (b) | (c) | (d) | (e) | (f) | (g) |
| Κωδικός Γραμμικού
Linear Code | Κατηγορία
Category | Μήκος
Length | Θερμοκρασία
φωτός
Color
Temperature | Χρώμα
Color | Κάλυμμα
Cover | Αυξομείωση
έντασης φωτός
Dimming |

Παράδειγμα κωδικού / Code example

GANGES SUSPENDED 55×60, 1A, 85cm, 3000K, Black, with Diffuser, Dimmable
SKU: S5560-SPD-1A-85cm-30K-BL-D3-D

Material	PCB details	CRI	Lumen output / W
Extruded aluminium	Zhaga-Compliant Dimensions	Ra>80 (Ra>90 on request)	up to 195 Lm/W

Covers	Profile color	CCT	Dimming options (D)
Diffuser 3mm (D3) 	Anodized (AN)	3000K (30K)	Push
	Black (BL)	4000K (40K)	DALI
	White (WH)	5000K (50K)	TRIAC 0/1-10V
Microprismatic 3mm (M3) 	RAL (RL)	6500K (65K)	CASAMBI
	Graphite (GF)	TUNABLE 2700K - 6500K (TN)	Analog 0/1-10V
	Nickeling (NK)		
	Patina (PT)		

GANGES SUSPENDED 55×60 / Lumen output tables

CATEGORY 1A 350mA (1A)	SKU	Length	Wattage	Lumens 3000K	Lumens 4000K	Lumens 5000K	Lumens 6500K
	S5560-SPD-1A-57cm	57cm	7.8	1390	1470	1470	1440
	S5560-SPD-1A-85cm	85cm	11.7	2085	2205	2205	2160
	S5560-SPD-1A-113cm	113cm	15.6	2780	2940	2940	2880
	S5560-SPD-1A-141cm	141cm	19.5	3475	3675	3675	3600
	S5560-SPD-1A-169cm	169cm	23.4	4170	4410	4410	4320
	S5560-SPD-1A-197cm	197cm	27.3	4865	5145	5145	5040
	S5560-SPD-1A-225cm	225cm	31.2	5560	5880	5880	5760
	S5560-SPD-1A-253cm	253cm	35.1	6255	6615	6615	6480
	S5560-SPD-1A-281cm	281cm	39	6950	7350	7350	7200
	S5560-SPD-1A-309cm	309cm	42.9	7645	8085	8085	7920
	S5560-SPD-1A-337cm	337cm	46.8	8340	8820	8820	8640
	S5560-SPD-1A-365cm	365cm	50.7	9035	9555	9555	9360
	S5560-SPD-1A-393cm	393cm	54.6	9730	10290	10290	10080
	S5560-SPD-1A-421cm	421cm	58.5	10425	11025	11025	10800
S5560-SPD-1A-449cm	449cm	62.4	11120	11760	11760	11520	

Wattage: 13.5 W/m

CATEGORY 1B 500mA (1B)	S5560-SPD-1B-57cm	57cm	11.6	1960	2070	2070	2020
	S5560-SPD-1B-85cm	85cm	17.4	2940	3105	3105	3030
	S5560-SPD-1B-113cm	113cm	23.2	3920	4140	4140	4040
	S5560-SPD-1B-141cm	141cm	29	4900	5175	5175	5050
	S5560-SPD-1B-169cm	169cm	34.8	5880	6210	6210	6060
	S5560-SPD-1B-197cm	197cm	40.6	6860	7245	7245	7070
	S5560-SPD-1B-225cm	225cm	46.4	7840	8280	8280	8080
	S5560-SPD-1B-253cm	253cm	52.2	8820	9315	9315	9090
	S5560-SPD-1B-281cm	281cm	58	9800	10350	10350	10100
	S5560-SPD-1B-309cm	309cm	63.8	10780	11385	11385	11110
	S5560-SPD-1B-337cm	337cm	69.6	11760	12420	12420	12120
	S5560-SPD-1B-365cm	365cm	75.4	12740	13455	13455	13130
	S5560-SPD-1B-393cm	393cm	81.2	13720	14490	14490	14140
	S5560-SPD-1B-421cm	421cm	87	14700	15525	15525	15150
	S5560-SPD-1B-449cm	449cm	92.8	15680	16560	16560	16160

Wattage: 20 W/m

Το φωτιστικό είναι διαθέσιμο σε μήκος πολλαπλάσιο των 14 εκατοστών

The illuminant is available in lengths that are multiples of 14 centimeters.

GANGES SUSPENDED 55×60 / Lumen output tables

CATEGORY 2A 350mA (2A)	SKU	Length	Wattage	Lumens 3000K	Lumens 4000K	Lumens 5000K	Lumens 6500K
	S5560-SPD-2A-57cm	57cm	23.6	4080	4380	4380	4080
	S5560-SPD-2A-85cm	85cm	35.4	6120	6570	6570	6120
	S5560-SPD-2A-113cm	113cm	47.2	8160	8760	8760	8160
	S5560-SPD-2A-141cm	141cm	59	10200	10950	10950	10200
	S5560-SPD-2A-169cm	169cm	70.8	12240	13140	13140	12240
	S5560-SPD-2A-197cm	197cm	82.6	14280	15330	15330	14280
	S5560-SPD-2A-225cm	225cm	94.4	16320	17520	17520	16320
	S5560-SPD-2A-253cm	253cm	106.2	18360	19710	19710	18360
	S5560-SPD-2A-281cm	281cm	118	20400	21900	21900	20400
	S5560-SPD-2A-309cm	309cm	129.8	22440	24090	24090	22440
	S5560-SPD-2A-337cm	337cm	141.6	24480	26280	26280	24480
	S5560-SPD-2A-365cm	365cm	153.4	26520	28470	28470	26520
	S5560-SPD-2A-393cm	393cm	165.2	28560	30660	30660	28560
	S5560-SPD-2A-421cm	421cm	177	30600	32850	32850	30600
S5560-SPD-2A-449cm	449cm	188.8	32640	35040	35040	32640	

Wattage: 40.5 W/m

CATEGORY 2B 500mA (2B)	SKU	Length	Wattage	Lumens 3000K	Lumens 4000K	Lumens 5000K	Lumens 6500K
	S5560-SPD-2B-57cm	57cm	35	5700	6140	6140	5700
	S5560-SPD-2B-85cm	85cm	52.5	8550	9210	9210	8550
	S5560-SPD-2B-113cm	113cm	70	11400	12280	12280	11400
	S5560-SPD-2B-141cm	141cm	87.5	14250	15350	15350	14250
	S5560-SPD-2B-169cm	169cm	105	17100	18420	18420	17100
	S5560-SPD-2B-197cm	197cm	122.5	19950	21490	21490	19950
	S5560-SPD-2B-225cm	225cm	140	22800	24560	24560	22800
	S5560-SPD-2B-253cm	253cm	157.5	25650	27630	27630	25650
	S5560-SPD-2B-281cm	281cm	175	28500	30700	30700	28500
	S5560-SPD-2B-309cm	309cm	192.5	31350	33770	33770	31350
	S5560-SPD-2B-337cm	337cm	210	34200	36840	36840	34200
	S5560-SPD-2B-365cm	365cm	227.5	37050	39910	39910	37050
	S5560-SPD-2B-393cm	393cm	245	39900	42980	42980	39900
	S5560-SPD-2B-421cm	421cm	262.5	42750	46050	46050	42750
S5560-SPD-2B-449cm	449cm	280	45600	49120	49120	45600	

Wattage: 60.5 W/m

Το φωτιστικό είναι διαθέσιμο σε μήκος πολλαπλάσιο των 14 εκατοστών

The illuminant is available in lengths that are multiples of 14 centimeters.



Linears

SUSPENDED

71

BARISLIGHT

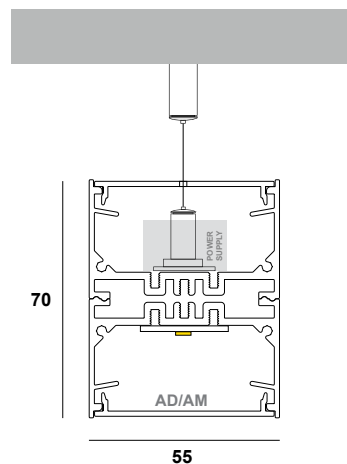

S5570-SPD - XX - XX - XX - XX - XX - X



- (a)
Κωδικός Γραμμικού
Linear Code
- (b)
Κατηγορία
Category
- (c)
Μήκος
Length
- (d)
Θερμοκρασία
φωτός
Color
Temperature
- (e)
Χρώμα
προφίλ
Profile
color
- (f)
Κάλυμμα
Cover
- (g)
Αυτομείωση
έντασης φωτός
Dimming

Παράδειγμα κωδικού / Code example

LINEAR SUSPENDED 55×70, 1A, 85cm, 3000K, Black, with Acrylic Diffuser, Dimmable

SKU: S5570-SPD-1A-85cm-30K-BL-AD-D

Material	PCB details	CRI	Lumen output / W
Extruded aluminium	Zhaga-Compliant Dimensions	Ra>80 (Ra>90 on request)	up to 195 Lm/W

Covers	Profile color	CCT	Dimming options (D)
Acrylic Diffuser (AD) 	Anodized (AN)	3000K (30K)	Push
	Black (BL)	4000K (40K)	DALI
	White (WH)	5000K (50K)	TRIAC 0/1-10V
Acrylic Microprismatic (AM) 	RAL (RL)	6500K (65K)	CASAMBI
	Graphite (GF)	TUNABLE 2700K - 6500K (TN)	Analog 0/1-10V
	Nickeling (NK)		
	Patina (PT)		

LINEAR SUSPENDED 55×70 / Lumen output tables

CATEGORY 1A 350mA (1A)	SKU	Length	Wattage	Lumens 3000K	Lumens 4000K	Lumens 5000K	Lumens 6500K
	S5570-SPD-1A-57cm	57cm	7.8	1390	1470	1470	1440
	S5570-SPD-1A-85cm	85cm	11.7	2085	2205	2205	2160
	S5570-SPD-1A-113cm	113cm	15.6	2780	2940	2940	2880
	S5570-SPD-1A-141cm	141cm	19.5	3475	3675	3675	3600
	S5570-SPD-1A-169cm	169cm	23.4	4170	4410	4410	4320
	S5570-SPD-1A-197cm	197cm	27.3	4865	5145	5145	5040
	S5570-SPD-1A-225cm	225cm	31.2	5560	5880	5880	5760
	S5570-SPD-1A-253cm	253cm	35.1	6255	6615	6615	6480
	S5570-SPD-1A-281cm	281cm	39	6950	7350	7350	7200
	S5570-SPD-1A-309cm	309cm	42.9	7645	8085	8085	7920
	S5570-SPD-1A-337cm	337cm	46.8	8340	8820	8820	8640
	S5570-SPD-1A-365cm	365cm	50.7	9035	9555	9555	9360
	S5570-SPD-1A-393cm	393cm	54.6	9730	10290	10290	10080
	S5570-SPD-1A-421cm	421cm	58.5	10425	11025	11025	10800
S5570-SPD-1A-449cm	449cm	62.4	11120	11760	11760	11520	

Wattage: 13.5 W/m

CATEGORY 1B 500mA (1B)	SKU	Length	Wattage	Lumens 3000K	Lumens 4000K	Lumens 5000K	Lumens 6500K
	S5570-SPD-1B-57cm	57cm	11.6	1960	2070	2070	2020
	S5570-SPD-1B-85cm	85cm	17.4	2940	3105	3105	3030
	S5570-SPD-1B-113cm	113cm	23.2	3920	4140	4140	4040
	S5570-SPD-1B-141cm	141cm	29	4900	5175	5175	5050
	S5570-SPD-1B-169cm	169cm	34.8	5880	6210	6210	6060
	S5570-SPD-1B-197cm	197cm	40.6	6860	7245	7245	7070
	S5570-SPD-1B-225cm	225cm	46.4	7840	8280	8280	8080
	S5570-SPD-1B-253cm	253cm	52.2	8820	9315	9315	9090
	S5570-SPD-1B-281cm	281cm	58	9800	10350	10350	10100
	S5570-SPD-1B-309cm	309cm	63.8	10780	11385	11385	11110
	S5570-SPD-1B-337cm	337cm	69.6	11760	12420	12420	12120
	S5570-SPD-1B-365cm	365cm	75.4	12740	13455	13455	13130
	S5570-SPD-1B-393cm	393cm	81.2	13720	14490	14490	14140
	S5570-SPD-1B-421cm	421cm	87	14700	15525	15525	15150
S5570-SPD-1B-449cm	449cm	92.8	15680	16560	16560	16160	

Wattage: 20 W/m

Το φωτιστικό είναι διαθέσιμο σε μήκος πολλαπλάσιο των 14 εκατοστών
 The illuminant is available in lengths that are multiples of 14 centimeters.

LINEAR SUSPENDED 55×70 / Lumen output tables

CATEGORY 2A 350mA (2A)	SKU	Length	Wattage	Lumens 3000K	Lumens 4000K	Lumens 5000K	Lumens 6500K
	S5570-SPD-2A-57cm	57cm	23.6	4080	4380	4380	4080
	S5570-SPD-2A-85cm	85cm	35.4	6120	6570	6570	6120
	S5570-SPD-2A-113cm	113cm	47.2	8160	8760	8760	8160
	S5570-SPD-2A-141cm	141cm	59	10200	10950	10950	10200
	S5570-SPD-2A-169cm	169cm	70.8	12240	13140	13140	12240
	S5570-SPD-2A-197cm	197cm	82.6	14280	15330	15330	14280
	S5570-SPD-2A-225cm	225cm	94.4	16320	17520	17520	16320
	S5570-SPD-2A-253cm	253cm	106.2	18360	19710	19710	18360
	S5570-SPD-2A-281cm	281cm	118	20400	21900	21900	20400
	S5570-SPD-2A-309cm	309cm	129.8	22440	24090	24090	22440
	S5570-SPD-2A-337cm	337cm	141.6	24480	26280	26280	24480
	S5570-SPD-2A-365cm	365cm	153.4	26520	28470	28470	26520
	S5570-SPD-2A-393cm	393cm	165.2	28560	30660	30660	28560
	S5570-SPD-2A-421cm	421cm	177	30600	32850	32850	30600
S5570-SPD-2A-449cm	449cm	188.8	32640	35040	35040	32640	

Wattage: 40.5 W/m

CATEGORY 2B 500mA (2B)	SKU	Length	Wattage	Lumens 3000K	Lumens 4000K	Lumens 5000K	Lumens 6500K
	S5570-SPD-2B-57cm	57cm	35	5700	6140	6140	5700
	S5570-SPD-2B-85cm	85cm	52.5	8550	9210	9210	8550
	S5570-SPD-2B-113cm	113cm	70	11400	12280	12280	11400
	S5570-SPD-2B-141cm	141cm	87.5	14250	15350	15350	14250
	S5570-SPD-2B-169cm	169cm	105	17100	18420	18420	17100
	S5570-SPD-2B-197cm	197cm	122.5	19950	21490	21490	19950
	S5570-SPD-2B-225cm	225cm	140	22800	24560	24560	22800
	S5570-SPD-2B-253cm	253cm	157.5	25650	27630	27630	25650
	S5570-SPD-2B-281cm	281cm	175	28500	30700	30700	28500
	S5570-SPD-2B-309cm	309cm	192.5	31350	33770	33770	31350
	S5570-SPD-2B-337cm	337cm	210	34200	36840	36840	34200
	S5570-SPD-2B-365cm	365cm	227.5	37050	39910	39910	37050
	S5570-SPD-2B-393cm	393cm	245	39900	42980	42980	39900
	S5570-SPD-2B-421cm	421cm	262.5	42750	46050	46050	42750
S5570-SPD-2B-449cm	449cm	280	45600	49120	49120	45600	

Wattage: 60.5 W/m

Το φωτιστικό είναι διαθέσιμο σε μήκος πολλαπλάσιο των 14 εκατοστών

The illuminant is available in lengths that are multiples of 14 centimeters.

DARK LINEAR SUSPENDED 55×70 (SD5570-SPD)

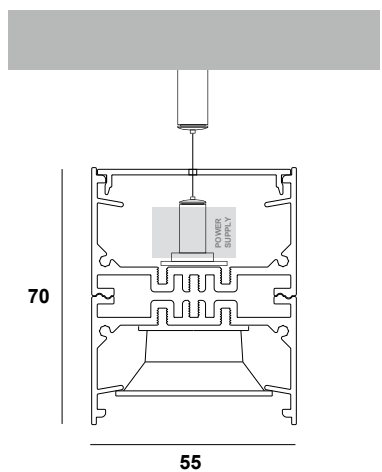



SD5570-SPD - XX - XX - XX - XX - XX - X - X

- (a) Κωδικός Γραμμικού / Linear Code
- (b) Κατηγορία / Category
- (c) Μήκος / Length
- (d) Θερμοκρασία φωτός / Color Temperature
- (e) Γωνία Δέσμης / Beam Angle
- (f) Χρώμα προφίλ / Profile Color
- (g) Χρώμα Ρεφλέκτορα / Reflector Color
- (h) Αυξομείωση έντασης φωτός / Dimming

Παράδειγμα κωδικού / Code example

DARK LINEAR SUSPENDED 55×70, 1A, 84.5cm, 3000K, 65D, Black, with Black Reflector, Dimmable
 SKU: SD5570-SPD-1A-84.5cm-30K-65D-BL-1-D

Material	PCB details	CRI	Lumen output / W
Extruded aluminium / Plastic	SMD light & dark 7×1	Ra>90 (Ra>80 on request)	up to 205 Lm/W

CCT	Beam angle	Profile color	Reflector color	Dimming options (D)
3000K (30K)	Medium 65D (65D)	Anodized (AN)	 Black (1)	Push
4000K (40K)		Black (BL)		DALI
5000K (50K)	Wide 90D (90D)	White (WH)	 White (2)	TRIAC 0/1-10V
6500K (65K)		RAL (RL)		CASAMBI
TUNABLE 2700K - 6500K (TN)		Graphite (GF)		Analog 0/1-10V
		Nickeling (NK)		
		Patina (PT)		

DARK LINEAR SUSPENDED 55×70 / Lumen output tables

CATEGORY 1A 350mA (1A)	SKU	Length	Wattage	Lumens 3000K (65D)	Lumens 3000K (90D)	Lumens 4000K (65D)	Lumens 4000K (90D)
	SD5570-SPD-1A-57cm	57cm	13.4	1702	1680	1774	1752
	SD5570-SPD-1A-85cm	85cm	20.1	2553	2520	2661	2628
	SD5570-SPD-1A-113cm	113cm	26.8	3404	3360	3548	3504
	SD5570-SPD-1A-141cm	141cm	33.5	4255	4200	4435	4380
	SD5570-SPD-1A-169cm	169cm	40.2	5106	5040	5322	5256
	SD5570-SPD-1A-197cm	197cm	46.9	5957	5880	6209	6132
	SD5570-SPD-1A-225cm	225cm	53.6	6808	6720	7096	7008
	SD5570-SPD-1A-253cm	253cm	60.3	7659	7560	7983	7884
	SD5570-SPD-1A-281cm	281cm	67	8510	8400	8870	8760
	SD5570-SPD-1A-309cm	309cm	73.7	9361	9240	9757	9636
	SD5570-SPD-1A-337cm	337m	80.4	10212	10080	10644	10512
	SD5570-SPD-1A-365cm	365m	87.1	11063	10920	11531	11388
	SD5570-SPD-1A-393cm	393cm	93.8	11914	11760	12418	12264
	SD5570-SPD-1A-421cm	421cm	100.5	12765	12600	13305	13140
SD5570-SPD-1A-449cm	449cm	107.2	13616	13440	14192	14016	

Wattage: 23 W/m

CATEGORY 1B 500mA (1B)	SD5570-SPD-1B-57cm	57cm	19.8	2398	2368	2512	2480
	SD5570-SPD-1B-85cm	85cm	29.7	3597	3552	3768	3720
	SD5570-SPD-1B-113cm	113cm	39.6	4796	4736	5024	4960
	SD5570-SPD-1B-141cm	141cm	49.5	5995	5920	6280	6200
	SD5570-SPD-1B-169cm	169cm	59.4	7194	7104	7536	7440
	SD5570-SPD-1B-197cm	197cm	69.3	8393	8288	8792	8680
	SD5570-SPD-1B-225cm	225cm	79.2	9592	9472	10048	9920
	SD5570-SPD-1B-253cm	253cm	89.1	10791	10656	11304	11160
	SD5570-SPD-1B-281cm	281cm	99	11990	11840	12560	12400
	SD5570-SPD-1B-309cm	309cm	108.9	13189	13024	13816	13640
	SD5570-SPD-1B-337cm	337m	118.8	14388	14208	15072	14880
	SD5570-SPD-1B-365cm	365m	128.7	15587	15392	16328	16120
	SD5570-SPD-1B-393cm	393cm	138.6	16786	16576	17584	17360
	SD5570-SPD-1B-421cm	421cm	148.5	17985	17760	18840	18600
	SD5570-SPD-1B-449cm	449cm	158.4	19184	18944	20096	19840

Wattage: 34 W/m

Το φωτιστικό είναι διαθέσιμο σε μήκος πολλαπλάσιο των 28 εκατοστών

The illuminant is available in lengths that are multiples of 28 centimeters.



Linears

SUSPENDED

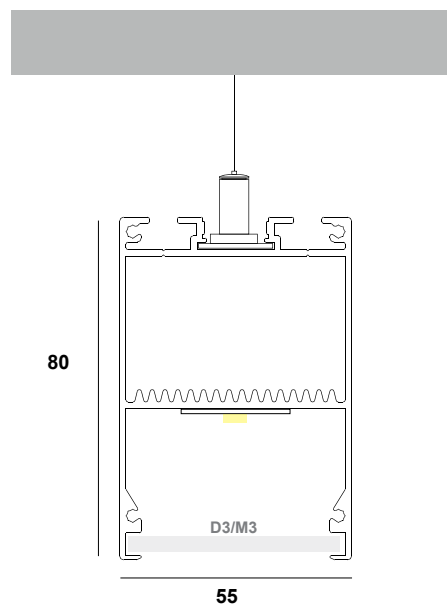



S5580-SPD - XX - XX - XX - XX - XX - X

- (a)
Κωδικός Γραμμικού
Linear Code
- (b)
Κατηγορία
Category
- (c)
Μήκος
Length
- (d)
Θερμοκρασία
φωτός
Color
Temperature
- (e)
Χρώμα
προφίλ
Profile
color
- (f)
Κάλυμμα
Cover
- (g)
Αυξομείωση
έντασης φωτός
Dimming

Παράδειγμα κωδικού / Code example

NILE SUSPENDED 55×80, 1A, 87cm, 3000K, Black, with Diffuser, Dimmable
SKU: S5580-SPD-1A-87cm-30K-D3-C1-D

Material	PCB details	CRI	Lumen output / W
Extruded aluminium	Zhaga-Compliant Dimensions	Ra>80 (Ra>90 on request)	up to 195 Lm/W

Covers	Profile color	CCT	Dimming options (D)
Diffuser 3mm (D3) 	Anodized (AN)	3000K (30K)	Push
	Black (BL)	4000K (40K)	DALI
	White (WH)	5000K (50K)	TRIAC 0/1-10V
Microprismatic 3mm (M3) 	RAL (RL)	6500K (65K)	CASAMBI
	Graphite (GF)	TUNABLE 2700K - 6500K (TN)	Analog 0/1-10V
	Nickeling (NK)		
	Patina (PT)		

NILE SUSPENDED 55×80 / Lumen output tables

CATEGORY 1A 350mA (1A)	SKU	Length	Wattage	Lumens 3000K	Lumens 4000K	Lumens 5000K	Lumens 6500K
	S5580-SPD-1A-59cm	59cm	7.8	1390	1470	1470	1440
	S5580-SPD-1A-87cm	87cm	11.7	2085	2205	2205	2160
	S5580-SPD-1A-115cm	115cm	15.6	2780	2940	2940	2880
	S5580-SPD-1A-143cm	143cm	19.5	3475	3675	3675	3600
	S5580-SPD-1A-171cm	171cm	23.4	4170	4410	4410	4320
	S5580-SPD-1A-199cm	199cm	27.3	4865	5145	5145	5040
	S5580-SPD-1A-227cm	227cm	31.2	5560	5880	5880	5760
	S5580-SPD-1A-255cm	255cm	35.1	6255	6615	6615	6480
	S5580-SPD-1A-283cm	283cm	39	6950	7350	7350	7200
	S5580-SPD-1A-311cm	311cm	42.9	7645	8085	8085	7920
	S5580-SPD-1A-339cm	339cm	46.8	8340	8820	8820	8640
	S5580-SPD-1A-367cm	367cm	50.7	9035	9555	9555	9360
	S5580-SPD-1A-395cm	395cm	54.6	9730	10290	10290	10080
	S5580-SPD-1A-423cm	423cm	58.5	10425	11025	11025	10800
S5580-SPD-1A-451cm	451cm	62.4	11120	11760	11760	11520	

Wattage: 13.5 W/m

CATEGORY 1B 500mA (1B)	SKU	Length	Wattage	Lumens 3000K	Lumens 4000K	Lumens 5000K	Lumens 6500K
	S5580-SPD-1B-59cm	59cm	11.6	1960	2070	2070	2020
	S5580-SPD-1B-87cm	87cm	17.4	2940	3105	3105	3030
	S5580-SPD-1B-115cm	115cm	23.2	3920	4140	4140	4040
	S5580-SPD-1B-143cm	143cm	29	4900	5175	5175	5050
	S5580-SPD-1B-171cm	171cm	34.8	5880	6210	6210	6060
	S5580-SPD-1B-199cm	199cm	40.6	6860	7245	7245	7070
	S5580-SPD-1B-227cm	227cm	46.4	7840	8280	8280	8080
	S5580-SPD-1B-255cm	255cm	52.2	8820	9315	9315	9090
	S5580-SPD-1B-283cm	283cm	58	9800	10350	10350	10100
	S5580-SPD-1B-311cm	311cm	63.8	10780	11385	11385	11110
	S5580-SPD-1B-339cm	339cm	69.6	11760	12420	12420	12120
	S5580-SPD-1B-367cm	367cm	75.4	12740	13455	13455	13130
	S5580-SPD-1B-395cm	395cm	81.2	13720	14490	14490	14140
	S5580-SPD-1B-423cm	423cm	87	14700	15525	15525	15150
S5580-SPD-1B-451cm	451cm	92.8	15680	16560	16560	16160	

Wattage: 20 W/m

Το φωτιστικό είναι διαθέσιμο σε μήκος πολλαπλάσιο των 14 εκατοστών
 The illuminant is available in lengths that are multiples of 14 centimeters.

NILE SUSPENDED 55×80 / Lumen output tables

SKU	Length	Wattage	Lumens 3000K	Lumens 4000K	Lumens 5000K	Lumens 6500K
S5580-SPD-2A-59cm	59cm	23.6	4080	4380	4380	4080
S5580-SPD-2A-87cm	87cm	35.4	6120	6570	6570	6120
S5580-SPD-2A-115cm	115cm	47.2	8160	8760	8760	8160
S5580-SPD-2A-143cm	143cm	59	10200	10950	10950	10200
S5580-SPD-2A-171cm	171cm	70.8	12240	13140	13140	12240
S5580-SPD-2A-199cm	199cm	82.6	14280	15330	15330	14280
S5580-SPD-2A-227cm	227cm	94.4	16320	17520	17520	16320
S5580-SPD-2A-255cm	255cm	106.2	18360	19710	19710	18360
S5580-SPD-2A-283cm	283cm	118	20400	21900	21900	20400
S5580-SPD-2A-311cm	311cm	129.8	22440	24090	24090	22440
S5580-SPD-2A-339cm	339cm	141.6	24480	26280	26280	24480
S5580-SPD-2A-367cm	367cm	153.4	26520	28470	28470	26520
S5580-SPD-2A-395cm	395cm	165.2	28560	30660	30660	28560
S5580-SPD-2A-423cm	423cm	177	30600	32850	32850	30600
S5580-SPD-2A-451cm	451cm	188.8	32640	35040	35040	32640

Wattage: 40.5 W/m

S5580-SPD-2B-59cm	59cm	35	5700	6140	6140	5700
S5580-SPD-2B-87cm	87cm	52.5	8550	9210	9210	8550
S5580-SPD-2B-115cm	115cm	70	11400	12280	12280	11400
S5580-SPD-2B-143cm	143cm	87.5	14250	15350	15350	14250
S5580-SPD-2B-171cm	171cm	105	17100	18420	18420	17100
S5580-SPD-2B-199cm	199cm	122.5	19950	21490	21490	19950
S5580-SPD-2B-227cm	227cm	140	22800	24560	24560	22800
S5580-SPD-2B-255cm	255cm	157.5	25650	27630	27630	25650
S5580-SPD-2B-283cm	283cm	175	28500	30700	30700	28500
S5580-SPD-2B-311cm	311cm	192.5	31350	33770	33770	31350
S5580-SPD-2B-339cm	339cm	210	34200	36840	36840	34200
S5580-SPD-2B-367cm	367cm	227.5	37050	39910	39910	37050
S5580-SPD-2B-395cm	395cm	245	39900	42980	42980	39900
S5580-SPD-2B-423cm	423cm	262.5	42750	46050	46050	42750
S5580-SPD-2B-451cm	451cm	280	45600	49120	49120	45600

Wattage: 60.5 W/m

Το φωτιστικό είναι διαθέσιμο σε μήκος πολλαπλάσιο των 14 εκατοστών

The illuminant is available in lengths that are multiples of 14 centimeters.



Linears

SUSPENDED

UPDOWN



LINEAR UPDOWN 55×70 (U5570-SPD)

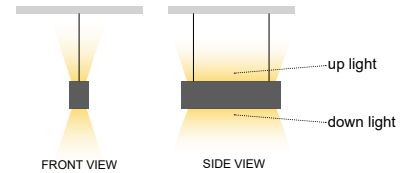
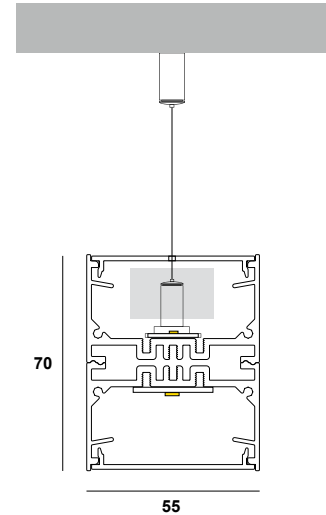

U5570-SPD - XX - XX - XX - XX - XX - XX - XX - X

- (a) Κωδικός Γραμμικού
Linear Code
- (b) Κατηγορία
downlight
Category
downlight
- (c) Ισχύς
uplight
Wattage
uplight
- (d) Μήκος
Length
- (e) CCT
downlight
- (f) CCT
uplight
- (g) Χρώμα
προφίλ
Profile
color
- (h) Κάλυμμα
Cover
- (i) Αυτομείωση
έντασης
φωτός
Dimming

Παράδειγμα κωδικού / Code example

LINEAR UPDOWN, 55×70 1A, 6W/m, 85cm, Downlight 3000K, Uplight 3000K, Black, with Acrylic Diffuser, Dimmable
SKU: U5570-SPD-1A-6W-85cm-30K-30K-BL-AD-D

Material	PCB details	CRI	Lumen output / W	Dimming options
Extruded aluminium	Zhaga-Compliant Dimensions	Ra>80 (Ra>90 on request)	up to 195 Lm/W	Push DALI TRIAC 0/1-10V CASAMBI Analog 0/1-10V

CCT down lighting	Wattage up lighting	CCT up lighting	Profile color	Covers for down lighting
3000K (30K)	6 W/m White (6W)	3000K (30K) for up lighting 6W 9W 12W	Anodized (AN)	Acrylic Diffuser (AD)
4000K (40K)	9 W/m White (9W)	4000K (40K) for up lighting 6W 9W 12W	Black (BL)	
5000K (50K)	12 W/m White (12W)	5000K (50K) for up lighting 6W 9W 12W	White (WH)	
6500K (65K)	12 W/m RGBW (12C)	6500K (65K) for up lighting 6W 9W 12W	RAL (RL)	Acrylic Microprismatic (AM)
TUNABLE 2700K - 6500K (TN)	16 W/m RGB (16C)	RGBCW (C2) for up lighting 12C	Graphite (GF)	
	16 W/m TUNABLE (16W)	RGBWW (C3) for up lighting 12C	Nickeling (NK)	
		RGB for up lighting 16C	Patina (PT)	
		TUNABLE 2700K - 6500K (TN)		

DOWN LIGHT WATTAGE - LUMENS TABLE

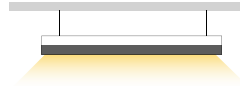

CATEGORY 1A 350mA (1A)	SKU	Length	Wattage	Lumens 3000K	Lumens 4000K	Lumens 5000K	Lumens 6500K
	U5570-SPD-1A-__-57cm	57cm	7.8	1390	1470	1470	1440
	U5570-SPD-1A-__-85cm	85cm	11.7	2085	2205	2205	2160
	U5570-SPD-1A-__-113cm	113cm	15.6	2780	2940	2940	2880
	U5570-SPD-1A-__-141cm	141cm	19.5	3475	3675	3675	3600
	U5570-SPD-1A-__-169cm	169cm	23.4	4170	4410	4410	4320
	U5570-SPD-1A-__-197cm	197cm	27.3	4865	5145	5145	5040
	U5570-SPD-1A-__-225cm	225cm	31.2	5560	5880	5880	5760
	U5570-SPD-1A-__-253cm	253cm	35.1	6255	6615	6615	6480
	U5570-SPD-1A-__-281cm	281cm	39	6950	7350	7350	7200
	U5570-SPD-1A-__-309cm	309cm	42.9	7645	8085	8085	7920
	U5570-SPD-1A-__-337cm	337cm	46.8	8340	8820	8820	8640
	U5570-SPD-1A-__-365cm	365cm	50.7	9035	9555	9555	9360
	U5570-SPD-1A-__-393cm	393cm	54.6	9730	10290	10290	10080
	U5570-SPD-1A-__-421cm	421cm	58.5	10425	11025	11025	10800
U5570-SPD-1A-__-449cm	449cm	62.4	11120	11760	11760	11520	

CATEGORY 1B 500mA (1B)	SKU	Length	Wattage	Lumens 3000K	Lumens 4000K	Lumens 5000K	Lumens 6500K
	U5570-SPD-1B-__-57cm	57cm	11.6	1960	2070	2070	2020
	U5570-SPD-1B-__-85cm	85cm	17.4	2940	3105	3105	3030
	U5570-SPD-1B-__-113cm	113cm	23.2	3920	4140	4140	4040
	U5570-SPD-1B-__-141cm	141cm	29	4900	5175	5175	5050
	U5570-SPD-1B-__-169cm	169cm	34.8	5880	6210	6210	6060
	U5570-SPD-1B-__-197cm	197cm	40.6	6860	7245	7245	7070
	U5570-SPD-1B-__-225cm	225cm	46.4	7840	8280	8280	8080
	U5570-SPD-1B-__-253cm	253cm	52.2	8820	9315	9315	9090
	U5570-SPD-1B-__-281cm	281cm	58	9800	10350	10350	10100
	U5570-SPD-1B-__-309cm	309cm	63.8	10780	11385	11385	11110
	U5570-SPD-1B-__-337cm	337cm	69.6	11760	12420	12420	12120
	U5570-SPD-1B-__-365cm	365cm	75.4	12740	13455	13455	13130
	U5570-SPD-1B-__-393cm	393cm	81.2	13720	14490	14490	14140
	U5570-SPD-1B-__-421cm	421cm	87	14700	15525	15525	15150
U5570-SPD-1B-__-449cm	449cm	92.8	15680	16560	16560	16160	

Το φωτιστικό είναι διαθέσιμο σε μήκος πολλαπλάσιο των 14 εκατοστών
 The illuminant is available in lengths that are multiples of 14 centimeters.

DOWN LIGHT WATTAGE - LUMENS TABLE

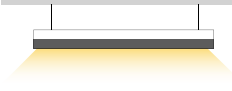

SKU	Length	Wattage	Lumens 3000K	Lumens 4000K	Lumens 5000K	Lumens 6500K
U5570-SPD-2A-__-57cm	57cm	23.6	4080	4380	4380	4080
U5570-SPD-2A-__-85cm	85cm	35.4	6120	6570	6570	6120
U5570-SPD-2A-__-113cm	113cm	47.2	8160	8760	8760	8160
U5570-SPD-2A-__-141cm	141cm	59	10200	10950	10950	10200
U5570-SPD-2A-__-169cm	169cm	70.8	12240	13140	13140	12240
U5570-SPD-2A-__-197cm	197cm	82.6	14280	15330	15330	14280
U5570-SPD-2A-__-225cm	225cm	94.4	16320	17520	17520	16320
U5570-SPD-2A-__-253cm	253cm	106.2	18360	19710	19710	18360
U5570-SPD-2A-__-281cm	281cm	118	20400	21900	21900	20400
U5570-SPD-2A-__-309cm	309cm	129.8	22440	24090	24090	22440
U5570-SPD-2A-__-337cm	337cm	141.6	24480	26280	26280	24480
U5570-SPD-2A-__-365cm	365cm	153.4	26520	28470	28470	26520
U5570-SPD-2A-__-393cm	393cm	165.2	28560	30660	30660	28560
U5570-SPD-2A-__-421cm	421cm	177	30600	32850	32850	30600
U5570-SPD-2A-__-449cm	449cm	188.8	32640	35040	35040	32640

SKU	Length	Wattage	Lumens 3000K	Lumens 4000K	Lumens 5000K	Lumens 6500K
U5570-SPD-2B-__-57cm	57cm	35	5700	6140	6140	5700
U5570-SPD-2B-__-85cm	85cm	52.5	8550	9210	9210	8550
U5570-SPD-2B-__-113cm	113cm	70	11400	12280	12280	11400
U5570-SPD-2B-__-141cm	141cm	87.5	14250	15350	15350	14250
U5570-SPD-2B-__-169cm	169cm	105	17100	18420	18420	17100
U5570-SPD-2B-__-197cm	197cm	122.5	19950	21490	21490	19950
U5570-SPD-2B-__-225cm	225cm	140	22800	24560	24560	22800
U5570-SPD-2B-__-253cm	253cm	157.5	25650	27630	27630	25650
U5570-SPD-2B-__-281cm	281cm	175	28500	30700	30700	28500
U5570-SPD-2B-__-309cm	309cm	192.5	31350	33770	33770	31350
U5570-SPD-2B-__-337cm	337cm	210	34200	36840	36840	34200
U5570-SPD-2B-__-365cm	365cm	227.5	37050	39910	39910	37050
U5570-SPD-2B-__-393cm	393cm	245	39900	42980	42980	39900
U5570-SPD-2B-__-421cm	421cm	262.5	42750	46050	46050	42750
U5570-SPD-2B-__-449cm	449cm	280	45600	49120	49120	45600



UP LIGHT OPTIONS

White

LED STRIP 6W/m White (6W)	Length	Wattage	CCT
	57cm	3.6	3000K (3) 4000K (4) 5000K (5) 6500K (6)
	85cm	5.3	
	113cm	7	
	141cm	8.6	
	169cm	10.3	
	197cm	12	
	225cm	13.7	
	253cm	15.4	
	281cm	17	
	309cm	18.7	
	337cm	20.4	
	365cm	22.1	
	393cm	23.8	
	421cm	25.4	
449cm	28.6		

LED STRIP 9W/m White (9W)	Length	Wattage	CCT
	57cm	5.4	3000K (3) 4000K (4) 5000K (5) 6500K (6)
	85cm	7.9	
	113cm	10.4	
	141cm	13	
	169cm	15.5	
	197cm	18	
	225cm	20.5	
	253cm	23	
	281cm	25.6	
	309cm	28.1	
	337cm	30.6	
	365cm	33.1	
	393cm	35.6	
	421cm	38.2	
449cm	42.8		

LED STRIP 12W/m White (12W)	Length	Wattage	CCT
	57cm	7.2	3000K (3) 4000K (4) 5000K (5) 6500K (6)
	85cm	10.6	
	113cm	13.9	
	141cm	17.3	
	169cm	20.6	
	197cm	24	
	225cm	27.4	
	253cm	30.7	
	281cm	34.1	
	309cm	37.4	
	337cm	40.8	
	365cm	44.2	
	393cm	47.5	
	421cm	50.9	
449cm	57.1		

Color

LED STRIP 12W/m RGBW (12C)	Length	Wattage	CCT
	57cm	7.2	RGB + 6500K (C2) RGB + 3000K (C3)
	85cm	10.6	
	113cm	13.9	
	141cm	17.3	
	169cm	20.6	
	197cm	24	
	225cm	27.4	
	253cm	30.7	
	281cm	34.1	
	309cm	37.4	
	337cm	40.8	
	365cm	44.2	
	393cm	47.5	
	421cm	50.8	
449cm	57.1		

LED STRIP 16W/m RGB (16C)	Length	Wattage	CCT uplighting
	57cm	9.6	RGB
	85cm	14.1	
	113cm	18.6	
	141cm	23	
	169cm	27.5	
	197cm	32	
	225cm	36.5	
	253cm	41	
	281cm	45.4	
	309cm	49.9	
	337cm	54.4	
	365cm	58.9	
	393cm	63.4	
	421cm	67.8	
449cm	76.2		



DARK LINEAR UPDOWN 55×70 (UD5570-SPD)

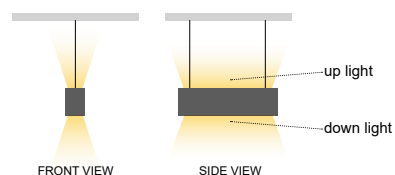
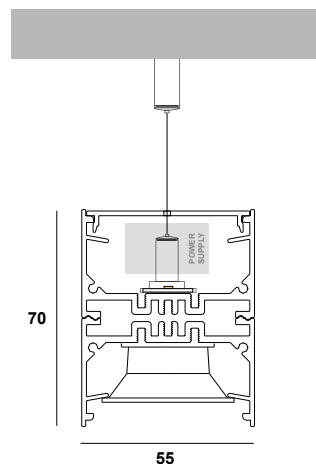

UD5570-SPD - **XX** - **XX** - XX - XX - XX - XX - XX - X - X

- (a) Κωδικός Γραμμικού / Linear Code
- (b) Κατηγορία downlight / Category downlight
- (c) Ισχύς uplight / Wattage uplight
- (d) Μήκος / Length
- (e) CCT downlight
- (f) CCT uplight
- (g) Γωνία δέσμης / Beam angle
- (h) Χρώμα προφίλ / Profile color
- (i) Χρώμα Ρεφλέκτορα / Reflector color
- (j) Αυτομείωση έντασης φωτός / Dimming

Παράδειγμα κωδικού / Code example

DARK LINEAR UPDOWN 55×70, 1A, 6W/m, 84.5cm, Downlight 3000K, Uplight 3000K, 65D, Black, with Black Reflector, Dimmable
 SKU: UD5570-SPD-1A-6W-85cm-30K-30K-65D-BL-1-D

Material	Profile color	Reflector color	PCB details	Dimming options
Extruded aluminium / Plastic	Anodized (AN)	Black (1)	SMD light & dark 7×1	Push
	Black (BL)			DALI
	White (WH)			TRIAC 0/1-10V
	RAL (RL)	White (2)		CASAMBI
	Nickeling (NK)			Analog 0/1-10V
	Patina (PT)			

CCT down lighting	Beam angle down lighting	CRI	Lumen output / W	Wattage up lighting	CCT up lighting
3000K (30K)	Medium 65D (65D)	Ra>90 (Ra>80 on request)	up to 205 Lm/W	6 W/m White (6W)	3000K (30K) for up lighting 6W 9W 12W
4000K (40K)	Wide 90D (90D)			9 W/m White (9W)	4000K (40K) for up lighting 6W 9W 12W
5000K (50K)				12 W/m White (12W)	5000K (50K) for up lighting 6W 9W 12W
6500K (65K)				12 W/m RGBW (12C)	6500K (65K) for up lighting 6W 9W 12W
TUNABLE 2700K - 6500K (TN)				16 W/m RGB (16C)	RGBCW (C2) for up lighting 12C
				16 W/m TUNABLE (16W)	RGBWW (C3) for up lighting 12C
			RGB for up lighting 16C		
			TUNABLE 2700K - 6500K (TN)		



Linears

UPDOWN

89

BARISLIGHT

DOWN LIGHT WATTAGE - LUMENS TABLE

SKU	Length	Wattage	Lumens 3000K (65D)	Lumens 3000K (90D)	Lumens 4000K (65D)	Lumens 4000K (90D)
UD5570-SPD-1A-_-56.5cm	56.5cm	13.4	1702	1680	1774	1752
UD5570-SPD-1A-_-84.5cm	84.5cm	20.1	2553	2520	2661	2628
UD5570-SPD-1A-_-112.5cm	112.5cm	26.8	3404	3360	3548	3504
UD5570-SPD-1A-_-140.5cm	140.5cm	33.5	4255	4200	4435	4380
UD5570-SPD-1A-_-168.5cm	168.5cm	40.2	5106	5040	5322	5256
UD5570-SPD-1A-_-196.5cm	196.5cm	46.9	5957	5880	6209	6132
UD5570-SPD-1A-_-224.5cm	224.5cm	53.6	6808	6720	7096	7008
UD5570-SPD-1A-_-252.5cm	252.5cm	60.3	7659	7560	7983	7884
UD5570-SPD-1A-_-280.5cm	280.5cm	67	8510	8400	8870	8760
UD5570-SPD-1A-_-308.5cm	308.5cm	73.7	9361	9240	9757	9636
UD5570-SPD-1A-_-336.5cm	336.5cm	80.4	10212	10080	10644	10512
UD5570-SPD-1A-_-364.5cm	364.5cm	87.1	11063	10920	11531	11388
UD5570-SPD-1A-_-392.5cm	392.5cm	93.8	11914	11760	12418	12264
UD5570-SPD-1A-_-420.5cm	420.5cm	100.5	12765	12600	13305	13140
UD5570-SPD-1A-_-448.5cm	448.5cm	107.2	13616	13440	14192	14016

SKU	Length	Wattage	Lumens 3000K (65D)	Lumens 3000K (90D)	Lumens 4000K (65D)	Lumens 4000K (90D)
UD5570-SPD-1B-_-56.5cm	56.5cm	19.8	2398	2368	2512	2480
UD5570-SPD-1B-_-84.5cm	84.5cm	29.7	3597	3552	3768	3720
UD5570-SPD-1B-_-112.5cm	112.5cm	39.6	4796	4736	5024	4960
UD5570-SPD-1B-_-140.5cm	140.5cm	49.5	5995	5920	6280	6200
UD5570-SPD-1B-_-168.5cm	168.5cm	59.4	7194	7104	7536	7440
UD5570-SPD-1B-_-196.5cm	196.5cm	69.3	8393	8288	8792	8680
UD5570-SPD-1B-_-224.5cm	224.5cm	79.2	9592	9472	10048	9920
UD5570-SPD-1B-_-252.5cm	252.5cm	89.1	10791	10656	11304	11160
UD5570-SPD-1B-_-280.5cm	280.5cm	99	11990	11840	12560	12400
UD5570-SPD-1B-_-308.5cm	308.5cm	108.9	13189	13024	13816	13640
UD5570-SPD-1B-_-336.5cm	336.5cm	118.8	14388	14208	15072	14880
UD5570-SPD-1B-_-364.5cm	364.5cm	128.7	15587	15392	16328	16120
UD5570-SPD-1B-_-392.5cm	392.5cm	138.6	16786	16576	17584	17360
UD5570-SPD-1B-_-420.5cm	420.5cm	148.5	17985	17760	18840	18600
UD5570-SPD-1A-_-448.5cm	448.5cm	158.4	19184	18944	20096	19840

Το φωτιστικό είναι διαθέσιμο σε μήκος πολλαπλάσιο των 28 εκατοστών

The illuminant is available in lengths that are multiples of 28 centimeters.



White

LED STRIP 6W/m White (6W)	Length	Wattage	CCT
	56.5cm	3.6	3000K (3) 4000K (4) 5000K (5) 6500K (6)
	84.5cm	5.3	
	112.5cm	7	
	140.5cm	8.6	
	168.5cm	10.3	
	196.5cm	12	
	224.5cm	13.7	
	252.5cm	15.4	
	280.5cm	17	
	308.5cm	18.7	
	336.5cm	20.4	
	364.5cm	22.1	
	392.5cm	23.8	
420.5cm	25.4		
448.5cm	28.6		

LED STRIP 9W/m White (9W)	Length	Wattage	CCT
	56.5cm	5.4	3000K (3) 4000K (4) 5000K (5) 6500K (6)
	84.5cm	7.9	
	112.5cm	10.4	
	140.5cm	13	
	168.5cm	15.5	
	196.5cm	18	
	224.5cm	20.5	
	252.5cm	23	
	280.5cm	25.6	
	308.5cm	28.1	
	336.5cm	30.6	
	364.5cm	33.1	
	392.5cm	35.6	
420.5cm	38.2		
448.5cm	42.8		

LED STRIP 12W/m White (12W)	Length	Wattage	CCT
	56.5cm	7.2	3000K (3) 4000K (4) 5000K (5) 6500K (6)
	84.5cm	10.6	
	112.5cm	13.9	
	140.5cm	17.3	
	168.5cm	20.6	
	196.5cm	24	
	224.5cm	27.4	
	252.5cm	30.7	
	280.5cm	34.1	
	308.5cm	37.4	
	336.5cm	40.8	
	364.5cm	44.2	
	392.5cm	47.5	
420.5cm	50.9		
448.5cm	57.1		

Color

LED STRIP 12W/m RGBW (12C)	Length	Wattage	CCT
	56.5cm	7.2	RGB + 6500K (C2) RGB + 3000K (C3)
	84.5cm	10.6	
	112.5cm	13.9	
	140.5cm	17.3	
	168.5cm	20.6	
	196.5cm	24	
	224.5cm	27.4	
	252.5cm	30.7	
	280.5cm	34.1	
	308.5cm	37.4	
	336.5cm	40.8	
	364.5cm	44.2	
	392.5cm	47.5	
420.5cm	50.8		
448.5cm	57.1		

LED STRIP 16W/m RGB (16C)	Length	Wattage	CCT uplighting
	56.5cm	9.6	RGB
	84.5cm	14.1	
	112.5cm	18.6	
	140.5cm	23	
	168.5cm	27.5	
	196.5cm	32	
	224.5cm	36.5	
	252.5cm	41	
	280.5cm	45.4	
	308.5cm	49.9	
	336.5cm	54.4	
	364.5cm	58.9	
	392.5cm	63.4	
420.5cm	67.8		
448.5cm	76.2		

Το φωτιστικό είναι διαθέσιμο σε μήκος πολλαπλάσιο των 28 εκατοστών
 The illuminant is available in lengths that are multiples of 28 centimeters.



CURVE

LIGHTING SYSTEMS



CIRCLES

Τα Circle® είναι ιδανικά για το φωτισμό μεγάλων επιφανειών. Μπορούν να χρησιμοποιηθούν σε δημόσια πολιτιστικά κτίρια, μουσεία και γκαλερί. Είναι ένα φωτιστικό που χρησιμοποιείται κυρίως από τους σχεδιαστές φωτισμού για να αναδείξουν επιφάνειες κτιρίων ή αρχιτεκτονικές κατασκευές. Αναζητώντας συνεχώς απλούστερους και πρακτικούς τρόπους για τη δημιουργία προφίλ φωτιστικών που να εφαρμόζουν όσο πιο εύκολα γίνεται, η **BARISLIGHT®** κατέληξε σε μια καινοτόμα ιδέα κυκλικών φωτιστικών που μπορεί να προσφέρει εξαιρετική φωτεινότητα και στυλ στο χώρο.

Circle® are ideal for lighting large surfaces. They can be used in public cultural buildings, museums and galleries. It is a luminaire mainly used by lighting designers to highlight building surfaces or architectural structures. Constantly looking for simpler and more practical ways to create lighting profiles that fit as easily as possible, **BARISLIGHT®** has come up with an innovative concept of circular lighting that can provide exceptional brightness and style to the space.

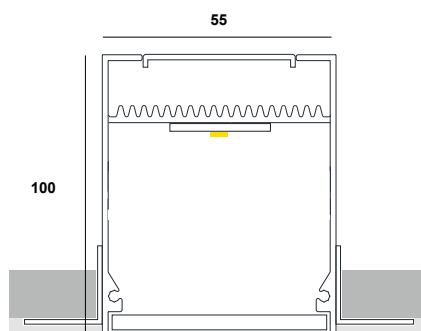

TC55100-TR - XX - XXX - XX - X

(a) Κωδικός Γραμμικού / Linear Code
 (b) Κατηγορία / Category
 (c) Διάμετρος / Diameter
 (d) Θερμοκρασία φωτός / Color Temperature
 (e) Αυξομείωση έντασης φωτός / Dimming

Παράδειγμα κωδικού / Code example

CIRCLE TRIMLESS 55×100, 1A, Ø90cm, 3000K, Dimmable
 SKU: TC55100-TR-1A-90cm-30K-D

Material	PCB details	CRI	Lumen output / W
Extruded aluminium	Zhaga-Compliant Dimensions	Ra>80 (Ra>90 on request)	up to 195 Lm/W

Covers	CCT	Dimming options (D)
 Diffuser 5mm	3000K (30K)	Push
	4000K (40K)	DALI
	5000K (50K)	TRIAC 0/1-10V
	6500K (65K)	CASAMBI
	TUNABLE 2700K - 6500K (TN)	Analog 0/1-10V



Linears

CIRCLES

95

BARISLIGHT

CIRCLE TRIMLESS 55×100 / Lumen output tables

CATEGORY 1A 350mA (1A)	SKU	diameter	Wattage	Lumens 3000K	Lumens 4000K	Lumens 5000K	Lumens 6500K
	TC55100-TR-1A-50cm	50cm	18	3150	3330	3330	3240
	TC55100-TR-1A-60cm	60cm	22	3850	4070	4070	3960
	TC55100-TR-1A-70cm	70cm	28	4900	5180	5180	5040
	TC55100-TR-1A-80cm	80cm	32	5600	5920	5920	5760
	TC55100-TR-1A-90cm	90cm	36	6300	6660	6660	6480
	TC55100-TR-1A-100cm	100cm	40	7000	7400	7400	7200
	TC55100-TR-1A-110cm	110cm	44	7700	8140	8140	7920
	TC55100-TR-1A-120cm	120cm	48	8400	8880	8880	8640
	TC55100-TR-1A-130cm	130cm	52	9100	9620	9620	9360
	TC55100-TR-1A-140cm	140cm	56	9800	10360	10360	10080
	TC55100-TR-1A-150cm	150cm	64	11200	11840	11840	11520
	TC55100-TR-1A-160cm	160cm	68	11900	12580	12580	12240
	TC55100-TR-1A-170cm	170cm	72	12600	13320	13320	12960
TC55100-TR-1A-180cm	180cm	76	13300	14060	14060	13680	

CATEGORY 1B 500mA (1B)	TC55100-TR-1B-50cm	50cm	26.1	4410	4680	4680	4545
	TC55100-TR-1B-60cm	60cm	31.9	5390	5720	5720	5555
	TC55100-TR-1B-70cm	70cm	40.6	6860	7280	7280	7070
	TC55100-TR-1B-80cm	80cm	46.4	7840	8320	8320	8080
	TC55100-TR-1B-90cm	90cm	52.2	8820	9360	9360	9090
	TC55100-TR-1B-100cm	100cm	58	9800	10400	10400	10100
	TC55100-TR-1B-110cm	110cm	63.8	10780	11440	11440	11110
	TC55100-TR-1B-120cm	120cm	69.6	11760	12480	12480	12120
	TC55100-TR-1B-130cm	130cm	75.4	12740	13520	13520	13130
	TC55100-TR-1B-140cm	140cm	81.2	13720	14560	14560	14140
	TC55100-TR-1B-150cm	150cm	92.8	15680	16640	16640	16160
	TC55100-TR-1B-160cm	160cm	98.6	16660	17680	17680	17170
	TC55100-TR-1B-170cm	170cm	104.4	17640	18720	18720	18180
	TC55100-TR-1B-180cm	180cm	110.2	18620	19760	19760	19190

CIRCLE TRIMLESS 55×100 / Lumen output tables

CATEGORY 2A 350mA (2A)	SKU	diameter	Wattage	Lumens 3000K	Lumens 4000K	Lumens 5000K	Lumens 6500K
	TC55100-TR-2A-50cm	50cm	36	6300	6660	6660	6480
	TC55100-TR-2A-60cm	60cm	44	7700	8140	8140	7920
	TC55100-TR-2A-70cm	70cm	56	9800	10360	10360	10080
	TC55100-TR-2A-80cm	80cm	64	11200	11840	11840	11520
	TC55100-TR-2A-90cm	90cm	72	12600	13320	13320	12960
	TC55100-TR-2A-100cm	100cm	80	14000	14800	14800	14400
	TC55100-TR-2A-110cm	110cm	88	15400	16280	16280	15840
	TC55100-TR-2A-120cm	120cm	96	16800	17760	17760	17280
	TC55100-TR-2A-130cm	130cm	104	18200	19240	19240	18720
	TC55100-TR-2A-140cm	140cm	112	19600	20720	20720	20160
	TC55100-TR-2A-150cm	150cm	128	22400	23680	23680	23040
	TC55100-TR-2A-160cm	160cm	136	23800	25160	25160	24480
TC55100-TR-2A-170cm	170cm	144	25200	26640	26640	25920	
TC55100-TR-2A-180cm	180cm	152	26600	28120	28120	27360	

CATEGORY 2B 500mA (2B)	TC55100-TR-2B-50cm	50cm	52.2	8820	9360	9360	9090
	TC55100-TR-2B-60cm	60cm	63.8	10780	11440	11440	11110
	TC55100-TR-2B-70cm	70cm	81.2	13720	14560	14560	14140
	TC55100-TR-2B-80cm	80cm	92.8	15680	16640	16640	16160
	TC55100-TR-2B-90cm	90cm	104.4	17640	18720	18720	18180
	TC55100-TR-2B-100cm	100cm	116	19600	20800	20800	20200
	TC55100-TR-2B-110cm	110cm	127.6	21560	22880	22880	22220
	TC55100-TR-2B-120cm	120cm	139.2	23520	24960	24960	24240
	TC55100-TR-2B-130cm	130cm	150.8	25480	27040	27040	26260
	TC55100-TR-2B-140cm	140cm	162.4	27440	29120	29120	28280
	TC55100-TR-2B-150cm	150cm	185.6	31360	33280	33280	32320
	TC55100-TR-2B-160cm	160cm	197.2	33320	35360	35360	34340
	TC55100-TR-2B-170cm	170cm	208.8	35280	37440	37440	36360
TC55100-TR-2B-180cm	180cm	220.4	37240	39520	39520	38380	

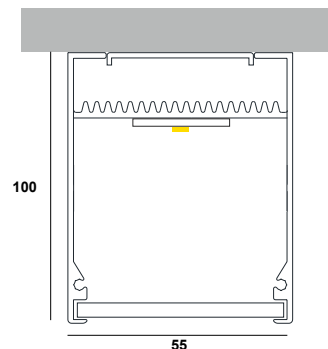

C55100-SF - XX - XXX - X - XX - X - XXX





(a)	(b)	(c)	(d)	(e)	(f)	(g)
Κωδικός Γραμμικού Linear Code	Κατηγορία απόδοσης Output category	Διάμετρος Diameter	Θερμοκρασία φωτός Color temperature	Χρώμα προφίλ Profile color	Αυξομείωση έντασης φωτός Dimming	Τοποθέτηση τροφοδοτικού Power supply placement

Παράδειγμα κωδικού / Code example

CIRCLE SURFACE 55×100, 1A, Ø90cm, 3000K, Black, Dimmable, Hidden Power supply
SKU: C55100-SF-1A-90cm-30K-BL-D-HP

Material	PCB details	CRI	Lumen output / W
Extruded aluminium	Zhaga-Compliant Dimensions	Ra>80 (Ra>90 on request)	up to 195 Lm/W

Covers	CCT	Profile color	Dimming options (D)
 Diffuser 5mm	3000K (30K)	Anodized (AN)	Push
	4000K (40K)	Black (BL)	DALI
	5000K (50K)	White (WH)	TRIAC 0/1-10V
	6500K (65K)	RAL (RL)	CASAMBI
	TUNABLE 2700K - 6500K (TN)	Graphite (GF)	Analog 0/1-10V
		Nickeling (NK)	
	Patina (PT)		

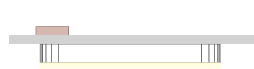
power supply installation	
Μέσα σε ροζέτα Inside a rosette 	 Κυκλική ροζέτα Ø400×40mm Circular rosette Ø400×40mm (RP4)  Ορθογώνια ροζέτα 400×60×35mm Rectangular rosette 400×60×35mm (RP5)  Ορθογώνια ροζέτα 600×80×35mm Rectangular rosette 600×80×35mm (RP6)
	Κρυφό με καταπακτή πρόσβασης Hidden with access hatch  (HP)



Linears

CIRCLES

99

BARISLIGHT

CIRCLE SURFACE 55×100 / Lumen output tables

CATEGORY 1A 350mA (1A)	Code	Diameter	Watt	Lumens 3000K	Lumens 4000K	Lumens 5000K	Lumens 6500K
	C55100-SF-1A-50cm	50cm	18	3150	3330	3330	3240
	C55100-SF-1A-60cm	60cm	22	3850	4070	4070	3960
	C55100-SF-1A-70cm	70cm	28	4900	5180	5180	5040
	C55100-SF-1A-80cm	80cm	32	5600	5920	5920	5760
	C55100-SF-1A-90cm	90cm	36	6300	6660	6660	6480
	C55100-SF-1A-100cm	100cm	40	7000	7400	7400	7200
	C55100-SF-1A-110cm	110cm	44	7700	8140	8140	7920
	C55100-SF-1A-120cm	120cm	48	8400	8880	8880	8640
	C55100-SF-1A-130cm	130cm	52	9100	9620	9620	9360
	C55100-SF-1A-140cm	140cm	56	9800	10360	10360	10080
	C55100-SF-1A-150cm	150cm	64	11200	11840	11840	11520
	C55100-SF-1A-160cm	160cm	68	11900	12580	12580	12240
C55100-SF-1A-170cm	170cm	72	12600	13320	13320	12960	
C55100-SF-1A-180cm	180cm	76	13300	14060	14060	13680	

CATEGORY 1B 500mA (1B)	C55100-SF-1B-50cm	50cm	26.1	4410	4680	4680	4545
	C55100-SF-1B-60cm	60cm	31.9	5390	5720	5720	5555
	C55100-SF-1B-70cm	70cm	40.6	6860	7280	7280	7070
	C55100-SF-1B-80cm	80cm	46.4	7840	8320	8320	8080
	C55100-SF-1B-90cm	90cm	52.2	8820	9360	9360	9090
	C55100-SF-1B-100cm	100cm	58	9800	10400	10400	10100
	C55100-SF-1B-110cm	110cm	63.8	10780	11440	11440	11110
	C55100-SF-1B-120cm	120cm	69.6	11760	12480	12480	12120
	C55100-SF-1B-130cm	130cm	75.4	12740	13520	13520	13130
	C55100-SF-1B-140cm	140cm	81.2	13720	14560	14560	14140
	C55100-SF-1B-150cm	150cm	92.8	15680	16640	16640	16160
	C55100-SF-1B-160cm	160cm	98.6	16660	17680	17680	17170
	C55100-SF-1B-170cm	170cm	104.4	17640	18720	18720	18180
	C55100-SF-1B-180cm	180cm	110.2	18620	19760	19760	19190

CIRCLE SURFACE 55×100 / Lumen output tables

CATEGORY 2A 350mA (2A)	Code	Diameter	Watt	Lumens 3000K	Lumens 4000K	Lumens 5000K	Lumens 6500K
	C55100-SF-2A-50cm	50cm	36	6300	6660	6660	6480
	C55100-SF-2A-60cm	60cm	44	7700	8140	8140	7920
	C55100-SF-2A-70cm	70cm	56	9800	10360	10360	10080
	C55100-SF-2A-80cm	80cm	64	11200	11840	11840	11520
	C55100-SF-2A-90cm	90cm	72	12600	13320	13320	12960
	C55100-SF-2A-100cm	100cm	80	14000	14800	14800	14400
	C55100-SF-2A-110cm	110cm	88	15400	16280	16280	15840
	C55100-SF-2A-120cm	120cm	96	16800	17760	17760	17280
	C55100-SF-2A-130cm	130cm	104	18200	19240	19240	18720
	C55100-SF-2A-140cm	140cm	112	19600	20720	20720	20160
	C55100-SF-2A-150cm	150cm	128	22400	23680	23680	23040
	C55100-SF-2A-160cm	160cm	136	23800	25160	25160	24480
C55100-SF-2A-170cm	170cm	144	25200	26640	26640	25920	
C55100-SF-2A-180cm	180cm	152	26600	28120	28120	27360	

CATEGORY 2B 500mA (2B)	C55100-SF-2B-50cm	50cm	52.2	8820	9360	9360	9090
	C55100-SF-2B-60cm	60cm	63.8	10780	11440	11440	11110
	C55100-SF-2B-70cm	70cm	81.2	13720	14560	14560	14140
	C55100-SF-2B-80cm	80cm	92.8	15680	16640	16640	16160
	C55100-SF-2B-90cm	90cm	104.4	17640	18720	18720	18180
	C55100-SF-2B-100cm	100cm	116	19600	20800	20800	20200
	C55100-SF-2B-110cm	110cm	127.6	21560	22880	22880	22220
	C55100-SF-2B-120cm	120cm	139.2	23520	24960	24960	24240
	C55100-SF-2B-130cm	130cm	150.8	25480	27040	27040	26260
	C55100-SF-2B-140cm	140cm	162.4	27440	29120	29120	28280
	C55100-SF-2B-150cm	150cm	185.6	31360	33280	33280	32320
	C55100-SF-2B-160cm	160cm	197.2	33320	35360	35360	34340
	C55100-SF-2B-170cm	170cm	208.8	35280	37440	37440	36360
	C55100-SF-2B-180cm	180cm	220.4	37240	39520	39520	38380

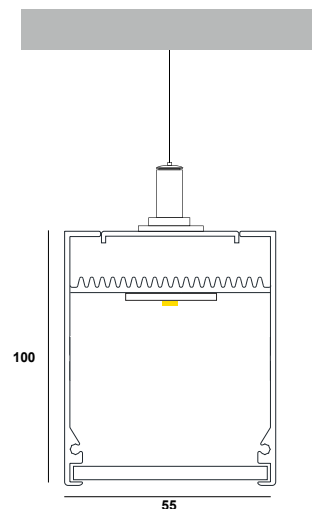

SC55100-SPD - XX - XX - XX - XX - X - XX

- (a)
Κωδικός Γραμμικού
Linear Code
- (b)
Κατηγορία
Category
- (c)
Διάμετρος
Diameter
- (d)
Θερμοκρασία
φωτός
Color
Temperature
- (e)
Χρώμα
προφίλ
Profile
color
- (f)
Αυξομείωση
έντασης φωτός
Dimming
- (g)
Τοποθέτηση
τροφοδοτικού
Power supply
placement

Παράδειγμα κωδικού / Code example

CIRCLE SUSPENDED 55×100, 1A, Ø90cm, 3000K, Black, Dimmable, Hidden Power supply
SKU: SC55100-SPD-1A-90cm-30K-BL-D-HP

Material	PCB details	CRI	Lumen output / W
Extruded aluminium	Zhaga-Compliant Dimensions	Ra>80 (Ra>90 on request)	up to 195 Lm/W

Covers	CCT	Profile color	Dimming options (D)
 Diffuser 5mm	3000K (30K)	Anodized (AN)	Push
	4000K (40K)	Black (BL)	DALI
	5000K (50K)	White (WH)	TRIAC 0/1-10V
	6500K (65K)	RAL (RL)	CASAMBI
	TUNABLE 2700K - 6500K (TN)	Graphite (GF)	Analog 0/1-10V
		Nickeling (NK)	
Patina (PT)			

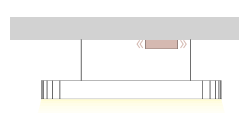
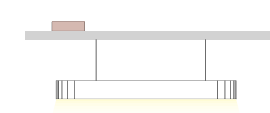
power supply installation	
<p>Μέσα σε ροζέτα Inside a rosette</p>  <ul style="list-style-type: none"> Κυκλική ροζέτα Ø400×40mm Circular rosette Ø400×40mm (RP4) Ορθογώνια ροζέτα 400×60×35mm Rectangular rosette 400×60×35mm (RP5) Ορθογώνια ροζέτα 600×80×35mm Rectangular rosette 600×80×35mm (RP6) 	<p>Κρυφό με καταπακτή πρόσβασης Hidden with access hatch</p>  <p>(HP)</p>



CIRCLES

CIRCLE SUSPENDED 55×100 / Lumen output tables

CATEGORY 1A 350mA (1A)	SKU	diameter	Wattage	Lumens 3000K	Lumens 4000K	Lumens 5000K	Lumens 6500K
	SC55100-SPD-1A-50cm	50cm	18	3150	3330	3330	3240
	SC55100-SPD-1A-60cm	60cm	22	3850	4070	4070	3960
	SC55100-SPD-1A-70cm	70cm	28	4900	5180	5180	5040
	SC55100-SPD-1A-80cm	80cm	32	5600	5920	5920	5760
	SC55100-SPD-1A-90cm	90cm	36	6300	6660	6660	6480
	SC55100-SPD-1A-100cm	100cm	40	7000	7400	7400	7200
	SC55100-SPD-1A-110cm	110cm	44	7700	8140	8140	7920
	SC55100-SPD-1A-120cm	120cm	48	8400	8880	8880	8640
	SC55100-SPD-1A-130cm	130cm	52	9100	9620	9620	9360
	SC55100-SPD-1A-140cm	140cm	56	9800	10360	10360	10080
	SC55100-SPD-1A-150cm	150cm	64	11200	11840	11840	11520
	SC55100-SPD-1A-160cm	160cm	68	11900	12580	12580	12240
SC55100-SPD-1A-170cm	170cm	72	12600	13320	13320	12960	
SC55100-SPD-1A-180cm	180cm	76	13300	14060	14060	13680	

CATEGORY 1B 500mA (1B)	SC55100-SPD-1B-50cm	50cm	26.1	4410	4680	4680	4545
	SC55100-SPD-1B-60cm	60cm	31.9	5390	5720	5720	5555
	SC55100-SPD-1B-70cm	70cm	40.6	6860	7280	7280	7070
	SC55100-SPD-1B-80cm	80cm	46.4	7840	8320	8320	8080
	SC55100-SPD-1B-90cm	90cm	52.2	8820	9360	9360	9090
	SC55100-SPD-1B-100cm	100cm	58	9800	10400	10400	10100
	SC55100-SPD-1B-110cm	110cm	63.8	10780	11440	11440	11110
	SC55100-SPD-1B-120cm	120cm	69.6	11760	12480	12480	12120
	SC55100-SPD-1B-130cm	130cm	75.4	12740	13520	13520	13130
	SC55100-SPD-1B-140cm	140cm	81.2	13720	14560	14560	14140
	SC55100-SPD-1B-150cm	150cm	92.8	15680	16640	16640	16160
	SC55100-SPD-1B-160cm	160cm	98.6	16660	17680	17680	17170
	SC55100-SPD-1B-170cm	170cm	104.4	17640	18720	18720	18180
	SC55100-SPD-1B-180cm	180cm	110.2	18620	19760	19760	19190

CIRCLE SUSPENDED 55×100 / Lumen output tables

CATEGORY 2A 350mA (2A)	SKU	diameter	Wattage	Lumens 3000K	Lumens 4000K	Lumens 5000K	Lumens 6500K
	SC55100-SPD-2A-50cm	50cm	36	6300	6660	6660	6480
	SC55100-SPD-2A-60cm	60cm	44	7700	8140	8140	7920
	SC55100-SPD-2A-70cm	70cm	56	9800	10360	10360	10080
	SC55100-SPD-2A-80cm	80cm	64	11200	11840	11840	11520
	SC55100-SPD-2A-90cm	90cm	72	12600	13320	13320	12960
	SC55100-SPD-2A-100cm	100cm	80	14000	14800	14800	14400
	SC55100-SPD-2A-110cm	110cm	88	15400	16280	16280	15840
	SC55100-SPD-2A-120cm	120cm	96	16800	17760	17760	17280
	SC55100-SPD-2A-130cm	130cm	104	18200	19240	19240	18720
	SC55100-SPD-2A-140cm	140cm	112	19600	20720	20720	20160
	SC55100-SPD-2A-150cm	150cm	128	22400	23680	23680	23040
	SC55100-SPD-2A-160cm	160cm	136	23800	25160	25160	24480
SC55100-SPD-2A-170cm	170cm	144	25200	26640	26640	25920	
SC55100-SPD-2A-180cm	180cm	152	26600	28120	28120	27360	

CATEGORY 2B 500mA (2B)	SC55100-SPD-2B-50cm	50cm	52.2	8820	9360	9360	9090
	SC55100-SPD-2B-60cm	60cm	63.8	10780	11440	11440	11110
	SC55100-SPD-2B-70cm	70cm	81.2	13720	14560	14560	14140
	SC55100-SPD-2B-80cm	80cm	92.8	15680	16640	16640	16160
	SC55100-SPD-2B-90cm	90cm	104.4	17640	18720	18720	18180
	SC55100-SPD-2B-100cm	100cm	116	19600	20800	20800	20200
	SC55100-SPD-2B-110cm	110cm	127.6	21560	22880	22880	22220
	SC55100-SPD-2B-120cm	120cm	139.2	23520	24960	24960	24240
	SC55100-SPD-2B-130cm	130cm	150.8	25480	27040	27040	26260
	SC55100-SPD-2B-140cm	140cm	162.4	27440	29120	29120	28280
	SC55100-SPD-2B-150cm	150cm	185.6	31360	33280	33280	32320
	SC55100-SPD-2B-160cm	160cm	197.2	33320	35360	35360	34340
	SC55100-SPD-2B-170cm	170cm	208.8	35280	37440	37440	36360
	SC55100-SPD-2B-180cm	180cm	220.4	37240	39520	39520	38380

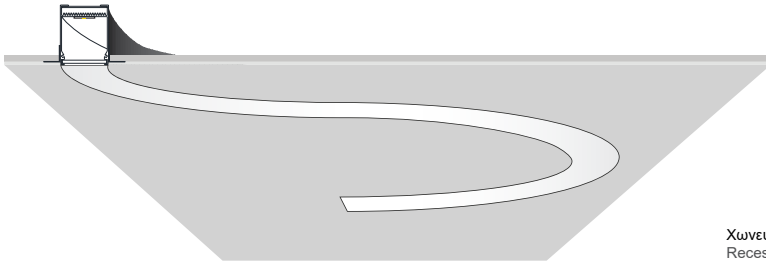

Χωνευτή τοποθέτηση
Recessed Installation

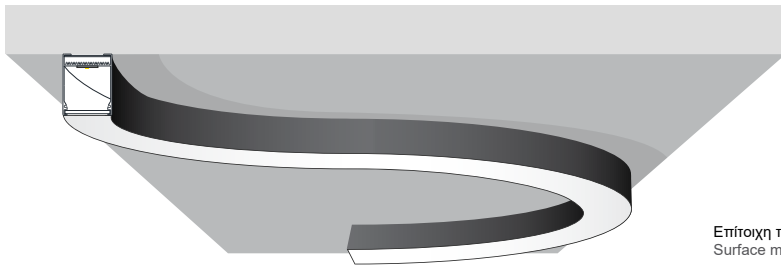
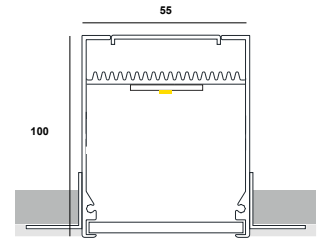

Επίτοιχη τοποθέτηση
Surface mounted installation

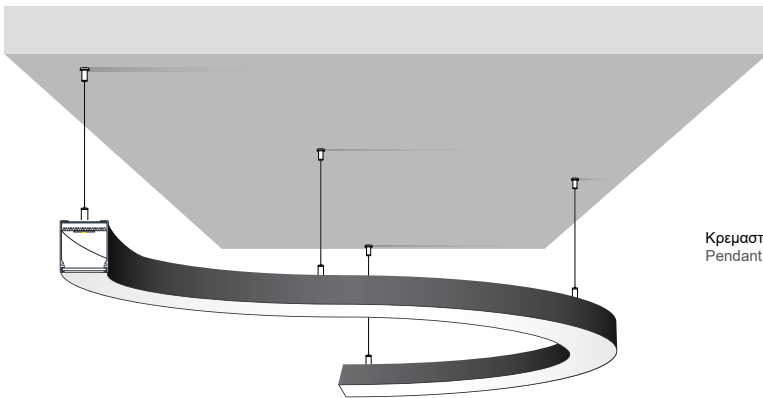
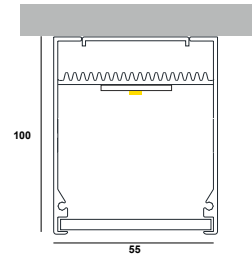

Κρεμαστή τοποθέτηση
Pendant Installation

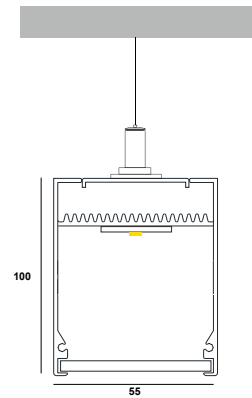

Material	PCB details	CRI	Lumen output / W
Extruded aluminium	Zhaga-Compliant Dimensions	Ra>80 (Ra>90 on request)	up to 195 Lm/W

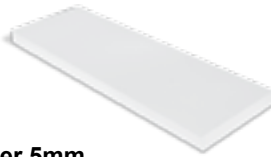
Covers	CCT	Profile color	Dimming options (D)
 <p>Diffuser 5mm</p>	3000K (30K)	Anodized (AN)	Push
	4000K (40K)	Black (BL)	DALI
	5000K (50K)	White (WH)	TRIAC 0/1-10V
	6500K (65K)	RAL (RL)	CASAMBI
	TUNABLE 2700K - 6500K (TN)	Graphite (GF)	Analog 0/1-10V
		Nickeling (NK)	
	Patina (PT)		



Linears

SPECIAL CONSTRUCTIONS

How to build your custom-made Curves

Στην **BARISLIGHT®** μπορείτε να δημιουργήσετε μοναδικά και μοντέρνα καμπύλα φωτιστικά χώρου, χωνευτά, επίτοιχα ή κρεμαστά. Επιλέξτε ανάμεσα στις διαστάσεις που παρέχουμε, προσαρμόστε τα τεχνικά χαρακτηριστικά σύμφωνα με τις ανάγκες του χώρου σας, και δημιουργήστε μοναδικά σχέδια

At **BARISLIGHT®** you can create unique and modern curved lights, recessed, wall-mounted or suspended. Choose between the dimensions we provide, adapt the technical features according to the needs of your space, and create unique designs

Ακτίνες κύκλου / Circle Radius

Το καμπύλο προφίλ μας μπορεί να καμφθεί σύμφωνα με τις παρακάτω ακτίνες.
Our curved profile can be bent according to the following radius

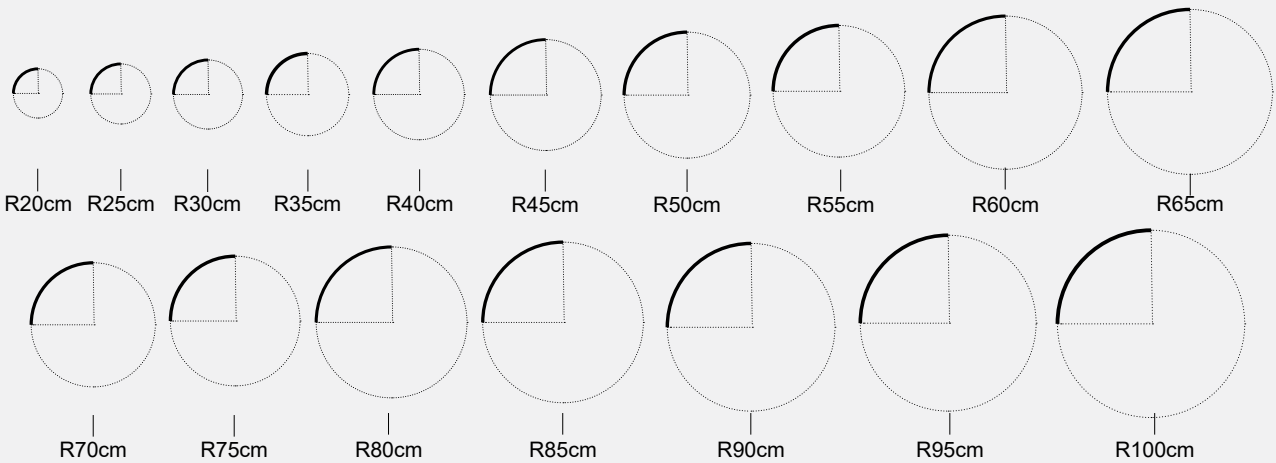

Σε συνεννόηση με την έμπειρη κατασκευαστική μας ομάδα, υπάρχουν αμέτρητες επιλογές για να δημιουργήσετε.
In consultation with our experienced construction team, there are countless options for you to create.

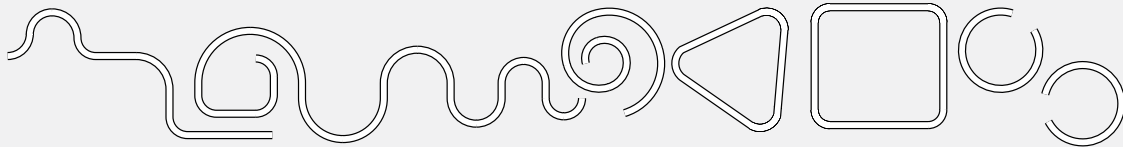

Χρώμα / Color

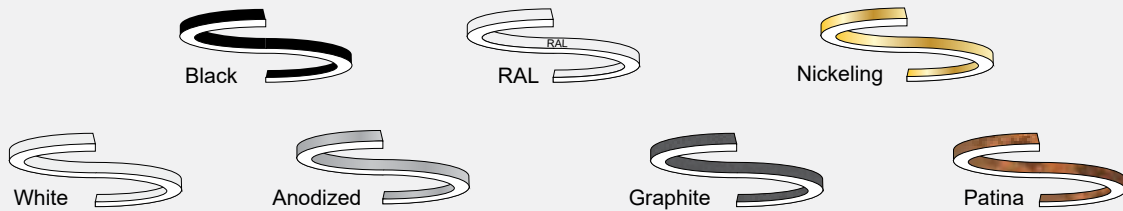

Κατηγορία απόδοσης lumen / Lumen output class

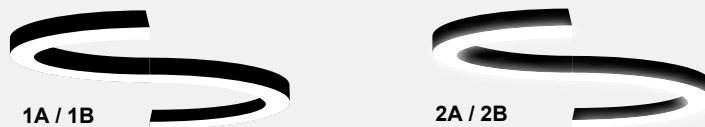

Θερμοκρασία φωτός / Color temperature





Επικοινωνώντας με την κατασκευαστική ομάδα της BarisLight, μπορείτε να δημιουργήσετε τον ιδανικό Γραμμικό φωτισμό για το χώρο σας, συνδυάζοντας τους αντιθαμβωτικούς φακούς Dark με κάλυμμα διάχυσης, δημιουργώντας εναλλαγές ανάλογα με τον φωτισμό που θέλετε να πετύχετε. Η ομάδα μας είναι έτοιμη να συζητήσει για τις ανάγκες του χώρου σας, και να σας προτείνει την ιδανική λύση.

By contacting the BarisLight manufacturing team, you can create the ideal Linear lighting for your space, combining the Dark anti-glare lenses with a diffusion cover, creating changes depending on the lighting you want to achieve. Our team is ready to discuss the needs of your space, and suggest the ideal solution.



LENA SURFACE
55x35mm
Dark / Diffuse



NILE RECESSED 55x80mm
Dark / Diffuse

Τα γραμμικά μας LENA 55x35 (χωνευτά / επίτοιχα / κρεμαστά), LINEAR 55x70 και NILE recessed 55x80 είναι σχεδιασμένα έτσι ώστε να υποδέχονται τόσο το κάλυμμα διάχυσης, όσο και τους αντιθαμβωτικούς φακούς Dark της BarisLight.

Our linear LENA 55x35 (recessed / wall mounted / pendant), LINEAR 55x70 and NILE recessed 55x80 are designed to accept both the diffusion cover and the anti-glare Dark lenses of BarisLight





Linears

SPECIAL CONSTRUCTIONS

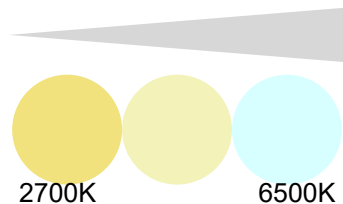

Η BarisLight® σας προσφέρει τη δυνατότητα να προσαρμόσετε το γραμμικό φωτισμό σας σύμφωνα με τις ανάγκες του χώρου σας όσο καλύτερα γίνεται. Με τα νέα μας γραμμικά Tunable 2700K - 6500K, μπορείτε να ελέγχετε απόλυτα το φωτισμό του χώρου σας και να τον προσαρμόζετε στις ανάγκες της εκάστοτε στιγμής. Επιλέγοντας 2700K, δημιουργείτε μια ζεστή ατμόσφαιρα ιδανική για χαλάρωση και φιλοξενία. Αντίθετα, επιλέγοντας 6500K, αναζωογονείτε το χώρο σας με ένα φως παρόμοιο με αυτό της ημέρας, ιδανικό για εργασία ή ανάγνωση.

BarisLight® offers you the possibility to customize your linear lighting according to the needs of your space as best as possible. With our new Linears Tunable 2700K - 6500K, you can have total control over the lighting of your space and adapt it to the needs of the moment. By choosing 2700K, you create a warm atmosphere ideal for relaxation and hospitality. On the other hand, by choosing 6500K, you brighten up your space with a light similar to daylight, ideal for working or reading.

Είτε πρόκειται για τα Dark γραμμικά μας, είτε για τα Diffuse, μπορείτε να επιλέξετε τις κατηγορίες **1A Tunable 2700K-6500K (T1)** ή **1B Tunable 2700K-6500K (T2)** και να ελέγξετε τον φωτισμό σας στο έπακρο.

Whether it's our Dark linear or Diffuse, you can choose **1A Tunable 2700K-6500K (T1)** or **1B Tunable 2700K-6500K (T2)** and control your lighting to the fullest.

1A TUNABLE 2700K-6500K 350mA (T1)	Length	Wattage	Lumens 2700K	Lumens 6500K
	60cm	11.8	1990	2070
	90cm	17.6	2985	3105
	120cm	23.5	3980	4140
	150cm	29.4	4975	5175
	180cm	35.3	5970	6210
	210cm	41.2	6965	7245
	240cm	47.0	7960	8280
	270cm	52.9	8955	9315
	300cm	58.8	9950	10350
	330cm	64.7	10945	11385
	360cm	70.6	11940	12420
	390cm	76.4	12935	13455
	420cm	82.3	13930	14490
	450cm	88.2	14925	15525
480cm	94.1	15920	16560	

- **Color dynamic from 2700K to 6500K**
- **Long service lifetime: >60000hrs**
- **Highly efficient: up to 175 Lm/W**
- **300mm cutting length**

- **PUSH BUTTON / DALI**

1B TUNABLE 2700K-6500K 500mA (T2)	Length	Wattage	Lumens 2700K	Lumens 6500K
	60cm	17.4	2790	2890
	90cm	26.0	4185	4335
	120cm	34.7	5580	5780
	150cm	43.4	6975	7225
	180cm	52.1	8370	8670
	210cm	60.8	9765	10115
	240cm	69.4	11160	11560
	270cm	78.1	12555	13005
	300cm	86.8	13950	14450
	330cm	95.5	15345	15895
	360cm	104.2	16740	17340
	390cm	112.8	18135	18785
	420cm	121.5	19530	20230
	450cm	130.2	20925	21675
480cm	138.9	22320	23120	

6500K

4000K

2700K



Το Blu2Light είναι ένα ασύρματο σύστημα διαχείρισης φωτισμού που βασίζεται στην τεχνολογία Bluetooth®. Επιτρέπει τον βολικό, απλό και ασύρματο έλεγχο του φωτισμού μέσω εφαρμογών με χρήση κινητών συσκευών.

Με αυτόν τον τρόπο, μπορούν να συνδεθούν DALI, DMX, τροφοδοτικά LED, σένσορες και γενικά έλεγχος χώρου. Το σύστημα αυτό, μπορεί να χρησιμοποιηθεί για ένα ευρύ φάσμα εφαρμογών.

Blu2Light

Blu2Light is a wireless lighting management system based on Bluetooth® technology. It allows convenient, simple and wireless control of lighting through applications using mobile devices.

In this way, DALI, DMX, LED power supplies, sockets and general room control can be connected. This system can be used for a wide range of applications

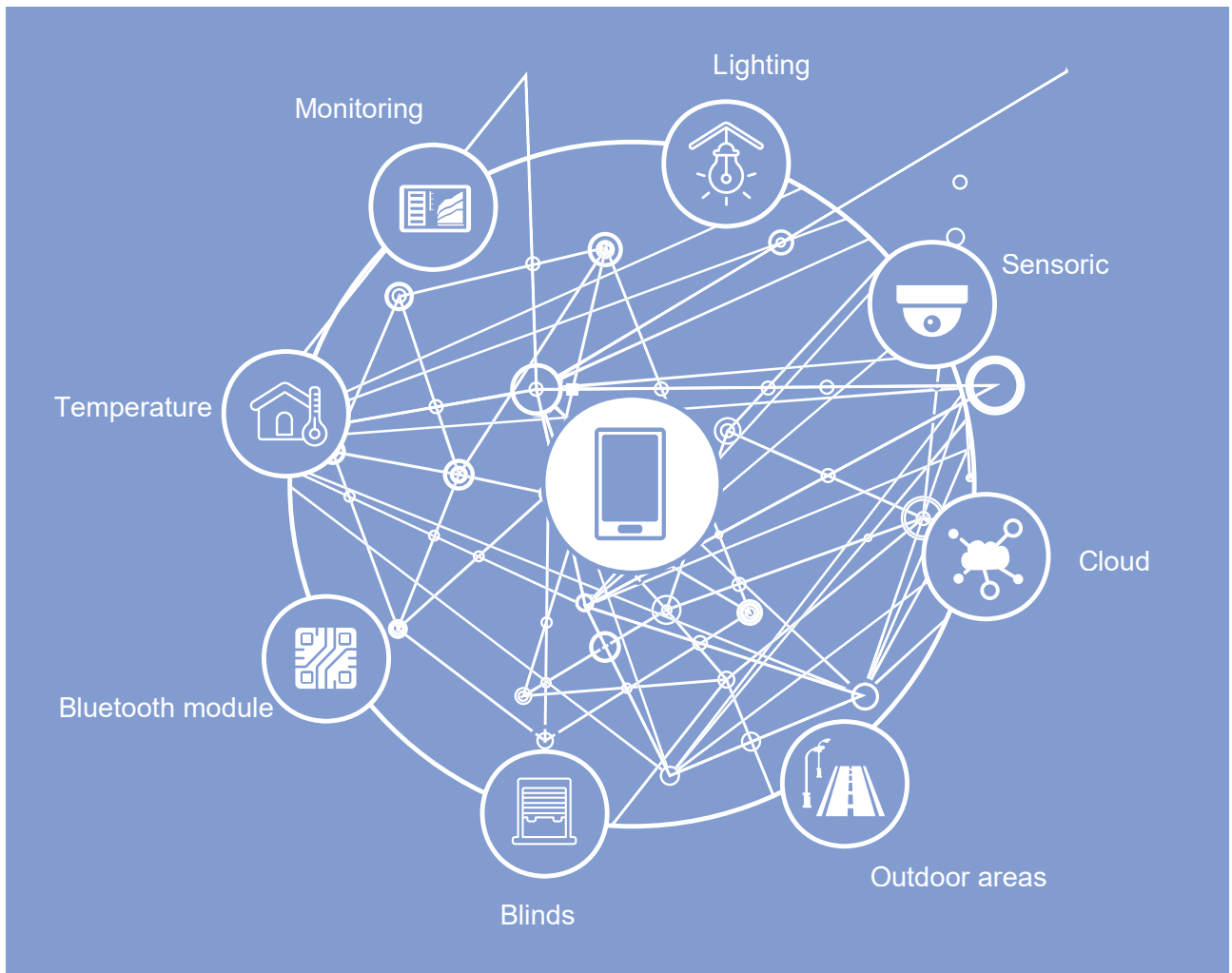



BARISLIGHT

Όροι εγγύησης

Σε περίπτωση που μια συσκευή παρουσιάσει εντός του συμφωνημένου χρόνου ισχύος της εργοστασιακής εγγύησης της "BARIS LIGHT" σφάλμα υλικού ή κατασκευαστικό ελάττωμα, η συσκευή ή το ελαττωματικό εξάρτημα επισκευάζεται ή αντικαθίσταται από την "BARIS LIGHT" σύμφωνα με την κρίση της. Η "BARIS LIGHT" αναλαμβάνει την πλήρη ή μερική αντικατάσταση των απαραίτητων ανταλλακτικών για την επαναφορά της απρόσκοπτης λειτουργίας. Η "BARIS LIGHT" έχει δικαίωμα να χρησιμοποιεί μεταχειρισμένα, ανακατασκευασμένα ανταλλακτικά. Το εργατικό κόστος ή όποιο άλλο κόστος τρίτου δεν είναι υποχρέωση της "BARIS LIGHT". Η δυσαναλογία κατά την προαναφερόμενη έννοια συνίσταται ιδίως στην περίπτωση που οι απαιτούμενες ενέργειες θα συνεπάγονταν για την "BARIS LIGHT" έξοδα πέραν του ορίου του ανεκτού:

σε σχέση με την τιμή αγοράς ή/και την αξία της συσκευής σε κατάσταση χωρίς ελαττώματα, λαμβάνοντας υπόψη τη σοβαρότητα του ελαττώματος και κατ'εκτίμηση, εάν θα μπορούσαν να εφαρμοστούν εναλλακτικοί τρόποι αποκατάστασης του ελαττώματος χωρίς σημαντικές δυσχέρειες για τον αγοραστή. Επαφίεται ωστόσο στην κρίση της "BARIS LIGHT", να ζητήσει την αποστολή του ελαττωματικού εξαρτήματος για επισκευή ή αντικατάσταση. Η "BARIS LIGHT" έχει μόνο υποχρέωση για αφαίρεση ή τοποθέτηση του εξαρτήματος, εφόσον απαιτούνται ειδικές γνώσεις, τις οποίες δεν κατέχει ή δεν αναμένεται να κατέχει ο αγοραστής, διαφορετικά η υποχρέωση της "BARIS LIGHT" σε σχέση με το ελάττωμα εξαντλείται με την παράδοση του επισκευασμένου ή αντικατεστημένου εξαρτήματος στον αγοραστή.

Στην εργοστασιακή εγγύηση δεν περιλαμβάνονται επιπρόσθετα και τα έξοδα αποστολής, καθώς και ενδεχομένως τα έξοδα μετάβασης και παραμονής του προσωπικού συντήρησης της "BARIS LIGHT" για επιτόπιες επισκευές, κατά την εγκατάσταση συσκευών εντός της Ελλάδας καθώς επίσης και στις παρακάτω χώρες: Αυστρία, Βέλγιο, Βουλγαρία, Γαλλία, Γερμανία, Δημοκρατία της Τσεχίας, Ελβετία, Ελλάδα, Κύπρος, Ηνωμένα Αραβικά Εμιράτα, Ιαπωνία, Ινδία, Ισπανία, Ισραήλ, Ιταλία, Λουξεμβούργο, Μεγάλη Βρετανία, Νότιος Αφρική, Νότιος Κορέα, Ολλανδία, Πορτογαλία, Ταϊλάνδη, Χιλή. Αποκλείονται τελωνειακοί δασμοί, φόροι και λοιπά έξοδα εισαγωγής. Για τη Βόρεια Αμερική ισχύουν ξεχωριστοί όροι εγγύησης.

Αναλώσιμα και εξαρτήματα, που υπόκεινται σε φυσιολογική φθορά, δεν καλύπτονται από την παρούσα εγγύηση (π.χ. Μετασχηματιστές, τροφοδοτικά, πυκνωτές, ασφάλειες, φίλτρα, διατάξεις προστασίας από υπερφόρτιση).

Έκταση της εργοστασιακής εγγύησης
Προϋπόθεση για την εκτέλεση παροχών εγγύησης χωρίς χρέωση είναι:

Ο αγοραστής οφείλει να γνωστοποιήσει άμεσα στην "BARIS LIGHT" τις διαπιστωμένες ελλείψεις, με μήνυμα με σύντομη περιγραφή του σφάλματος στη γραμμή εξυπηρέτησης "BARIS LIGHT".

Υποβολή ενός αντιγράφου του παραστατικού αγοράς

Η πινακίδα τύπου της συσκευής πρέπει να είναι απόλυτα ευανάγνωστη.

Συνεννόηση για τη διαδικασία με την "BARIS LIGHT" ή τους συνεργάτες σέρβις αυτής.

Για τη διενέργεια των σύμφωνα με την εκτίμηση της "BARIS LIGHT" απαραίτητων επισκευών και παραδόσεων αντικατάστασης, ο πελάτης οφείλει να παράσχει στην "BARIS LIGHT" τον απαιτούμενο χρόνο και την απαιτούμενη ευκαιρία. Τα παλιά, ελαττωματικά εξαρτήματα περιέρχονται στην ιδιοκτησία της "BARIS LIGHT". Η εργοστασιακή εγγύηση δεν καλύπτει ζημιές, που οφείλονται σε:

ζημιές κατά τη μεταφορά

λανθασμένη εγκατάσταση ή θέση σε λειτουργία από τον αγοραστή ή από τρίτους
επεμβάσεις, τροποποιήσεις ή προσπάθειες επισκευής από τον αγοραστή ή από τρίτους
παράβλεψη των οδηγιών χρήσης, των προδιαγραφών συντήρησης
ακατάλληλη χρήση ή αδόκιμη λειτουργία

ανεπαρκή αερισμό της συσκευής (αν κρίνεται απαραίτητο από τις οδηγίες εγκατάστασης του προϊόντος)

ατυχήματα, εξωτερική επίδραση

ανωτέρα βία (π.χ. πτώση κεραυνού, υπέρταση, κακοκαιρία, πυρκαγιά)

Επίσης, δεν καλύπτει ελαττώματα αισθητικού χαρακτήρα ή σημάδια φθοράς, τα οποία δεν επηρεάζουν την τροφοδοσία ενέργειας. Εάν ο αγοραστής απαιτήσει με αυτή την εγγύηση μη απαραίτητες ή αναίτιες επεμβάσεις του σέρβις, η "BARIS LIGHT" έχει δικαίωμα να τον χρεώσει με τα έξοδα που θα προκύψουν. Το ίδιο ισχύει για χρόνους αναμονής, εάν ο αγοραστής δεν παράσχει στο προσωπικό συντήρησης άμεση πρόσβαση στην ελαττωματική συσκευή. Εφόσον δεν προβλέπεται ρητά από το νόμο ευθύνη της "BARIS LIGHT", η εργοστασιακή εγγύηση δεν περιλαμβάνει υποχρεώσεις πέραν των αναφερόμενων στους όρους της εγγύησης, ιδίως δε σε ότι αφορά την κάλυψη ζημιών που προέκυψαν άμεσα ή έμμεσα.

Terms of Warranty

In the event that a device presents a material or manufacturing defect within the agreed warranty period of "BARIS LIGHT", the appliance or defective component is repaired or replaced by "BARIS LIGHT" at its discretion. "BARIS LIGHT" undertakes the replacement or replacement of the spare parts necessary to restore uninterrupted operation. "BARIS LIGHT" has the right to use used, remanufactured spare parts. The labor costs or any other cost of a third party is not an obligation of "BARIS LIGHT". The imbalance in the above-mentioned concept consists in particular in the event that the required actions would entail costs beyond the tolerable limit for "BARIS LIGHT":

in relation to the purchase price and / or the value of the appliance in a non-defective condition, taking into account the seriousness of the defect and, if so, whether alternative ways of remedying the defect could be applied without significant difficulties for the purchaser.

However, it is up to BARIS LIGHT to ask for the defective part to be repaired or replaced. "BARIS LIGHT" has only the obligation to remove or place the accessory if special knowledge is required which the purchaser does not own or are not expected to own, otherwise the obligation of "BARIS LIGHT" in relation to the defect is depleted by delivering the repaired or replaced component to the buyer.

The factory warranty does not include additionally shipping costs and, where applicable, the cost of travel and subsistence of BARIS LIGHT maintenance personnel for on-site repairs when installing appliances within Greece as well as in the following countries: Austria, Belgium, Bulgaria, France, Germany, Czech Republic, Switzerland, Greece, Cyprus, United Arab Emirates, Japan, India, Spain, Israel, Italy, Luxemburg, Great Britain, South Africa, South Korea, Netherlands, Portugal, Thailand, Chile or. Customs duties, taxes and other import charges are excluded. For North America, separate warranty terms apply.

Consumables and accessories subject to normal wear and tear are not covered by this warranty (eg Transformers, power supplies, capacitors, fuses, filters, overload protection devices).

Scope of the factory warranty

The condition for the performance of free-of-charge warranty services is:

The buyer must immediately notify BARIS LIGHT of the deficiencies found, with a short description of the error in the service bar "BARIS LIGHT".

Submission of a copy of the purchase receipt

The type plate of the device must be perfectly legible.

Consultation on the procedure with "BARIS LIGHT" or its service partners.

In order to carry out the necessary repairs and replacement deliveries according to the "BARIS LIGHT" estimate, the customer must provide "BARIS LIGHT" with the required time and the required opportunity. The old, defective parts come to the property of "BARIS LIGHT". The factory warranty does not cover damages due to:

damage during transport

incorrect installation or commissioning by the buyer or by third parties

interventions, modifications, or repair efforts by the buyer or by third parties

ignoring instructions for use, maintenance specifications

inappropriate use or inadequate operation

insufficient ventilation of the appliance (if necessary as per the installation instructions for the product)

accidents, external impact

Force majeure (eg lightning strike, hypertension, bad weather, fire)

It also does not cover aesthetic defects or signs of wear, which do not affect the supply energy. If the buyer demands with this guarantee unnecessary or unnecessary service interventions, BARIS LIGHT is entitled to charge it with the costs incurred. The same applies for waiting times if the buyer does not provide maintenance personnel with direct access to the faulty device. As long as the liability of BARIS LIGHT is not expressly provided for by law, the factory warranty does not include obligations other than those specified in the terms of the guarantee, in particular as regards the coverage of losses incurred directly or indirectly.



Το προϊόν έχει ελεγχθεί και θεωρείται ότι πληροί τις ευρωπαϊκές προδιαγραφές ως προς την ασφάλεια και την προστασία της υγείας και του περιβάλλοντος.
The product has been tested and is considered to meet European standards for safety, health and environmental protection.



Περιορισμός επικίνδυνων ουσιών: Το προϊόν συμμορφώνεται με την οδηγία RoHS και κάθε ομοιογενές υλικό δεν υπερβαίνει τα όρια για τα υλικά που αναφέρονται στην οδηγία RoHS (Pb, Hg, Cd, Cr6+, PBB και PBDE)
Restriction of Hazardous Substances (RoHS): PRODUCT COMPLIES WITH rOhs directive and each homogenous material does not exceed the limits for materials mentioned under the RoHS directive (Pb,Hg,Cd, Cr6+, PBB and PBDE)



Το προϊόν διαθέτει εγγύηση χρόνων ίση με την αναγραφόμενη τιμή
The product is guaranteed for a period of time equal to the number indicated.



Τύπος προστασίας: Μονός
Safety class: One



Τύπος προστασίας: Διπλός
Safety class: Two



Τύπος προστασίας: Τριπλός
Safety class: Three



Η διάρκεια ζωής του προϊόντος ισούται με τον αριθμό ωρών που αναγράφονται.
The lifetime of the product is equal to the number of hours indicated.



Προστασία από εισχώρηση σωμάτων Ø2.5mm
Protection from ingress of Ø2.5mm elements



Προστασία από εισχώρηση σωμάτων Ø1mm
Protection from ingress of Ø1mm elements



Προστασία από δυσλειτουργίες λόγω σκόνης και έκθεσης του υλικού στο νερό
Protection from malfunctions due to dust and water



Πλήρης προστασία από σκόνη και έκθεσης του υλικού στο νερό
Full protection from dust and exposure to water



Πλήρης προστασία από σκόνη και έκθεσης του υλικού στο νερό υψηλής πίεσης (Jet 12,5 l / min σε απόσταση 2,5 μέτρων από οποιαδήποτε κατεύθυνση)
Full protection from dust and high pressure water (Jet of 12.5 l/min at a distance of 2.5 metres from any direction)



Πλήρης προστασία από σκόνη και έκθεσης του υλικού στο νερό υψηλής πίεσης (Jet 100l / min σε απόσταση 2,5 μέτρων από οποιαδήποτε κατεύθυνση)
Full protection from dust and high pressure water (Powerful jets of 100 l/min at a distance of 2.5 metres from any direction)



Πλήρης προστασία από σκόνη και από ασυνεχή βύθιση στο νερό
Full protection from dust and intermittent submersion in water



Πλήρης προστασία από σκόνη και από συνεχή βύθιση σε νερό σταθερής πίεσης
Full protection from dust and against constant immersion in water under certain pressure



Το προϊόν προστατεύεται από πρόσκρουση 1 joule
Product is protected against 1 joule of impact



Το προϊόν προστατεύεται από πρόσκρουση 2 joules
Product is protected against 2 joules of impact



Το προϊόν προστατεύεται από πρόσκρουση 5 joules
Product is protected against 5 joules of impact



Το προϊόν προστατεύεται από πρόσκρουση 10 joules
Product is protected against 10 joules of impact



Το προϊόν προστατεύεται από πρόσκρουση 20 joules
Product is protected against 20 joules of impact



Το προϊόν είναι ανθεκτικό στην υπεριώδη ακτινοβολία (UV) ή στο ηλιακό φως. Τα προϊόντα που δεν αντέχουν στην υπεριώδη ακτινοβολία μπορούν να υποβαθμιστούν ή να αποχρωματιστούν γρήγορα όταν εκτίθενται σε ακτινοβολία UV
Product is resistant against ultraviolet (UV) light or sunlight. Non-UV resistant products can degrade or discolor fast when exposed UV light.



Το προϊόν έχει δοκιμαστεί για εφαρμογές walkover
The product has been tested for walkover applications



Διαστάσεις τετράγωνης οπής (σε mm)
Dimensions of square fitting opening (mm)



Διαστάσεις στρογγυλής οπής (σε mm)
Dimensions of round fitting opening (mm)



Το προϊόν προορίζεται για εσωτερικό χώρο
The product is intended for indoor use



Το προϊόν προορίζεται για εξωτερικό χώρο
The product is intended for outdoor use



Το προϊόν προορίζεται για εσωτερικό και εξωτερικό χώρο
The product is intended for both indoor and outdoor use



Το προϊόν προορίζεται για υποβρύχια τοποθέτηση
The product is intended for underwater application



Επιφάνεια τοποθέτησης προϊόντος: Οροφή
Product's installation surface: Ceiling



Επιφάνεια τοποθέτησης προϊόντος: Έδαφος
Product's installation surface: Ground



Επιφάνεια τοποθέτησης προϊόντος: Τοίχος
Product's installation surface: Wall



Σταθερή τάση 12/24 volt
Constant Voltage 12/24 Volt



Σταθερή τάση 230VAC
Constant Voltage 230VAC



Το προϊόν διαθέτει την δυνατότητα αυξομειώσης της φωτεινότητας
The product is dimmable.



Η γωνία δέσμης του προϊόντος ισούται με την αναγραφόμενη τιμή
The beam angle of the product is equal to the indicated value



Το προϊόν εκπέμπει διάχυτο φως.
The product emits diffuse light.



Η γωνία δέσμης του προϊόντος είναι 360°
The beam angle of the product is 360°



Το προϊόν διαθέτει δυνατότητα περιστροφής ως προς τον οριζόντιο άξονα
The product can be rotated on the horizontal axis



Το προϊόν διαθέτει δυνατότητα περιστροφής ως προς τον κάθετο άξονα
The product can be rotated on the vertical axis



Το προϊόν διαθέτει δυνατότητα περιστροφής ως προς τον οριζόντιο και κάθετο άξονα
The product can be rotated on both horizontal and vertical axis



Ο φακός του Downlight μπορεί να περιστραφεί σύμφωνα με τις αναγραφόμενες μοίρες
The lens of the Downlight can be rotated according to the indicated degrees



Το προϊόν υποδέχεται λαμπτήρα τύπου GU10
The product accepts GU10 type bulb



Η κάμψη της λωρίδας LED είναι δυνατή με ακτίνα $\geq x$ χιλιοστόμετρα στην καθορισμένη κατεύθυνση
Bending of the Led strip is possible with a radius of $\geq x$ millimetres in the specified direction



Η ταινία LED διατίθεται σε καρούλι με μήκος όσο η αναγραφόμενη τιμή
The LED strip is available on a reel with a length equal to the indicated price



Η απόδοση Lumen / W του προϊόντος ισούται με την αναγραφόμενη τιμή
The Lumen/W output of the product is equal to the indicated value



Η τιμή CRI του προϊόντος ισούται με την αναγραφόμενη τιμή
The CRI rate of the product is equal to the indicated value



Θερμό Λευκό
Warm White



Φυσικό Λευκό
Natural White



Ψυχρό Λευκό
Cold White



Ρυθμιζόμενη θερμοκρασία φωτός από Θερμό Λευκό σε Ψυχρό Λευκό
Tunable light temperature from Warm White to Cool White



Κόκκινο
Red



Πράσινο
Green



Μπλε
Blue



Πορτοκαλί
Amber



RGB



RGBWW



RGBCW

Αποποίηση ευθύνης:

Παρά την προσπάθειά μας να διασφαλίσουμε την ακρίβεια των πληροφοριών στον κατάλογο αυτό, ενδέχεται να υπάρχουν σφάλματα ή παραλείψεις. Η BarisLight διατηρεί το δικαίωμα να τροποποιήσει τις προδιαγραφές των προϊόντων, τις τιμές και τη διαθεσιμότητα χωρίς προηγούμενη ειδοποίηση. Η BarisLight δεν φέρει καμία ευθύνη για τυχόν διαφορές ή προβλήματα που ενδέχεται να προκύψουν λόγω τυπογραφικών λαθών ή αλλαγών στις παρεχόμενες πληροφορίες. Συνιστούμε την επιβεβαίωση των λεπτομερειών των προϊόντων με την ομάδα πωλήσεών μας πριν από οποιαδήποτε απόφαση αγοράς.

Disclaimer:

While every effort has been made to ensure the accuracy of the information in this catalog, errors and omissions may occur. BarisLight reserves the right to make changes to product specifications, pricing, and availability without prior notice. BarisLight takes no responsibility for any discrepancies or issues that may arise due to typographical errors or changes to the information provided. We recommend verifying product details with our sales team before making any purchasing decisions.



barislight.eu



b2b.barislight.eu



Έκθεση:
Ελ. Βενιζέλου και Βύρωνος,
26333 Πάτρα

Βιοτεχνία:
Γλαύκου 83, 26332 Πάτρα



2610 317 313
2610 317 300



info@barislight.eu



barislight.eu
b2b.barislight.eu



Baris Light