

JAZ DUO SUSPENDED HORIZONTAL BASE A

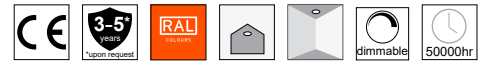

ΠΕΡΙΕΧΟΜΕΝΑ / CONTENTS

DATASHEET 1
 MANUAL 4

SKU: J30DHA - XX-XX-XX-XX-XX

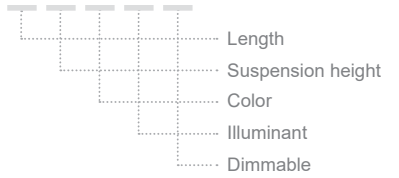

DATASHEET

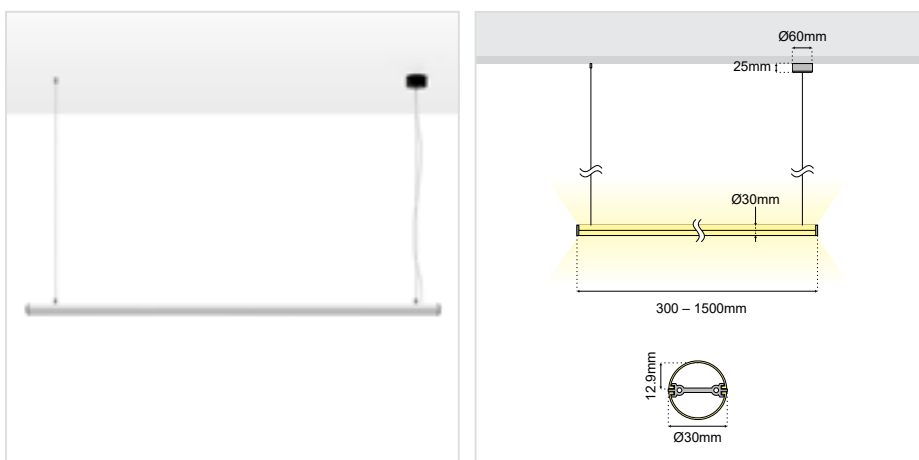





GENERAL INFORMATION













APPLICATION	Indoor / Suspended
DIRECTION OF MOUNTING	Ceiling
MATERIAL	Aluminium
PROFILE DIMENSIONS (Ø)	30mm
BASE DIMENSIONS (Ø×H)	60×25mm
LIFE TIME	50000 hours
WARRANTY	3-5 years (*5 years upon request)
ORIGIN	Greece

JAZ DUO SUSPENDED HORIZONTAL BASE A DATASHEET

SKU: J30DHA-XX-XX-XX-XX-XX

LENGTH
SUSPENSION HEIGHT
COLOR
ILLUMINANT
DIMMABLE

Length*			Suspension height*				Color	
30cm (30)	40cm (40)	50cm (50)	10cm (10)	20cm (20)	30cm (30)	40cm (40)	Anodised (AN)	
60cm (60)	70cm (70)	80cm (80)	50cm (70)	60cm (60)	70cm (70)	80cm (80)	Black (BL)	
90cm (90)	100cm (100)	110cm (110)	90cm (90)	100cm (100)	110cm (110)	120cm (120)	White (WH)	
120cm (120)	130cm (130)	140cm (140)	130cm (130)	140cm (140)	150cm (150)	160cm (160)	Graphite (GF)	
150cm (150)			170cm (170)	180cm (180)	190cm (190)	200cm (200)	RAL colors (RL)	
							Patina (PT)	









Illuminant*						
Wattage	Voltage	CCT	CRI	Output	CODE*	
12W/m	24V	2700K	Ra>90	972 lm/m	(6X279)	
		3000K		1080 lm/m	(6X239)	
		4000K		1200 lm/m	(6X249)	
		6000K		1260 lm/m	(6X269)	
19.2W/m	24V	3000K	Ra>80	1080 lm/m	(9.6X238)	
		4000K		1200 lm/m	(9.6X248)	
		6000K		1260 lm/m	(9.6X268)	
19.2W/m	12V	Red		1730~2000 lm/m	(9.6X212R)	
		Green		1730~2000 lm/m	(9.6X212G)	
		Amber		1730~2000 lm/m	(9.6X212A)	
	24V	Red		1730~2000 lm/m	(9.6X224R)	
		Green		1730~2000 lm/m	(9.6X224G)	
		Amber		1730~2000 lm/m	(9.6X224A)	

Continued on next page →

JAZ DUO SUSPENDED HORIZONTAL BASE A DATASHEET

SKU: J30DHA- XX-XX-XX-XX-XX

LENGTH
SUSPENSION HEIGHT
COLOR
ILLUMINANT
DIMMABLE

Illuminant (cont.)*						
Wattage	Voltage	CCT		CRI	Output	CODE*
24W/m	24V	2700K		Ra>90	1920 lm/m	(12X279)
		3000K			2160 lm/m	(12X239)
		4000K			2400 lm/m	(12X249)
		6000K			2640 lm/m	(12X269)
		RGB+3000K			2040 lm/m	(12X2R39)
		RGB+6000K			2040 lm/m	(12X2R69)
	230V	3000K		Ra>80	2000 lm/m	(12X23V38)
		4000K			2000 lm/m	(12X23V48)
		6500K			2000 lm/m	(12X23V658)

Dimmable*
Dim (D)
No dim ()

Please get the corresponding **Controllers / Dimmers** from our wide range of products.

* Υποχρεωτική επιλογή / Mandatory option

Δημιουργία Κωδικού προϊόντος / Product Code generator

J30DHA- length - suspension height - color - illuminant - dimmable

EXAMPLE:

J30DHA - 90-120-BL-1239-D

for JAZ DUO SUSPENDED HORIZONTAL BASE A, 90cm length, 120cm suspension height, black, 12W/m, 24VDC, 3000K, Ra90, dimmable

JAZ DUO SUSPENDED HORIZONTAL BASE A MANUAL

ΟΔΗΓΙΕΣ ΕΓΚΑΤΑΣΤΑΣΗΣ INSTALLATION INSTRUCTIONS

ΣΗΜΑΝΤΙΚΟ:

Αυτό το εξάρτημα πρέπει να εγκατασταθεί από εξειδικευμένο ηλεκτρολόγο.

Η BarisLight δεν φέρει ευθύνη για τυχόν ζητήματα που προκύπτουν από ακατάλληλη εγκατάσταση που δεν συμμορφώνεται με τα τοπικά πρότυπα ασφαλείας.

Παρακαλούμε δώστε ένα αντίγραφο αυτών των οδηγιών στο άτομο που είναι υπεύθυνο για τη συντήρηση της εγκατάστασης.

IMPORTANT:

This luminaire must be installed by a qualified electrician.

Disclaimer:

BarisLight is not liable for any issues arising from improper installation that does not comply with local safety standards.

Instructions:

Please provide a copy of these instructions to the person responsible for maintaining the installation.

ΤΟΠΟΘΕΤΗΣΗ ΒΑΣΗΣ ΣΤΗΝ ΟΡΟΦΗ MOUNTING THE BASE TO THE CEILING

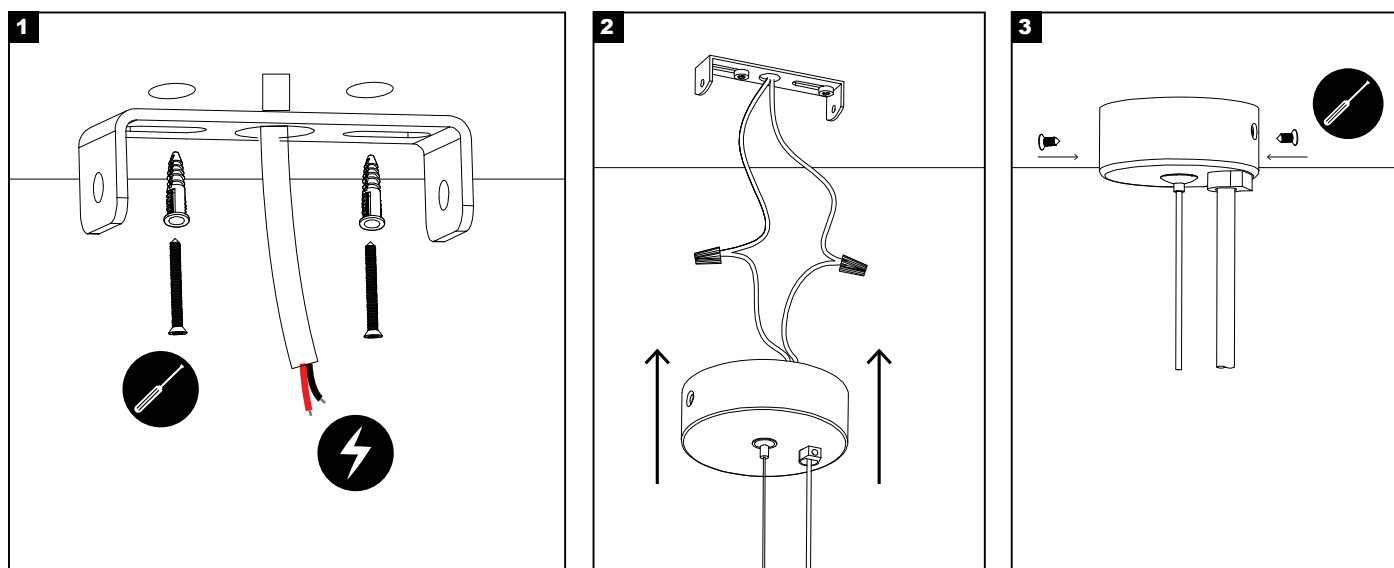

ΔΙΑΔΙΚΑΣΙΑ ΚΑΛΩΔΙΩΣΗΣ WIRING PROCEDURE

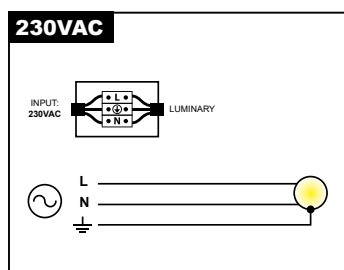

1. Κλείστε τον κεντρικό διακόπτη ρεύματος.
2. Συνδέστε τα φωτιστικά στη μονάδα παροχής ρεύματος.
3. Συνδέστε τη μονάδα τροφοδοσίας στο ηλεκτρικό δίκτυο.
4. Ενεργοποιήστε τον κεντρικό διακόπτη ρεύματος.

1. Turn off the main power switch.
2. Connect the luminaires to the power supply unit.
3. Connect the power supply unit to the electrical network.
4. Turn on the main power switch.

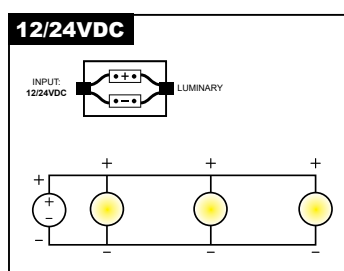

Σημείωση ασφαλείας: Βεβαιωθείτε ότι ο κεντρικός διακόπτης λειτουργίας είναι απενεργοποιημένος κατά τη διάρκεια όλων των διαδικασιών συντήρησης και εγκατάστασης.

Προειδοποίηση: Αποφύγετε τη σύνδεση πάρα πολλών φωτιστικών παράλληλα σε μία μόνο μονάδα τροφοδοσίας για να αποφευχθεί η υπερφόρτωση.

Safety Notice: Ensure the main power switch is turned off during all maintenance and installation procedures.

Warning: Avoid connecting too many luminaires in parallel to a single power supply unit to prevent overloading.

JAZ DUO SUSPENDED HORIZONTAL BASE A MANUAL

ΤΟΠΟΘΕΤΗΣΗ ΣΤΗΝ ΟΡΟΦΗ MOUNTING TO THE CEILING

