

JAZ SUSPENDED HORIZONTAL BASE A

ΠΕΡΙΕΧΟΜΕΝΑ / CONTENTS

DATASHEET 1
 MANUAL 4

SKU: J30HA - XX-XX-XX-XX-XX

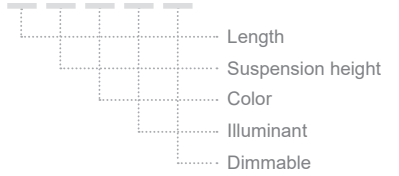

DATASHEET

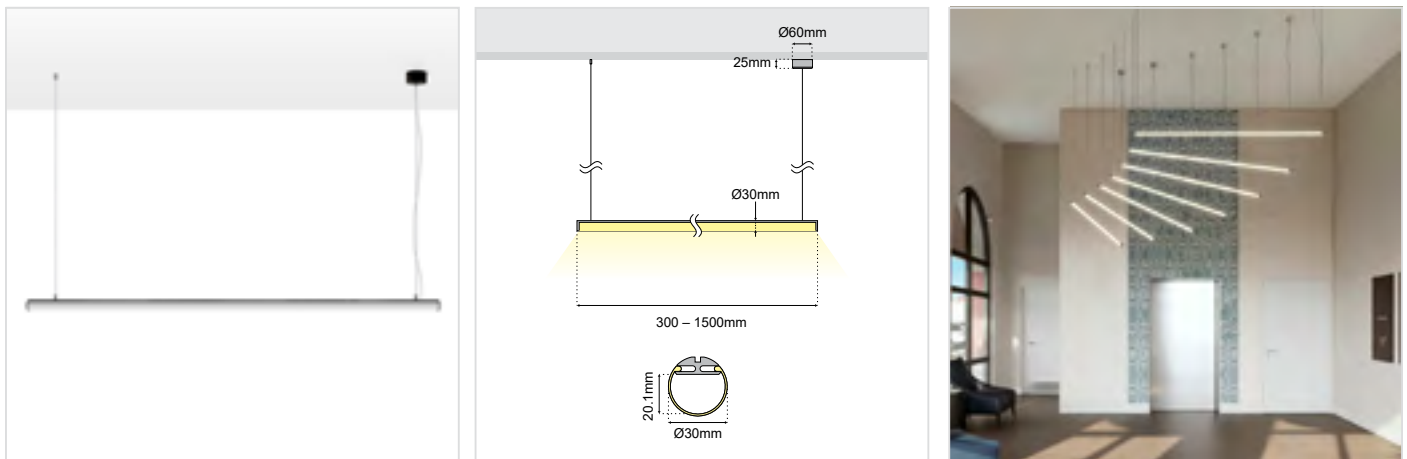





GENERAL INFORMATION

APPLICATION	Indoor / Suspended
DIRECTION OF MOUNTING	Ceiling
MATERIAL	Aluminium
PROFILE DIMENSIONS (Ø)	30mm
BASE DIMENSIONS (Ø×H)	60×25mm
LIFE TIME	50000 hours
WARRANTY	3-5 years (*5 years upon request)
ORIGIN	Greece

JAZ SUSPENDED HORIZONTAL BASE A DATASHEET

SKU: J30HA - XX-XX-XX-XX-XX

LENGTH
SUSPENSION HEIGHT
COLOR
ILLUMINANT
DIMMABLE

Length*			Suspension height*				Color	
30cm (30)	40cm (40)	50cm (50)	10cm (10)	20cm (20)	30cm (30)	40cm (40)	Anodised (AN)	
60cm (60)	70cm (70)	80cm (80)	50cm (70)	60cm (60)	70cm (70)	80cm (80)	Black (BL)	
90cm (90)	100cm (100)	110cm (110)	90cm (90)	100cm (100)	110cm (110)	120cm (120)	White (WH)	
120cm (120)	130cm (130)	140cm (140)	130cm (130)	140cm (140)	150cm (150)	160cm (160)	Graphite (GF)	
150cm (150)			170cm (170)	180cm (180)	190cm (190)	200cm (200)	RAL colors (RL)	
							Patina (PT)	

















Illuminant*								
Wattage	Voltage	CCT	CRI	Output	CODE*			
6W/m	24V	2700K	Ra>90	486 lm/m	(679)			
		3000K		540 lm/m	(639)			
		4000K		600 lm/m	(649)			
		6000K		630 lm/m	(669)			
9.6W/m	24V	3000K	Ra>80	540lm/m	(9.638)			
		4000K		600 lm/m	(9.648)			
		6000K		630 lm/m	(9.668)			
	12V	12V	Red		865~1000 lm	(9.612R)		
			Green		865~1000 lm	(9.612G)		
			Amber		865~1000 lm	(9.612A)		
		24V	24V	Red		865~1000 lm	(9.624R)	
				Green		865~1000 lm	(9.624G)	
				Amber		865~1000 lm	(9.624A)	

Continued on next page →

JAZ SUSPENDED HORIZONTAL BASE A DATASHEET

SKU: J30HA - XX-XX-XX-XX-XX

LENGTH
SUSPENSION HEIGHT
COLOR
ILLUMINANT
DIMMABLE

Illuminant (cont.)*						
Wattage	Voltage	CCT		CRI	Output	CODE*
12W/m	24V	2700K		Ra>90	960 Lm/m	(1279)
		3000K			1080 Lm/m	(1239)
		4000K			1200 Lm/m	(1249)
		6000K			1320 Lm/m	(1269)
		RGB+3000K			1020 Lm/m	(12R39)
		RGB+6000K			1020 Lm/m	(12R69)
	230V	3000K		Ra>80	1000 lm/m	(123V38)
		4000K			1000 lm/m	(123V48)
		6500K			1000 lm/m	(123V658)
	16W/m	24V	RGB			
18W/m	3000K			Ra>80	2880 lm/m	(1838)
	4000K				3006 lm/m	(1848)
	6500K				3006 lm/m	(18658)
20W/m	2700K			Ra>90	1560 lm/m	(2079)
	3000K				1700 lm/m	(2039)
	4000K				1840 lm/m	(2049)
	6000K				2020 Lm/m	(2069)

Dimmable*
Dim (D)
No dim (L)

Please get the corresponding **Controllers / Dimmers** from our wide range of products.

* Υποχρεωτική επιλογή / Mandatory option

Δημιουργία Κωδικού προϊόντος / Product Code generator

J30HA- length - suspension height - color - illuminant - dimmable

EXAMPLE:

J30HA - 90-120-BL-1239-D

for JAZ SUSPENDED HORIZONTAL BASE A, 90cm length, 120cm suspension height, black, 12W/m, 24VDC, 3000K, Ra90, dimmable

JAZ SUSPENDED HORIZONTAL BASE A MANUAL

ΟΔΗΓΙΕΣ ΕΓΚΑΤΑΣΤΑΣΗΣ INSTALLATION INSTRUCTIONS

ΣΗΜΑΝΤΙΚΟ:

Αυτό το εξάρτημα πρέπει να εγκατασταθεί από εξειδικευμένο ηλεκτρολόγο.

Η BarisLight δεν φέρει ευθύνη για τυχόν ζητήματα που προκύπτουν από ακατάλληλη εγκατάσταση που δεν συμμορφώνεται με τα τοπικά πρότυπα ασφαλείας.

Παρακαλούμε δώστε ένα αντίγραφο αυτών των οδηγιών στο άτομο που είναι υπεύθυνο για τη συντήρηση της εγκατάστασης.

IMPORTANT:

This luminaire must be installed by a qualified electrician.

Disclaimer:

BarisLight is not liable for any issues arising from improper installation that does not comply with local safety standards.

Instructions:

Please provide a copy of these instructions to the person responsible for maintaining the installation.

ΤΟΠΟΘΕΤΗΣΗ ΒΑΣΗΣ ΣΤΗΝ ΟΡΟΦΗ MOUNTING THE BASE TO THE CEILING

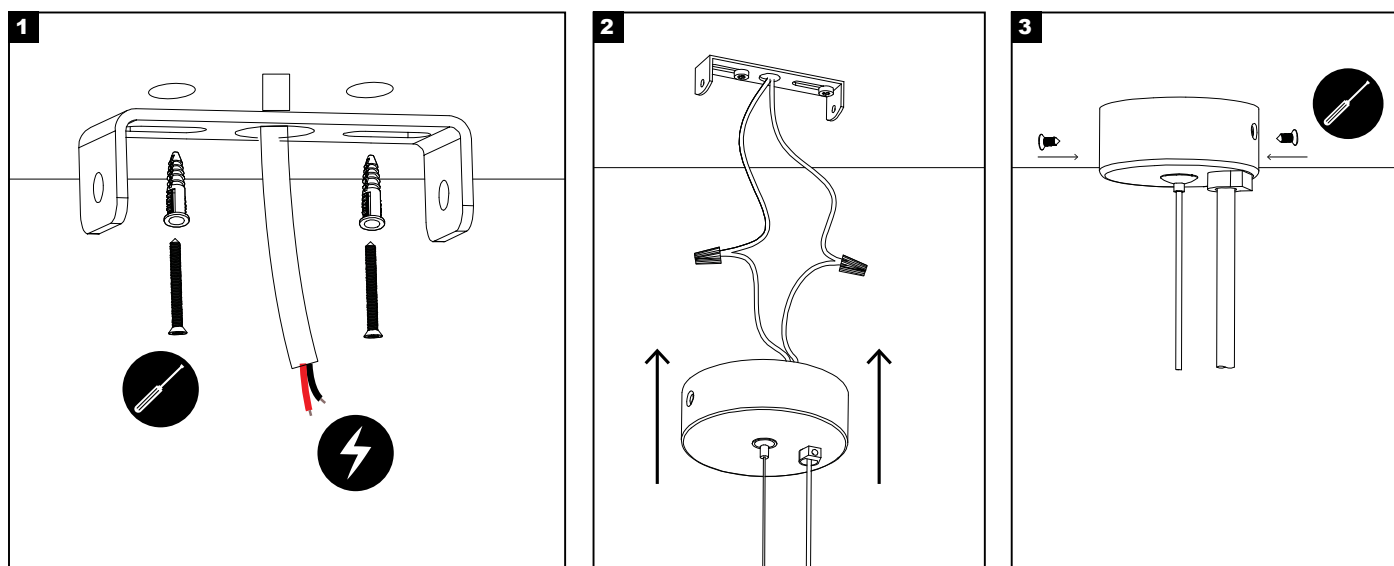

ΔΙΑΔΙΚΑΣΙΑ ΚΑΛΩΔΙΩΣΗΣ WIRING PROCEDURE

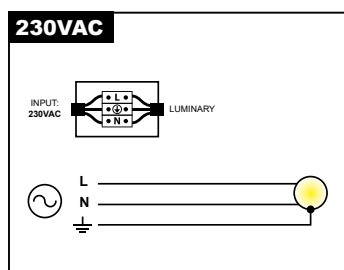

1. Κλείστε τον κεντρικό διακόπτη ρεύματος.
2. Συνδέστε τα φωτιστικά στη μονάδα παροχής ρεύματος.
3. Συνδέστε τη μονάδα τροφοδοσίας στο ηλεκτρικό δίκτυο.
4. Ενεργοποιήστε τον κεντρικό διακόπτη ρεύματος.

1. Turn off the main power switch.
2. Connect the luminaires to the power supply unit.
3. Connect the power supply unit to the electrical network.
4. Turn on the main power switch.

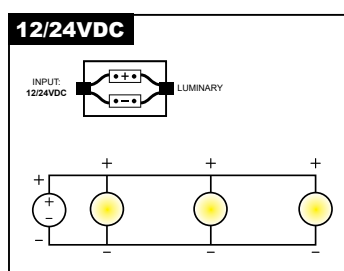

Σημείωση ασφαλείας: Βεβαιωθείτε ότι ο κεντρικός διακόπτης λειτουργίας είναι απενεργοποιημένος κατά τη διάρκεια όλων των διαδικασιών συντήρησης και εγκατάστασης.

Προειδοποίηση: Αποφύγετε τη σύνδεση πάρα πολλών φωτιστικών παράλληλα σε μία μόνο μονάδα τροφοδοσίας για να αποφευχθεί η υπερφόρτωση.

Safety Notice: Ensure the main power switch is turned off during all maintenance and installation procedures.

Warning: Avoid connecting too many luminaires in parallel to a single power supply unit to prevent overloading.

JAZ SUSPENDED HORIZONTAL BASE A MANUAL

ΤΟΠΟΘΕΤΗΣΗ ΣΤΗΝ ΟΡΟΦΗ MOUNTING TO THE CEILING

