

- Illumination of the niche and cove edge
- Easy maintenance
- Effect of a thin edge of the suspended ceiling
- Two lighting options

APPLICATION

- decorative lighting recessed in architectural niches

MOUNTING

- to the surface, using a dedicated mounting track and properly selected screws
- can be easily connected into runs and systems

ADDITIONAL INFORMATION

- standard lengths of KLUŚ profiles and covers: 1000 mm (tolerance ± 1.5 mm) and 2005 mm / 3010 mm (tolerance + 5 mm); for selected covers: 6050 mm, 10050 mm (tolerance + 5 mm)
- when choosing a different length of profiles / covers than available in the standard, you should additionally choose the cutting service at KLUŚ

TECHNICAL DRAWING

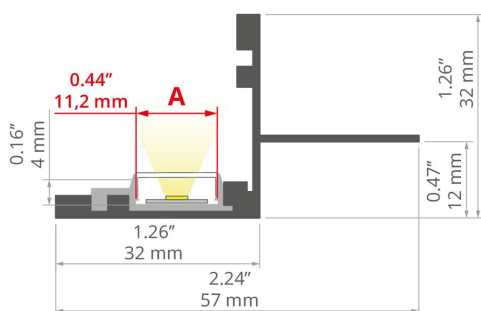

TECHNICAL SPECIFICATIONS

Material	aluminum
Color	■ silver non anodized
Possible fixture IP	20
Possible fixture shapes	linear
Profile cross-section	rectangular
Width	57 mm
Height	32 mm
LED gluing width A	11.2 mm
Number of LED strips A (8 mm wide)	1
Width of the glow	11.2 mm
Max power of a single KLUŚ LED strip	24 W/m
Closet Rated	yes
Building type	Residential, Entertainment/ Arts, HoReCa object
Facility zone	wall lighting, niche/cove, conference room
The cover is cut to the length of the profile	yes
Can be easily connected into runs	yes

Length	Ref
1000 mm	A18029N_1
2005 mm	A18029N_2
3010 mm	A18029N_3

Profile NISA-NI





Ref. A18029

Mounting to drywall	yes
To cover with plaster	yes
Wire out end cap	yes

SAMPLE PROJECTS



RELATED ACCESSORIES > COVERS

NAME	MATERIAL	MATERIAL TRANSMITTANCE	COLOR	REF.	
Cover KA-11		PC	67 %	frosted	B17064F
			89 %	clear	B17064C
Cover HS-11		PC	59 %	frosted	B17208F
			88 %	clear	B17208C
Cover LIGER-11		PC	21 %	black	B17037B
			59 %	satin	B17037S
Cover KA-T-11		PVC	54 %	frosted	B17179F
			86 %	clear	B17179C

RELATED ACCESSORIES > END CAPS

NAME	MATERIAL	COLOR	REF.
End cap ONISA	PP	 gray	C24100C02

RELATED ACCESSORIES > RELATED LED > ADJUSTABLE WHITE / DIM TO WARM

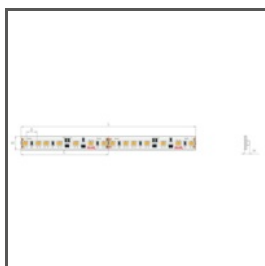

K-18D30-0960-24
K-18D30-0960-24



K-27T50-1440-24
K-27T50-1440-24

RELATED ACCESSORIES > RELATED LED > HIGH EFFICACY



K-VHE-0480-24
K-VHE-0480-24



K-VHE-0960-24
K-VHE-0960-24



K-VHE-1440-24
K-VHE-1440-24

RELATED ACCESSORIES > RELATED LED > RGB / RGB-W / RGB-CCT

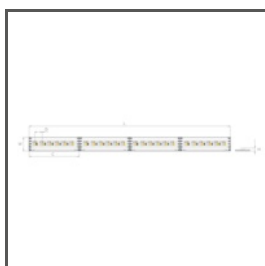

K-RGBW-1530-24
K-RGBW-1530-24

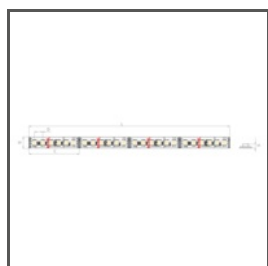

K-RGB-1920-120-24
K-RGB-1920-120-24



K-RGB-1200-24
K-RGB-1200-24



K-RGB-0700-24
K-RGB-0700-24

RELATED ACCESSORIES > RELATED LED > WHITE MONO

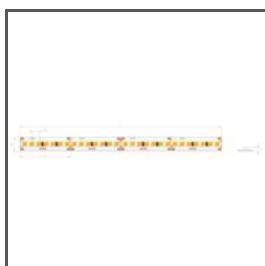

K-1910-HD-24
K-HD-1910-24



K-2300-24
K-2300-24



K-0480-24
K-0480-24

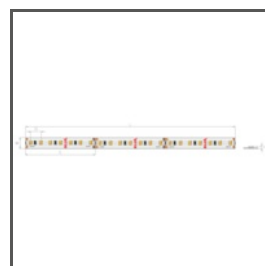

K-0960-24
K-0960-24



K-1440-24
K-1440-24

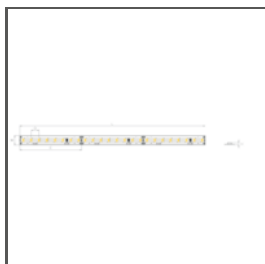

K-2400-24
K-2400-24

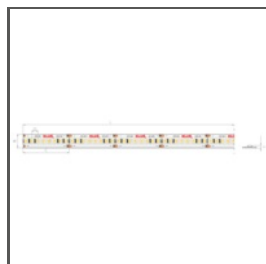

K-HD-1440-24
K-HD-1440-24



K-HD-0480-24
K-HD-0480-24

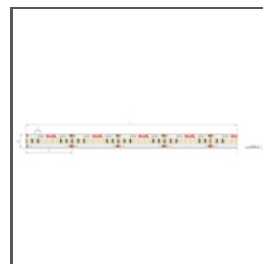

K-HD-0960-24
K-HD-0960-24

RELATED ACCESSORIES > OTHER RELATED ACCESSORIES > CONNECTORS



CONNECTOR
ZM

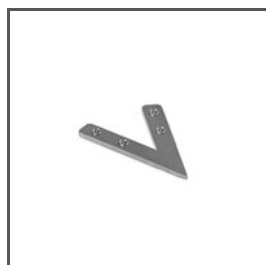

CONNECTOR
ZM-NA



CONNECTOR
ZM-PION

RELATED ACCESSORIES > OTHER RELATED ACCESSORIES > OTHER

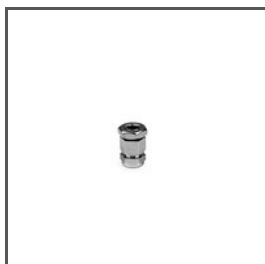

GLAND
M8x1
C42265N00



GLAND
M10x1
C28275N00

RELATED ACCESSORIES > ELECTRONICS > SWITCHES



UNI-11
E61603



UNI-P
E61580