

Profile REGULOR

Ref. A18068

Ref. arch B468+43



- Adjustable lighting angle
- Wide range of accessories

APPLICATION

- main and decorative lighting

MOUNTING

- to the surface, suspended or recessed, using dedicated accessories, properly selected screws, with double-sided adhesive tape or mounting adhesive
- easy assembly and disassembly by snapping in and out

ADDITIONAL INFORMATION

- thanks to the adjustable LED insert, the profile can be configured to obtain lighting angles of: 10, 30, 45, 60 or 90 degrees
- standard lengths of KLUŚ profiles and covers: 1000 mm (tolerance ± 1.5 mm) and 2005 mm / 3010 mm (tolerance + 5 mm); for selected covers: 6050 mm, 10050 mm (tolerance + 5 mm)
- when choosing a different length of profiles / covers than available in the standard, you should additionally choose the cutting service at KLUŚ

TECHNICAL DRAWING

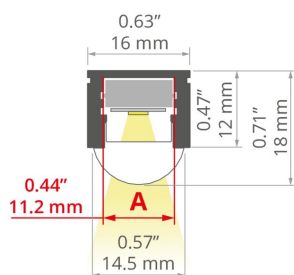

TECHNICAL SPECIFICATIONS

Material	aluminum
Color	silver anodized
Possible fixture IP	20, 67
Possible fixture shapes	linear
Width	16 mm
Height	12 mm
LED gluing width A	11.2 mm
Number of LED strips A (8 mm wide)	1
Beam angle adjustment from	10
Beam angle adjustment up to	90
Building type	Outdoor, Commercial, Retail, HoReCa object
Facility zone	urban architecture, facade lighting, wall lighting, green architecture
Easy assembly and disassembly by snapping in and out	yes
The cover is cut to the length of the profile	yes
Wire out end cap	yes

Length	Ref
1000 mm	A18068A_1 B468+43ANODA_1
2005 mm	A18068A_2 B468+43ANODA_2
3010 mm	A18068A_3 B468+43ANODA_3

Profile REGULOR

Ref. A18068

Ref. arch B468+43



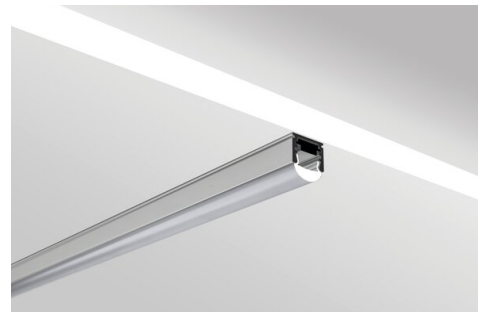

Wire out back of extrusion

yes

SAMPLE PROJECTS



RELATED ACCESSORIES > RELATED COVERS

NAME	MATERIAL	MATERIAL TRANSMITTANCE	COLOR	REF.
S	 PC	73 %	 clear	B17202T 00220
S-SATYNA	 PC	67 %	 clear	B17202S 17111

RELATED ACCESSORIES > RELATED END CAPS

NAME	MATERIAL	COLOR	REF.
REGULOR	 PP	 gray	C20116C02 00310
REGULOR-OTW	 PP	 gray	C20116C02TW 00313

RELATED ACCESSORIES > RELATED LED

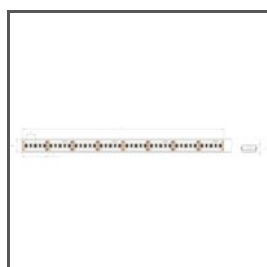

8K-WP-K-1275-12V

_błąd

Ref. arch 8K-WP-K-1275-12V

Profile REGULOR

Ref. A18068

Ref. arch B468+43

RELATED ACCESSORIES > RELATED LED > HIGH EFFICACY

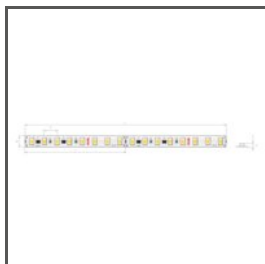

K-HE-0480-HD-24V
K-HEHD-0480-24
Ref. arch K-HE-0480-HD-24V

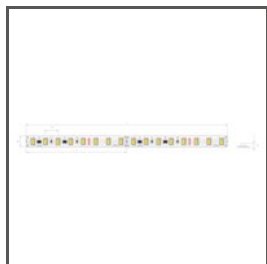

K-HE-0960-HD-24V
K-HEHD-0960-24
Ref. arch K-HE-0960-HD-24V

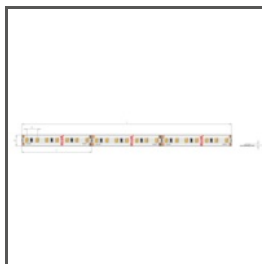

K-HE-1440-HD-24V
K-HEHD-1440-24
Ref. arch K-HE-1440-HD-24V

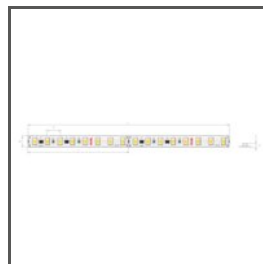

K-HE-1920-HD-24V
K-HEHD-1920-24
Ref. arch K-HE-1920-HD-24V

RELATED ACCESSORIES > OTHER RELATED ACCESSORIES > ADDITIONAL ITEMS

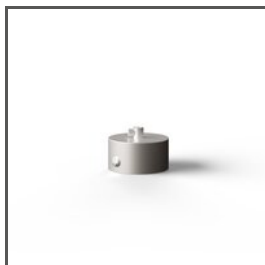

CANOPY
Fi-60mm
C24540

RELATED ACCESSORIES > OTHER RELATED ACCESSORIES > CONDUCTIVE FASTENERS AND HEADS FOR PROFILES



HEAD
ZO
C28115N00
Ref. arch 42217



FASTENER
PUSZ-PRET-MR
C28166N00, C28166L10,
C28166L07
Ref. arch 42281, 42281L9010,
42281L9005



FASTENER
PUSZ-LIN-MR
C28163N00, C28163L10,
C28163L07
Ref. arch 42278, 42278L9010,
42278L9005



FASTENER
FI-8-LIN-MR
C28172N00, C28172L10,
C28172L07
Ref. arch 42287, 42287L9010,
42287L9005

RELATED ACCESSORIES > OTHER RELATED ACCESSORIES > FASTENERS AND HEADS FOR PROFILES



HEAD
ST
C28114N00
Ref. arch 42216



HEAD
BZP
C28113N00
Ref. arch 42213

Profile REGULOR

Ref. A18068

Ref. arch B468+43

RELATED ACCESSORIES > OTHER RELATED ACCESSORIES > MOUNTING BRACKETS



MOUNTING BRACKET

PDS-STN
C24190N00
Ref. arch 24190



MOUNTING BRACKET

REG-PD-UV
C28055C02
Ref. arch 24270



MOUNTING BRACKET

PL-PDM
C24041C02
Ref. arch 24041



MOUNTING BRACKET

PDS
C24189C02, C24223C10
Ref. arch 24189, 24223



MOUNTING BRACKET

PDS-STN-90G
C24370N00, C24370L07,
C24370L10
Ref. arch 24370, 24370RAL9005,
24370RAL9010

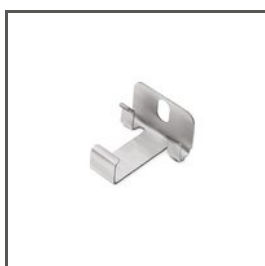

MOUNTING BRACKET

PDS-STN-90D
C24367N00, C24367L07,
C24367L10
Ref. arch 24367, 24367RAL9005,
24367RAL9010



MOUNTING BRACKET

PDS-STN-ALFA
C28060N00
Ref. arch 24426



NEW

MOUNTING BRACKET

PDS-STN-45D
C24456N00
Ref. arch 24456



NEW

MOUNTING BRACKET

PDS-STN-60D
C24457N00
Ref. arch 24457

RELATED ACCESSORIES > OTHER RELATED ACCESSORIES > OTHER



GLAND

6x1,2
C24517C07
Ref. arch 00802

RELATED ACCESSORIES > OTHER RELATED ACCESSORIES > SUSPENSION AND MOUNTING SETS



ARM

K5G-AB
C28270N00
Ref. arch 42051



FASTENER SET

W1
C28203N00
Ref. arch 42602



FASTENER SET

W2
C28204N00
Ref. arch 42603



FASTENER SET

M3
C28182N00
Ref. arch 42303



FASTENER SET

M4
C28180N00
Ref. arch 42301

Profile REGULOR

Ref. A18068

Ref. arch B468+43



FASTENER SET

M5

C28181N00
Ref. arch 42302

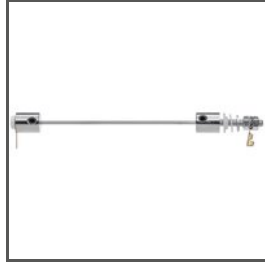

FASTENER SET

W6

C28205N00
Ref. arch 42604

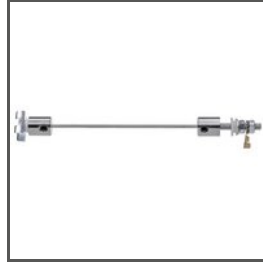

FASTENER SET

W9

C28207N00
Ref. arch 42607

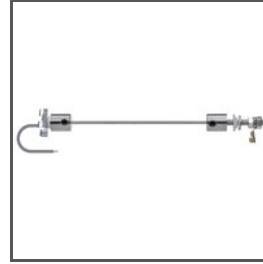

FASTENER SET

W10

C28208N00
Ref. arch 42608



FASTENER SET

RG-1

C28230P00, C28230P01,
C28230L10, C28230L07
Ref. arch 42647NI, 42647GSS,
42647L9010, 42647L9005