

### Parts needed to mount the TEPIKO and PIKO-ZM profile



Mounting strip (A)



Profile (B)



Small end cap (C)



Large end cap (D)



Protective insert (E)



Cover (F)



LED Strip (G)



Clip (H)

### Materials and tools needed for mounting:

- glue
- gypsum
- paint
- driller

**NOTE!** All LED strips must be connected to a 12 V or 24 V power supply.

**IMPORTANT:** The manual presents the simplest mounting procedure. More mounting procedures and related accessories can be found at [klusdesign.eu](http://klusdesign.eu)

**1.** Drill a hole in the mounting strip (A).

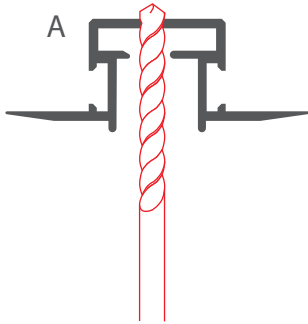

**2.** Insert the large end cap (D) into the mounting strip (A), and then place the protective insert (E) in it.

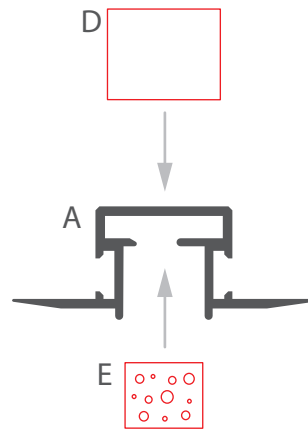

**3.** Connect the power cable and run it through the hole drilled in the mounting strip. Attach the strip to the mounting surface with glue.

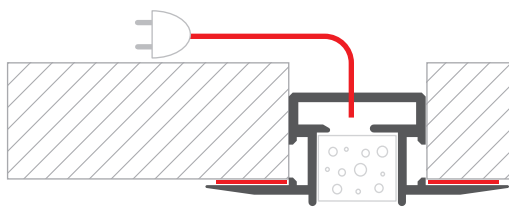

**4.** Apply plaster finish, covering the wings of the mounting strip. The protective insert protects the inside.

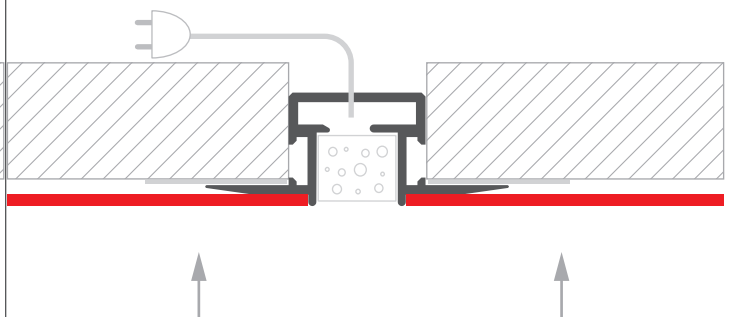

**5.** Remove the protective insert (E).

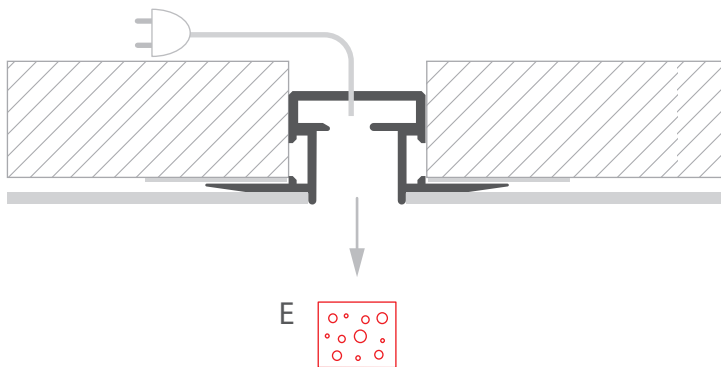

**6.** Drill a hole for the power cable in the profile (B).



**7.** Insert the clip (H) into the profile (B).

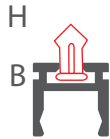

**8.** Attach the LED strip (G) with the power cable in the profile (B) using glue. Insert the cover (F) and small end caps (C).

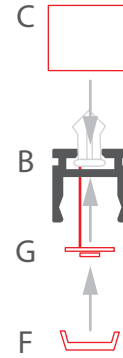

**9.** Snap the assembled lighting fixture in the mounting strip.

