

# RAY DOT

## ΠΕΡΙΕΧΟΜΕΝΑ | CONTENTS

Datasheet ..... 1  
Manual ..... 4

SKU: RAYDT25-XX-XX-XX-XX-XX-XX-XX-XX-XX-XX-XX-XX

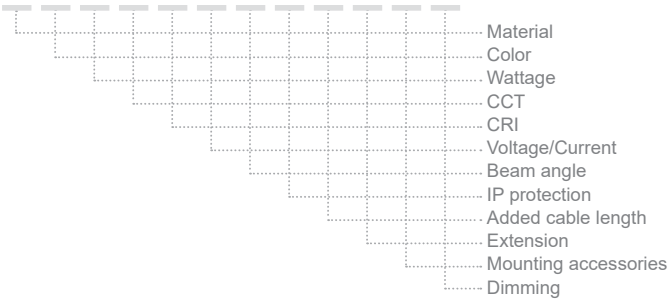

## DATASHEET





### GENERAL INFORMATION

APPLICATION:	Indoor / Outdoor
MOUNTING SURFACE:	Ceiling / Wall / Ground
MOUNTING TYPE:	Surface mounted
DIMENSIONS:	Ø25 × L30 mm
TILTABLE:	-100° ~ +100°
CABLE INCLUDED:	30 cm
DRIVER INCLUDED:	No
LED:	Cree / OSRAM
LIFETIME:	50000 hours
WARRANTY:	3 years (*5 years upon request)
ORIGIN:	GR









### CONFIGURATION OPTIONS

#### \*MATERIAL:

Aluminium	(01)	
Inox	(02)	
Brass	(03)	

#### \*COLOR:

Anodised (Aluminium only)	(AN)	
Black	(BL)	
White	(WH)	
Graphite	(GF)	
RAL colors	(RL)	
Patina	(PT)	
No color	(NO)	

#### \*WATTAGE:

0.5W	(0.5W)
1W	(1W)
2W	(2W)
2.5W	(2.5W)
3W	(3W)

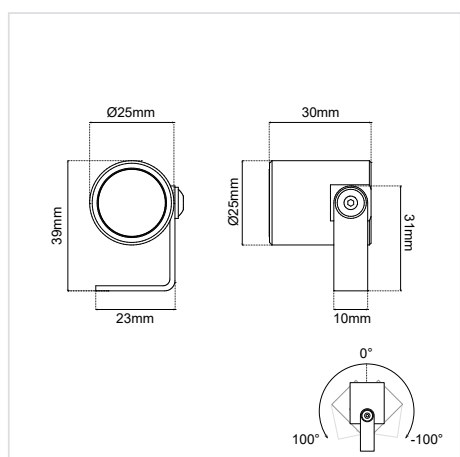

Continued on next page →





# RAY DOT

SKU: RAYDT25-XX-XX-XX-XX-XX-XX-XX-XX-XX-XX-XX-XX-XX-XX-XX









MATERIAL  
COLOR  
WATTAGE  
CCT  
CRI  
BEAM ANGLE  
VOLTAGE/CURRENT  
IP PROTECTION  
ADDED CABLE LENGTH  
EXTENSION  
MOUNTING ACCESSORIES  
DIMMING

## CONFIGURATION OPTIONS (cont.)

### EXTENSION:

Without Extension		(WE)	
Branch		Branch with Base R40×27mm	
			
Height:		Height:	
130mm	(H13)	130mm	(H13MB1)
300mm	(H30)	300mm	(H30MB1)
400mm	(H40)	400mm	(H40MB1)
500mm	(H50)	500mm	(H50MB1)
600mm	(H60)	600mm	(H60MB1)
700mm	(H70)	700mm	(H70MB1)
800mm	(H40)	800mm	(H40MB1)
900mm	(H90)	900mm	(H90MB1)
1000mm	(H100)	1000mm	(H100MB1)

### MOUNTING ACCESSORIES:

Pole D10×200mm Brass	(PL1)	
Pole D10×600mm Brass	(PL2)	
Pole D10×1000mm Brass	(PL3)	
Pole D10×200mm Brass with Base R80	(PL4)	
Pole D10×600mm Brass with Base R80	(PL5)	
Pole D10×1000mm Brass with Base R80	(PL6)	
Spike D32x150mm Aluminium	(SP)	
Strap-mount for tree branch	(TU)	

### \*DIMMING:

Dimmable	(D)
Dim DALI Push	(DDP)
Dim TRIAC (24V)	(D1)
On/Off	(L)

Please also obtain the corresponding Controllers / Dimmers from our wide range of available options.

\* Υποχρεωτική επιλογή / Mandatory option

ΔΗΜΙΟΥΡΓΙΑ ΚΩΔΙΚΟΥ ΠΡΟΪΟΝΤΟΣ / PRODUCT CODE GENERATOR:

RAYDT25 - Material - Color - Wattage - CCT - CRI - Voltage/current - IP protection - Added cable length - Extension - Mounting accessories - Dimming

ΠΑΡΑΔΕΙΓΜΑ / EXAMPLE:

RAYDT25-01-AN-2W-30K-90-V2-65-NAC-\_\_

for Ray Dot, Aluminium, Anodized, 2W, 3000K, 24VDC, IP65, No added cable, On/Off

## RAY DOT MANUAL

### ΟΔΗΓΙΕΣ ΕΓΚΑΤΑΣΤΑΣΗΣ INSTALLATION INSTRUCTIONS

#### ΣΗΜΑΝΤΙΚΟ:

Αυτό το εξάρτημα πρέπει να εγκατασταθεί από εξειδικευμένο ηλεκτρολόγο.

Η BarisLight δεν φέρει ευθύνη για τυχόν ζητήματα που προκύπτουν από ακατάλληλη εγκατάσταση που δεν συμμορφώνεται με τα τοπικά πρότυπα ασφαλείας.

Παρακαλούμε δώστε ένα αντίγραφο αυτών των οδηγιών στο άτομο που είναι υπεύθυνο για τη συντήρηση της εγκατάστασης.

#### IMPORTANT:

This luminaire must be installed by a qualified electrician.

#### Disclaimer:

BarisLight is not liable for any issues arising from improper installation that does not comply with local safety standards.

#### Instructions:

Please provide a copy of these instructions to the person responsible for maintaining the installation.

### Εφαρμογή στην επιφάνεια Application on the surface

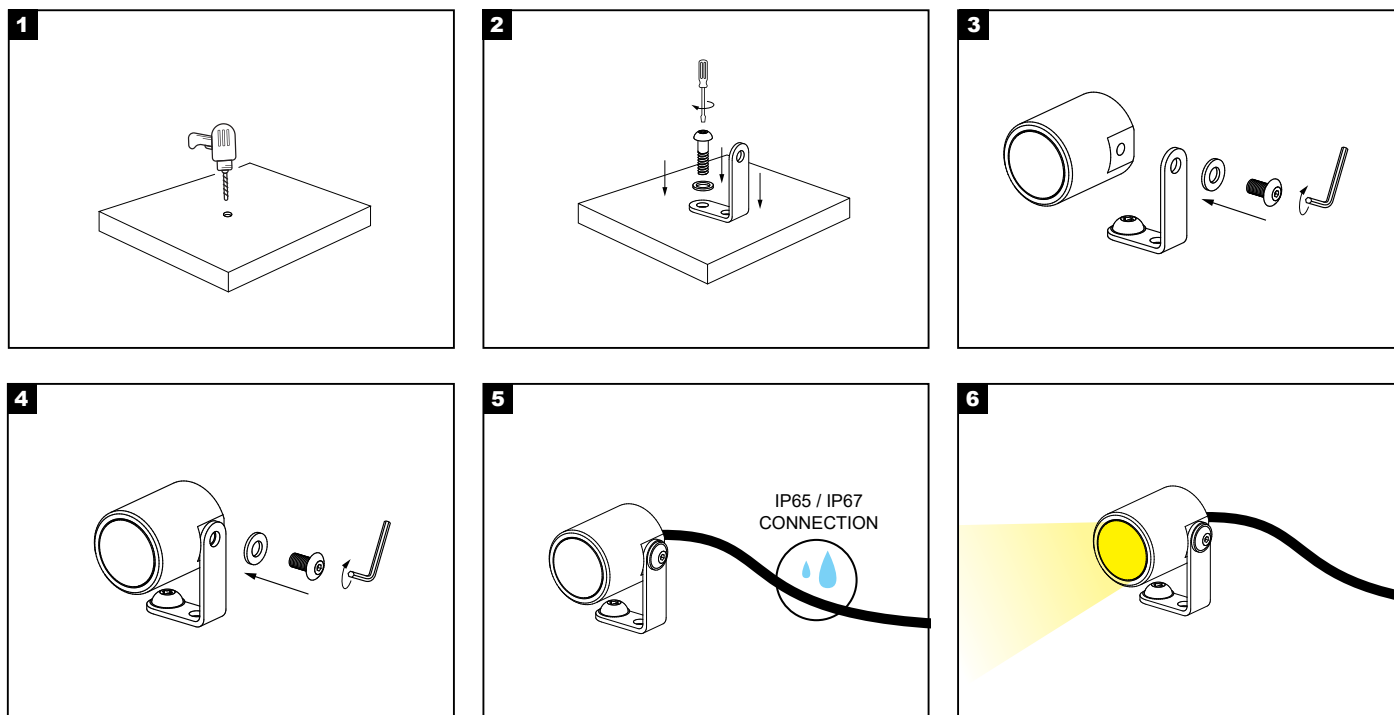

## RAY DOT MANUAL

### ΣΥΝΔΕΣΗ ΜΕ ΤΗΝ ΗΛΕΚΤΡΙΚΗ ΠΑΡΟΧΗ CONNECTION TO THE ELECTRICAL SUPPLY

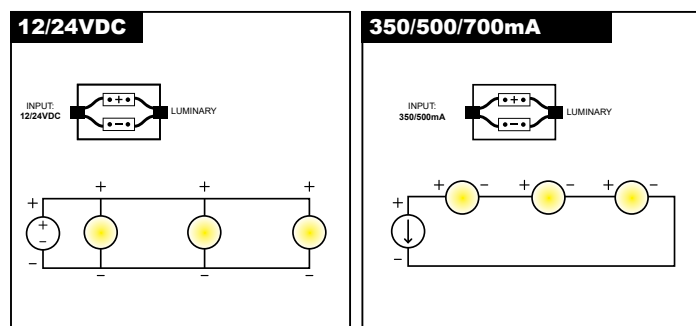

#### Διαδικασία καλωδίωσης

1. Κλείστε τον κεντρικό διακόπτη ρεύματος.
2. Συνδέστε τα φωτιστικά στη μονάδα παροχής ρεύματος.
3. Συνδέστε τη μονάδα τροφοδοσίας στο ηλεκτρικό δίκτυο.
4. Ενεργοποιήστε τον κεντρικό διακόπτη ρεύματος.

**Σημείωση ασφαλείας:** Βεβαιωθείτε ότι ο κεντρικός διακόπτης λειτουργίας είναι απενεργοποιημένος κατά τη διάρκεια όλων των διαδικασιών συντήρησης και εγκατάστασης.

**Προειδοποίηση:** Αποφύγετε τη σύνδεση πάρα πολλών φωτιστικών παράλληλα σε μία μόνο μονάδα τροφοδοσίας για να αποφευχθεί η υπερφόρτωση.

#### Wiring Procedure

1. Turn off the main power switch.
2. Connect the luminaires to the power supply unit.
3. Connect the power supply unit to the electrical network.
4. Turn on the main power switch.

**Safety Notice:** Ensure the main power switch is turned off during all maintenance and installation procedures.

**Warning:** Avoid connecting too many luminaires in parallel to a single power supply unit to prevent overloading.

## RAY DOT MANUAL

### Εναλλακτικοί τρόποι τοποθέτησης Alternative application methods

#### Pole D10×200-1000mm Brass (PL1 / PL2 / PL3)

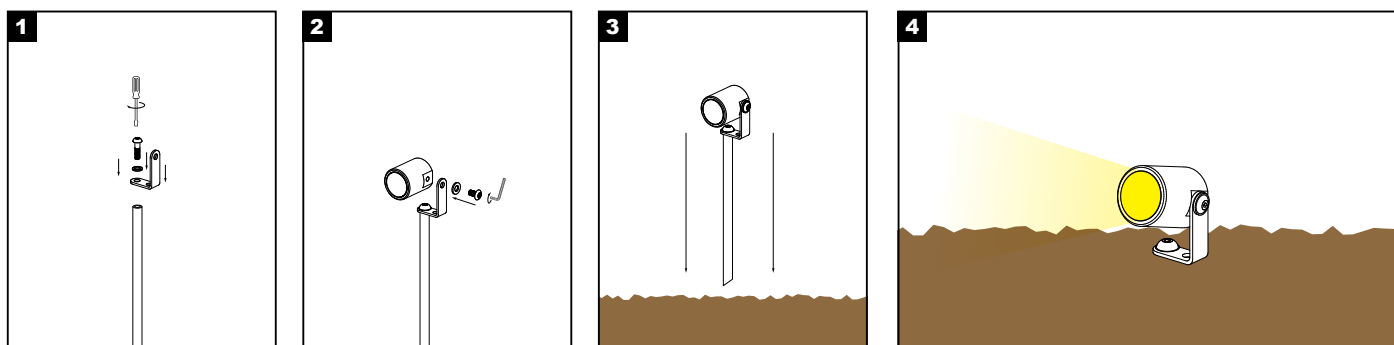

#### Pole D10x200mm Brass with base (PL4 / PL5 / PL6)

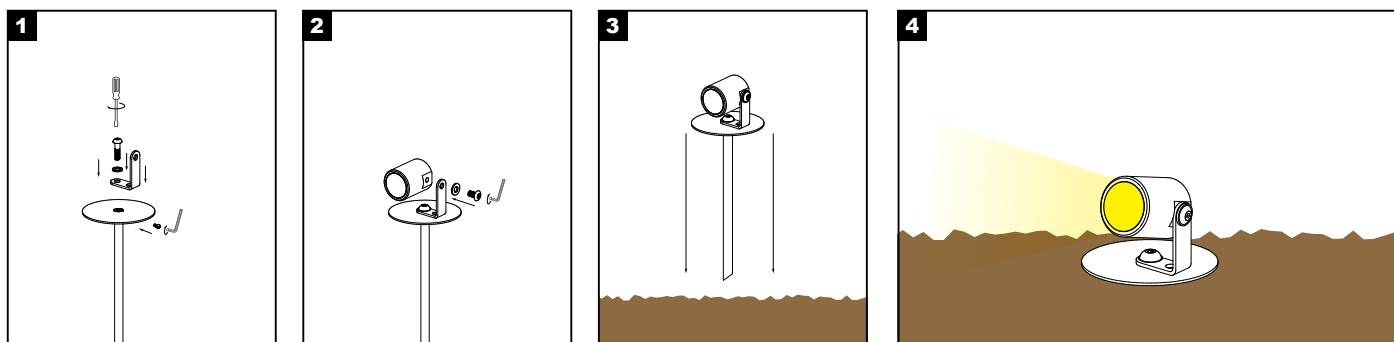

#### Spike D32x150mm Aluminium (SP)

