

LINEAR CEILING 4L

ΠΕΡΙΕΧΟΜΕΝΑ | CONTENTS

Datasheet	1
Lumen output tables	3
Manual	4

SKU: 35CL-XX-XX-XX-XX-XX-XX

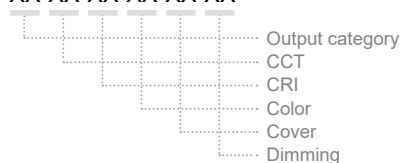

DATASHEET





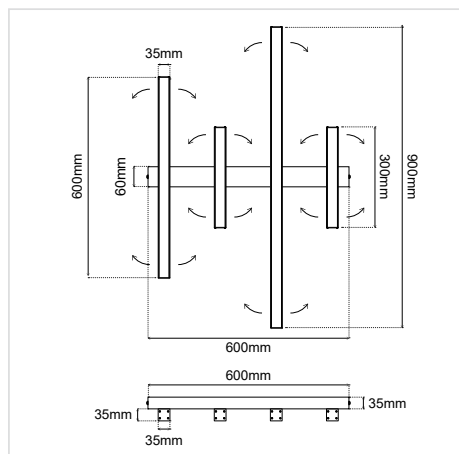
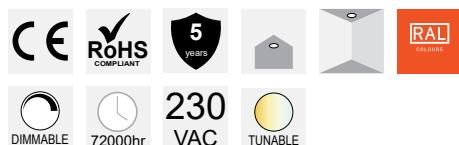

GENERAL INFORMATION

APPLICATION:	Indoor
MOUNTING SURFACE:	Ceiling
MOUNTING TYPE:	Surface mounted
MATERIAL:	Extruded aluminium / Plastic
PCB DETAILS:	Zhaga-Compliant Dimensions
LINEAR MODULE DIMENSIONS (W×H):	35 × 35mm
LINEAR MODULE LENGTHS:	600mm / 300mm / 900mm / 300mm
BASE DIMENSIONS (W×H×L):	60 × 35× 600mm
IP RATING:	IP20
VOLTAGE:	230VAC
LUMEN OUTPUT / W:	Up to 195 lm/W
LIFETIME:	72000 hours
WARRANTY:	5 years
ORIGIN:	Greece



CONFIGURATION OPTIONS

*ΚΑΤΗΓΟΡΙΑ ΑΠΟΔΟΣΗΣ:
*OUTPUT CATEGORY:

13,5 W/m	(1A)	
20 W/m	(1B)	
40,5 W/m	(2A)	
60,5 W/m	(2B)	

Ανατρέξτε στους πίνακες απόδοσης και διαλέξτε την απόδοση που απαιτεί ο χώρος σας. Η ισχύς προκύπτει από την κατηγορία απόδοσης (1A, 1B, 2A, 2B) και από τη θερμοκρασία φωτός (3000K, 4000K, 5000K, 6500K) που θα επιλέξετε.

Refer to the Lumen Output Tables and choose the output that your space requires. Wattage follows from the output category (1A, 1B, 2A, 2B) and the Color temperature (3000K, 4000K, 5000K, 6500K) you choose.

Continued on next page →

LINEAR CEILING 4L

SKU: **35CL**- XX-XX-XX-XX-XX-XX

OUTPUT CATEGORY
CCT
CRI
COLOR
COVER
DIMMING

CONFIGURATION OPTIONS (cont.)

*ΘΕΡΜΟΚΡΑΣΙΑ ΦΩΤΟΣ (CCT):

*COLOR TEMPERATURE (CCT):









3000K warm white	(30K)	
4000K neutral white	(40K)	
5000K cool white	(50K)	
6500K ultra cool white	(65K)	
TUNABLE 2700K - 6500K	(TN)	

*CRI:

Ra80	(80)
Ra90	(90)



*ΧΡΩΜΑ:

*COLOR

Anodised	(AN)	
Black	(BL)	
White	(WH)	
Graphite	(GF)	
RAL colors	(RL)	
Patina	(PT)	
Nickel plating (upon request)	(NK)	
No color	(NO)	

*ΚΑΛΥΜΜΑ:

*COVER:

Diffuser 1.5mm	(CD1.5)	
Microprismatic 3mm	(CM3)	

*ΑΥΞΟΜΕΙΩΣΗ ΕΝΤΑΣΗΣ ΦΩΤΟΣ:

*DIMMING OPTIONS:

Dim DALI Push	(DDP)
Dim DALI	(DD)
Casambi	(DSI)
Analog 0/1-10V	(DNG)
On/Off	(L)

* Υποχρεωτική επιλογή / Mandatory option

ΔΗΜΙΟΥΡΓΙΑ ΚΩΔΙΚΟΥ ΠΡΟΪΟΝΤΟΣ / PRODUCT CODE GENERATOR:

35CL - Output category - CCT - CRI - Color - Cover - Dimming

ΠΑΡΑΔΕΙΓΜΑ / EXAMPLE:

35CL-1A-30K-90-BL-CD1.5-DD

for Linear Ceiling 4L, 13,5 W/m, 3000K, Ra90, Black, Diffuser 1.5mm, Dim DALI

LINEAR CEILING 4L LUMEN OUTPUT TABLES

CATEGORY 1A 350mA (1A)	Module Length	Wattage	Lumens 3000K	Lumens 4000K	Lumens 5000K	Lumens 6500K
	31cm	4	695	735	735	720
	46cm	6	1043	1103	1103	1080
	60cm	7.8	1390	1470	1470	1440
	74cm	9.8	1738	1838	1838	1800
	88cm	11.7	2085	2205	2205	2160
	102cm	13.7	2433	2573	2573	2520
	116cm	15.6	2780	2940	2940	2880

Wattage: 20 W/m

CATEGORY 1B 500mA (1B)	Module Length	Wattage	Lumens 3000K	Lumens 4000K	Lumens 5000K	Lumens 6500K
	31cm	5,8	980	1035	1035	1010
	46cm	8,7	1470	1553	1553	1515
	60cm	11.6	1960	2070	2070	2020
	74cm	14.5	2450	2588	2588	2525
	88cm	17.4	2940	3105	3105	3030
	102cm	20.3	3430	3623	3623	3535
	116cm	23.2	3920	4140	4140	4040

Wattage: 20 W/m

CATEGORY 2A 350mA (2A)	Module Length	Wattage	Lumens 3000K	Lumens 4000K	Lumens 5000K	Lumens 6500K
	31cm	11.8	2040	2190	2190	2040
	46cm	17.7	3060	3285	3285	3060
	60cm	23.6	4080	4380	4380	4080
	74cm	29.5	5100	5475	5475	5100
	88cm	35.4	6120	6570	6570	6120
	102cm	41.3	7140	7665	7665	7140
	116cm	47.2	8160	8760	8760	8160

Wattage: 20 W/m

CATEGORY 2B 500mA (2B)	Module Length	Wattage	Lumens 3000K	Lumens 4000K	Lumens 5000K	Lumens 6500K
	31cm	17.5	2850	3070	3070	2850
	46cm	26.3	4275	4605	4605	4275
	60cm	35	5700	6140	6140	5700
	74cm	43.8	7125	7675	7675	7125
	88cm	52.5	8550	9210	9210	8550
	102cm	61.3	9975	10745	10745	9975
	116cm	70	11400	12280	12280	11400

Wattage: 20 W/m

LINEAR CEILING 4L MANUAL

ΟΔΗΓΙΕΣ ΕΓΚΑΤΑΣΤΑΣΗΣ INSTALLATION INSTRUCTIONS

ΣΗΜΑΝΤΙΚΟ:

Αυτό το εξάρτημα πρέπει να εγκατασταθεί από εξειδικευμένο ηλεκτρολόγο.

Η BarisLight δεν φέρει ευθύνη για τυχόν ζητήματα που προκύπτουν από ακατάλληλη εγκατάσταση που δεν συμμορφώνεται με τα τοπικά πρότυπα ασφαλείας.

Παρακαλούμε δώστε ένα αντίγραφο αυτών των οδηγιών στο άτομο που είναι υπεύθυνο για τη συντήρηση της εγκατάστασης.

ΣΥΝΔΕΣΗ ΜΕ ΤΗΝ ΗΛΕΚΤΡΙΚΗ ΠΑΡΟΧΗ CONNECTION TO THE ELECTRICAL SUPPLY

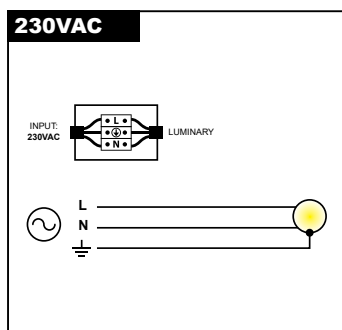

Διαδικασία καλωδίωσης

1. Κλείστε τον κεντρικό διακόπτη ρεύματος.
2. Συνδέστε τα φωτιστικά στη μονάδα παροχής ρεύματος.
3. Συνδέστε τη μονάδα τροφοδοσίας στο ηλεκτρικό δίκτυο.
4. Ενεργοποιήστε τον κεντρικό διακόπτη ρεύματος.

Σημείωση ασφαλείας: Βεβαιωθείτε ότι ο κεντρικός διακόπτης λειτουργίας είναι απενεργοποιημένος κατά τη διάρκεια όλων των διαδικασιών συντήρησης και εγκατάστασης.

Προειδοποίηση: Αποφύγετε τη σύνδεση πάρα πολλών φωτιστικών παράλληλα σε μία μόνο μονάδα τροφοδοσίας για να αποφευχθεί η υπερφόρτωση.

IMPORTANT:

This luminaire must be installed by a qualified electrician.

Disclaimer:

BarisLight is not liable for any issues arising from improper installation that does not comply with local safety standards.

Instructions:

Please provide a copy of these instructions to the person responsible for maintaining the installation.

Wiring Procedure

1. Turn off the main power switch.
2. Connect the luminaires to the power supply unit.
3. Connect the power supply unit to the electrical network.
4. Turn on the main power switch.

Safety Notice: Ensure the main power switch is turned off during all maintenance and installation procedures.

Warning: Avoid connecting too many luminaires in parallel to a single power supply unit to prevent overloading.

LINEAR CEILING 4L MANUAL

ΤΟΠΟΘΕΤΗΣΗ ΣΤΗΝ ΟΡΟΦΗ INSTALLATION ON THE CEILING

